

UGMIT RAYAGADA

Lecture Note

Of

ACTE, 6th Sem.

Prepared by

Chinmaya Maharana,

PTGF (Civil)

Ch. 1 ADVANCED CONSTRUCTION MATERIALS

Fibers: -

Fiber or fibers is a class of material which are having continuous filaments or having discrete elongated pieces similar to the length of thread.



There are mainly three types of fibers which are commonly used as a construction material.

- Steel fiber
- Carbon fiber
- Glass fiber

Steel fiber: -

- Steel fiber are made from the cold drawn steel wire with low content of carbon or stainless-steel wire.
- They are manufactured in various types such as hooked steel fibers, undulated or flat steel fibers according to the need required in the construction project.
- These fibers are used in the construction for concrete reinforcement.
- Steel fiber reinforced concrete is less expensive than hand tied re-bar. Shape, dimensions and length of the fiber are more important because it increases the tensile strength of the concrete.
- Fiber-reinforced normal concrete is mostly used for on-ground floors and pavements and also used for the construction parts such as beams, pillars, foundation etc.

Properties: -

- It increases the tensile strength of concrete.
- It is more tough and hard.
- It avoids corrosion and rust stains.
- They are more elastic in nature.
- Steel fibers are available with standards as ASTM 820/96, ASTM C 1116/95 and DIN 1045.
- It has a tensile strength of 1100 N/mm².

- They are available in the shapes like flat, hooked and undulated.

Applications/uses: -

- Steel fibers are highly used in tunnel lining work.
- It is mostly used in the construction of airport runways and highway pavements.
- Most commonly used in precast concrete so as to increase the tensile strength.
- They are used in shotcrete.
- Used in the construction of parking.
- It is used in anti-seismic buildings.

Carbon fibers: -

- Carbon fiber is a material consisting of extremely thin fibers about 0.005 mm to 0.010 mm in diameter and mostly composed of carbon atoms.
- Carbon fiber is alternately called graphite fiber.
- The carbon atoms are bonded together in microscopic crystals which are more or less aligned parallel to the long axis of the fiber. The crystal alignment makes size of fiber stronger. Number of carbon fibers are twisted together so as to form a Yarn which can be used as it exists or woven into a fabric.
- It can be combined with a plastic resin and wound or moulded to form composite materials like carbon fiber reinforced plastic to provide a high strength to weight ratio of the materials.

Properties: -

- It has a high tensile strength, low weight and low thermal expansion.
- They are rigid materials which are resistant to stretching and compression.
- It is chemically inert or unreactive materials.
- They are resistant to corrosion.
- Fibers contained about 85% carbon has excellent flexural strength.

Applications/uses: -

- Carbon fiber is mostly used to reinforce composite material.
- Reinforced Carbon-Carbon (RCC) consists of carbon fiber-reinforced graphite and is used structurally in high temperature applications.
- It increases the tensile as well as compressive strength of concrete.
- Due to high tensile strength, low weight and low thermal expansion it makes the carbon fiber very popular in aerospace, military and motorsports along with other competition sports.

- Carbon fiber is extensively used in the bicycle industry, especially for high-performance racing bikes.
- It is also used in some tennis rackets.
- It is now being used in musical instruments for its weather resilience and ability to recreate the tone of guitars.

Glass fibers: -

- It is also called as fiber glass. Glass fiber is the material made from extremely fine fibers of glass.
- It was invented in 1938 by Russell Games Slayter.
- The fresh and thin fibers are stronger because the thinner fibers are more ductile.

Properties: -

- It has high ratio of surface area to weight.
- They have good thermal insulation.
- It has a good tensile strength but has no strength against compression.
- Compressive strength is weak but can be increased by reinforcing it with plastic.
- When the glass fiber is reinforced with plastic, then reinforced material can resist both compressive and tensile forces as well.
- It is resistant to chemical attack. However, if its surface area is increased, then it makes them more susceptible to chemical attack.
- They are corrosion resistant.

Applications/uses: -

- Corrugated fiber glass panels are widely used for outdoor canopy or greenhouse construction.
- It is used as a reinforcing agent for many polymer products like FRP and GRP which uses tubes, pipes for drinking water and 'sewers, office plant containers and flat roof systems etc.
- It is reinforced with plastic material so as to increase tensile strength.
- Uses of regular fiber glass are mats, insulation, reinforcement sound absorption, heat resistance fabrics, corrosion resistant fabrics and high strength fabrics.
- Glass fiber reinforced plastics are used in the house building market for the production of roofing laminate, door surrounds, over-door canopies, window canopies and dormers, chimneys, coping system, heads with keystone and sill etc.
- The reinforced glass fiber with polymer and plastic is commonly used in fire water systems, cooling water systems, drinking water systems, sewage systems, waste water systems, gas system etc.

Plastics: -

- Plastic is an organic material prepared out of resin.
- Plastic may be defined as a natural or synthetic organic material which are having the property of being plastic at some stage of their manufacture when they can be moulded to required size and shape.
- The typical uses of plastics in buildings are listed below:
 1. Corrugated and plain sheets for roofing.
 2. For making jointless flooring.
 3. Flooring tiles.
 4. Overhead water tanks.
 5. Bath and sink units.
 6. Cistern hall floats.
 7. Decorative laminates and mouldings.
 8. Window and door frames and shutters for bathroom doors.
 9. Lighting fixtures.
 10. Electrical conduits.
 11. Electrical insulators.
 12. Pipes to carry cold waters.
- Primarily there are two types of plastics
 - Thermoplastic
 - Thermosetting plastics

Thermoplastics: -

- In this variety, the linkage between the molecules is very loose. They can be softened by heating repeatedly. These are also called reversible plastics.
- This property helps for reuse of waste plastic.
- Bitumen, cellulose and shellac are the examples of this variety of plastics.

Thermosetting plastics: -

- Thermosetting plastics are made up from long chains of molecules that are cross-linked.
- They have a very rigid structure.
- Once heated, thermosetting plastics can be moulded, shaped and pressed into shapes. Once set they cannot be reheated since they are permanently set. These are also called irreversible plastics.
- The scrap of such plastic is not reusable.
- Bakelite is an example of such plastic.

Types of plastics: -

PVC: -

- PVC is Polyvinyl Chloride.
- PVC are tough and exceptionally resistant to chemical attack
- PVC require protection from ultraviolet exposure if installed outdoor and start softening when subjected to high temperature.
- PVC Pipes are made by an Extrusion process and Fittings, flanges, and valves are manufactured by injection molding method
- PVC has many applications in industries and it's also used in home water piping.
- PVC is replacing traditional building materials like wood, metal, concrete and clay in many applications due to its versatility and cost effectiveness.

RPVC: -

- RPVC means Rigid PolyVinyl Chloride.
- PVC comes in two basic forms: flexible and rigid (RPVC). RPVC is used in construction (especially pipes), packaging (especially bottles), and credit cards, just to list a few examples.
- These are Strong & durable
- These are flexible, light-weight & hence easy to transport
- These require easy installation & low maintenance
- These are high electrical & chemical resistance
- These are termite proof & UV resistant
- These are manufactured conforming to IS 4985:2000 standards
- These are resistant to moisture, abrasion & wearing
- RPVC applications include Saltwater handling, Potable water supply schemes in urban areas, Acid & slurry transportation, Disposal of chemical effluent & waste etc.

HDPE: -

- HDPE plastic better known as High-density polyethylene is a polyethylene thermoplastic created from petroleum. Also known as alkathene or polythene when used for pipes.
- HDPE is commonly used to produce items like plastic bottles and cutting boards.
- HDPE is made when intense heat is applied to petroleum. Also known as cracking, this process creates ethylene gas. At this stage of production, the gas molecules will then attach forming polymers---which in turn, produce polyethylene.
- HDPE is commonly used to create containers like milk and water jugs.
- HDPE is also very flexible and strong.

- HDPE is resistant to corrosion and lightweight, making it an ideal option when compared to other types of plastic.
- It is easy to recycle
- It also used as lined material with carbon steel pipe

FRP: -

- Fiber Reinforced Polymer (FRP) composite is defined as a polymer that is reinforced with fiber. Fibers may be carbon, glass etc.
- FRP composites are anisotropic. Therefore, their properties are directional, meaning that the best mechanical properties are in the direction of the fiber placement.
- These materials have a high ratio of strength to density, exceptional corrosion resistance and convenient electrical, magnetic and thermal properties. However, they are brittle and their mechanical properties may be affected by the rate of loading, temperature and environmental conditions.
- The primary function of fiber reinforcement is to carry the load along the length of the fiber and to provide strength and stiffness in one direction.
- Fiber + polymer matrix = FRP
- Used in prestressed concrete, underwater piping and structural parts of offshore platform, as internal reinforcement for concrete structures, for strengthening of various structures constructed from concrete, masonry, timber, and even steel, for seismic retrofitting etc.

GRP: -

- Glass-reinforced plastic (GRP) is a composite material consisting of plastic reinforced with fine glass fibers. These fibers may be arranged randomly, flattened as a sheet, or woven to make a fabric-like material.
- A plastic resin is then overlaid onto the glass fibers to create combined uniform material. This resin may include epoxy, vinyl ester, polyester, polyurethane, or polypropylene.
- The glass fibers in GRP are cheaper, more flexible, and lighter than their carbon counterpart, making it an ideal reinforcing agent for many polymer products.
- Additionally, glass fibers are also non-magnetic, corrosion-resistant, resistant to electromagnetic radiation, and chemically inert under specific circumstances. These properties make GRP materials an ideal material for structures and components, such as: Aircraft, boats, automobiles, water tanks, roofing, oil and gas lift systems etc.

Artificial timbers: -

- The timber which is converted in a factory by some mechanical processes is termed as 'Artificial timber' or 'Industrial timber'.
- Such timber possesses desired shape, appearance, strength and durability. Following are some varieties of artificial timbers.

- 1) Plywood
- 2) Veneer
- 3) Fibreboard
- 4) Block board
- 5) Particle board
- 6) Flush door

The use of artificial timber is justified over natural timber for following reasons

- 1] Available in large sizes for which least jointing required.
- 2] More stable to atmospheric changes as compared to timber.
- 3] Surfaces are plane and no jack-planing or machining needed.
- 4] Pasting of veneers or laminates is easier and more durable.
- 5] Stronger than the solid wood as it has same strength in all directions.
- 6] The thinner sheets are flexible.
- 7] Storing, stacking and transporting is easier.

Acoustic materials: -

- When the sound intensity is more, then it gives the great trouble or nuisance to the particular area like auditorium, cinema hall, studio, recreation center, entertainment hall, college reading hall. Hence it is very important to make that area or room to be sound proof by using a suitable material called as 'Acoustic material'.
- acoustics treatment is provided so as to control the outside as well as inside sound of the various building until such that sound will be audible without any nuisance or disturbance.

Types of acoustic materials; -

- Acoustic plaster.
- Acoustic tiles.

- Perforated plywood.
- Fibrous plaster.
- Straw board.
- Pulp board.
- Compressed fiber board.
- Hair felt.
- Cork board slabs.
- Foam glass.
- Asbestos cement boards.
- Thermocoal.
- Foam plastic.
- Chip boards.
- Gasket cork sheet.

Properties of acoustic materials: -

- Sound energy is captured and adsorbed.
- It has a low reflection and high absorption of sound.
- Higher density improves the sound absorption efficiency at lower frequencies.
- It controls the sound and noise levels from machinery and other sources for environmental amelioration and regulatory compliance.
- Acoustic material reduces the energy of sound waves as they pass through.
- It suppresses echoes, reverberation, resonance and reflection.

Uses of acoustic materials; -

Acoustic material plays a vital role in the various area of building construction. In studio, class room, reading hall, cinema theatre etc.

Artificial sand: -

It is obtained as a by-product while crushing stones to get coarse aggregates/chips.

Wall cladding: -

It refers to external layer of building which provides aesthetic effect along with protects the building structure from weathering phenomena like rainfall. It may be of stone cladding, vinyl cladding or aluminium cladding etc.

Micro-silica: -

- Micro silica, also known as silica fume or condensed silica fume is a mineral admixture composed of very fine solid glassy spheres of silicon dioxide.
- It is usually found as a by-product in the industrial manufacture of ferrosilicon and metallic silicon in high-temperature electric arc furnaces.
- These are used to improve strength and durability of concrete.

Ch. 2 PREFABRICATOIN

Concept of prefabrication: -

- Prefabrication is the method of construction which includes assembling components of a structure in a manufacturing or production site other than the actual site and then transporting complete assemblies or partial assemblies to the actual site where the structure is to be located.
- It is combination of good design with modern high-performance components and quality-controlled manufacturing procedures.
- This work is carried out in two stages, manufacturing of components in a place other than final location and their erection in position.
- Prefabricated sections are produced in large quantities in a factory and then shipped to various construction sites.
- This procedure may allow work to continue despite poor weather conditions and should reduce any waste in time and material at the site.
- Precast concrete units are cast and hardened before being used for construction. Sometimes builders cast components at the building site and hoist them into place after they harden. This technique permits the speedy erection of structures.
- For ex: - The conventional method of building a house is to transport bricks, timber, cement, sand, steel and construction aggregate, etc. to the site, and to construct the house on site from these materials. In prefabricated construction, only the foundations are constructed in this way, while sections of walls, floors and roof are prefabricated (assembled) in a factory (possibly with window and door frames included), transported to the site, lifted into place by a crane and bolted together.
- Prefabrication avoids the need to transport so many skilled workers to the construction site, and other restricting conditions such as a lack of power, lack of water, exposure to harsh weather or a hazardous environment are avoided.

Stages of prefabrication: -

The Prefabrication as defined will be done in two stages

1. Manufacturing at factory condition and erection of
2. components at the required location.

Casting: – Precast components are casted with controlled cement concrete in moulds of required shape and sizes. Reinforcement is placed before Pouring any concrete. The vibrator is used to vibrate concrete and this removes any honeycombing inside the components. This removes any honeycombing inside the components.

Curing: – After 24 hours of casting, the casted components are released from the mould and transported to curing tanks. Certain special components like railway sleepers where high strength is required are steam cured. Curing will be done for at least 3 days and further it will be cured after erecting these components at the site.

Transportation and erection: – After complete curing is done the components are transported to the site with heavy trucks and erection will be done using cranes with skilled labour force.

Prefabricated building components: -

Columns: -

- Column is a vertical member carrying the beam and floor loadings to the foundation
- It is a compression member and therefore the column connection is required to be proper and this can be done by ensuring continuity.

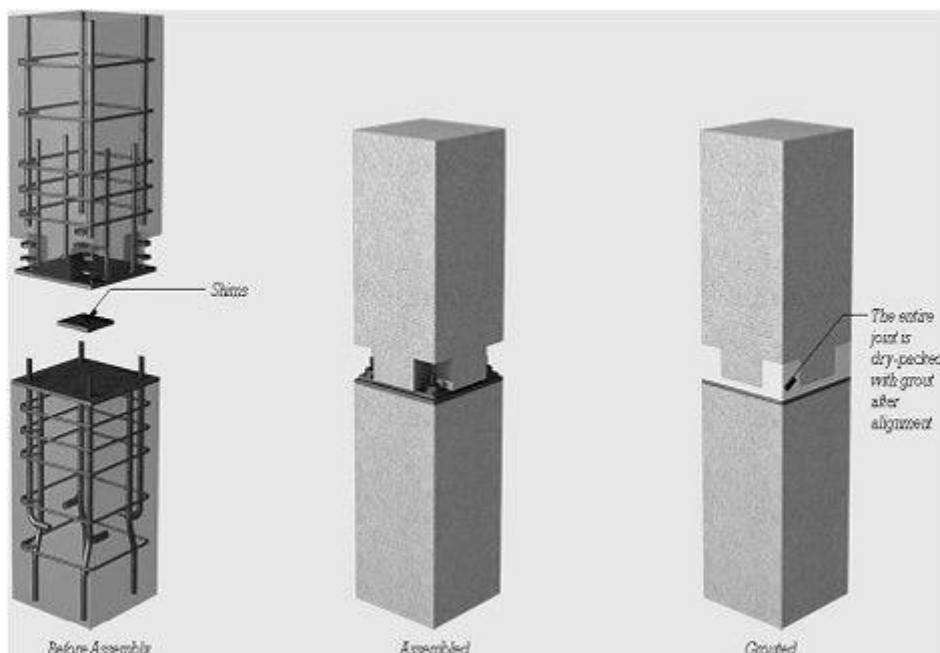

Beams: -

- Beams can vary in their complexity of design and reinforcement from the very simple beam formed over an isolated opening to the more common encountered in frames where the beams transfer their loadings to the column. Methods of connecting beams and columns are: -
 - A precasting concrete haunch is cast on to the column with a locating dowel or stud bolt to fix the beam.

- A projecting metal corbel is fixed to the column and the beam is bolted to the corbel.
- Column and beam reinforcement, generally in the form of hooks, are left exposed. The two members are hooked together and covered with insitu concrete to complete the joint. This is as shown in the figure.

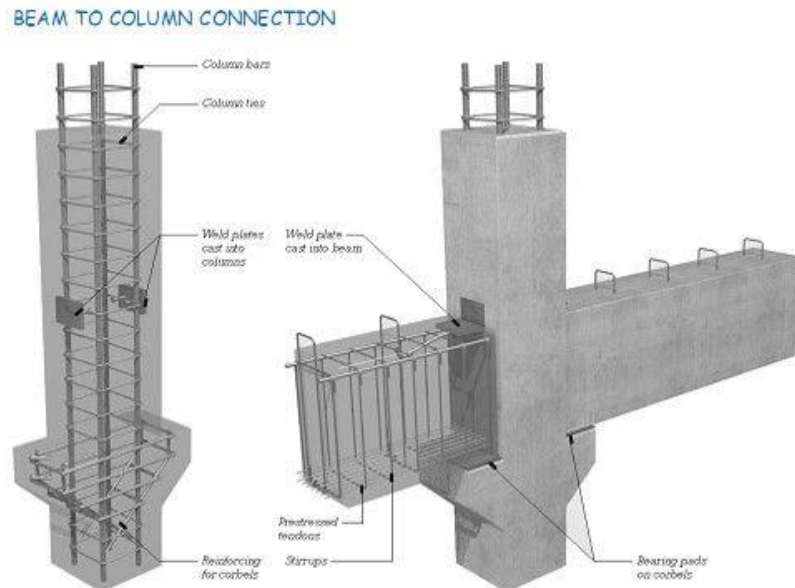

Slabs: -

- **Waffle unit for flooring / roofing:** – These are suitable for roofs / floors spanning in two directions. They are laid in a grid pattern. These units are cast in moulds. The saving achieved is not much. Also Shuttering are complicated and costly. Time consumption for construction is less.

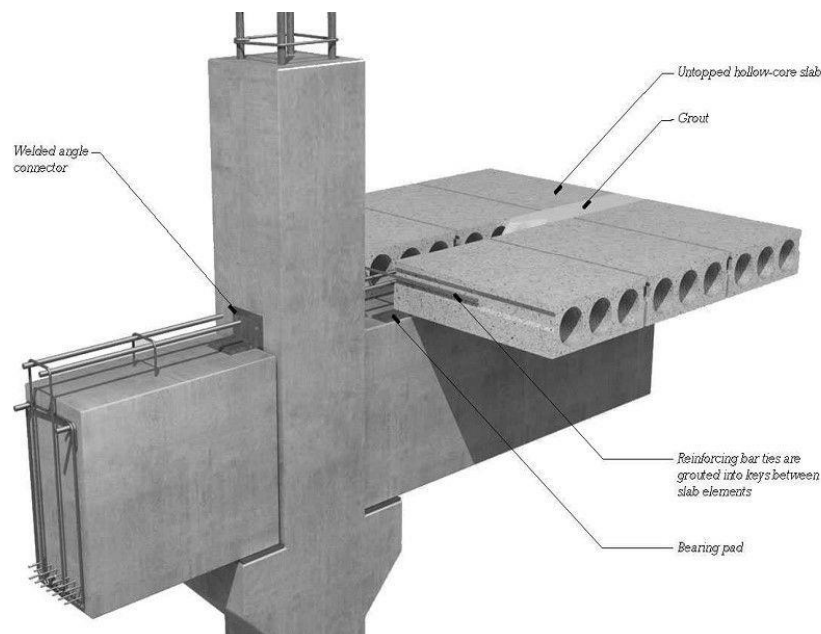

Advantages of prefabrication: -

- Saving in cost, material, time & manpower.
- Shuttering and scaffolding is not necessary.
- Installation of building finishes can be done immediately.
- Independent of weather condition.
- Components produced at close supervision. So quality is good
- Clean and dry work at site.
- Possibility of alterations and reuse
- Correct shape and dimensions and sharp edges are maintained.
- Very thin sections can be entirely precast with accuracy.

Disadvantages of prefabrication: -

- Handling and transportation may cause breakages of members so care has to be taken.
- It is a non-monolithic construction.
- Leaks can form at joints in prefabricated components.
- Placement of members plays a major role
- High transport cost and also Large prefabricated sections require heavy-duty cranes.
- Need of erection equipment.
- Skilled labour and supervision are required.

Ch. 3 EARTHQUAKE RESISTANT CONSTRUCTION

- Earthquake is a natural phenomenon occurring with all uncertainties. Among all the natural calamities, the most devastating one is earthquake.
- During the earthquake, ground motions occur in a random fashion, both horizontally and vertically, in all directions radiating from epicentre.
- Hence structures in such locations need to be suitably designed and detailed to ensure stability, strength and serviceability with acceptable levels of safety under seismic effects.

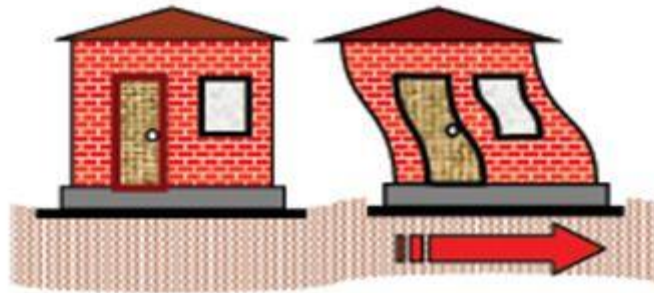

The principle of earthquake-resistant design of building has two aims:

1. The building shall withstand with almost no damage to moderate earthquake which have probability of occurring several times during life of a building.
2. The building shall not collapse or harm human lives during severe earthquake motions which have a probability of occurring less than once during the life of the building.

In order to satisfy these aims, building design should conform following rules:

- (a) The configuration of the building (Plan and elevation) should be as simple as possible.
- (b) The formation should generally be based on hard and uniform ground.
- (c) The members resisting horizontal forces should be arranged so that torsional deformation is not produced.
- (d) The structure of the building should be dynamically simple and definite.
- (e) The frame of the building structure should have adequate ductility in addition to required strength.
- (f) Deformations produced in a building should be held to values, which will not provide obstacles to safety use of building.

Classification of earthquake: -

Intensity of an earthquake is measured by an instrument called Richter Scale. Classifications of earthquakes are as follows:

Slight: Magnitude up to 4.9 on the Richter Scale

Moderate: Magnitude 5.0 to 6.9

Great: Magnitude 7.0 to 7.9

Very Great: Magnitude 8.0 and above

- India is divided into 4 seismic zones

Building configuration: -

1. The building should have a simple rectangular plan and be symmetrical both with respect to mass and rigidity so that the centres of mass and rigidity (centre of mass is the point at which whole mass of an object is assumed to be concentrated while centre of rigidity is the point at which if a lateral force acts it won't cause torsion rather translation only) of the building coincide with each other in which case no separation sections other than expansion joints are necessary.

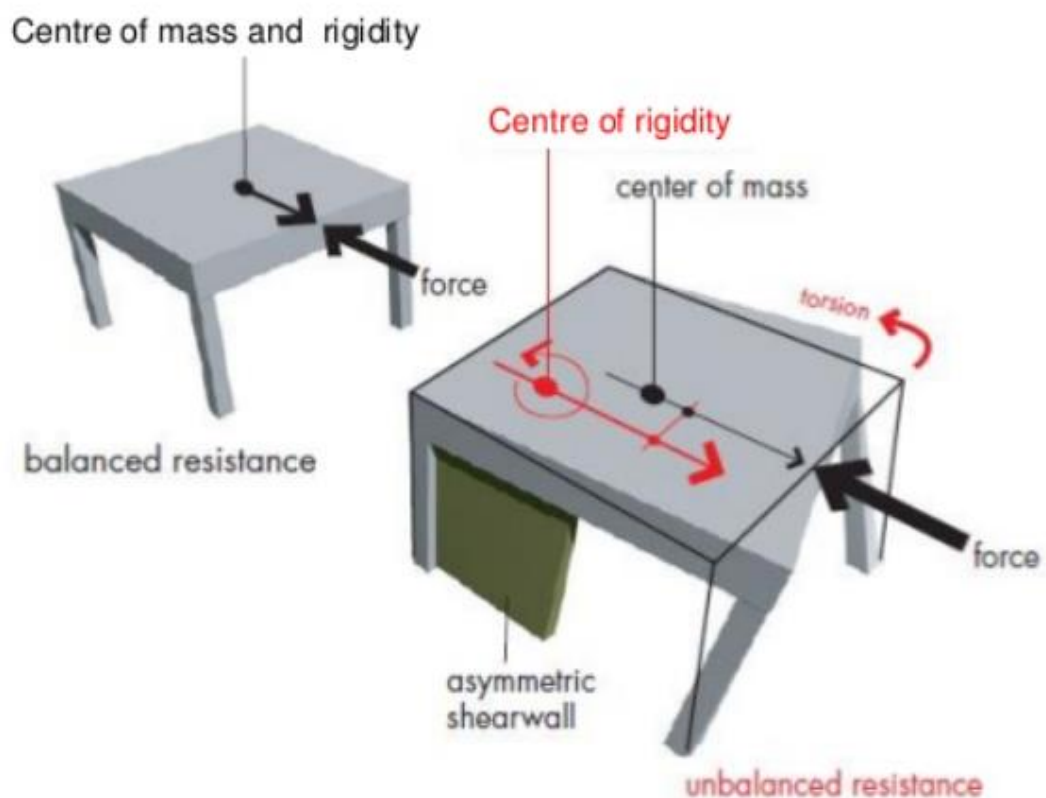

2. If symmetry of the structure is not possible in plan, elevation or mass, provision shall be made for torsional and other effects due to earthquake forces in the structural design or the parts of different rigidities may be separated through crumple sections. The length of such building between separation sections shall not preferably exceed three times the width.

3. Buildings having plans with shapes like, L, T, E and Y shall preferably be separated into rectangular parts by providing separation sections at appropriate places. Typical examples are shown in Fig. 1.

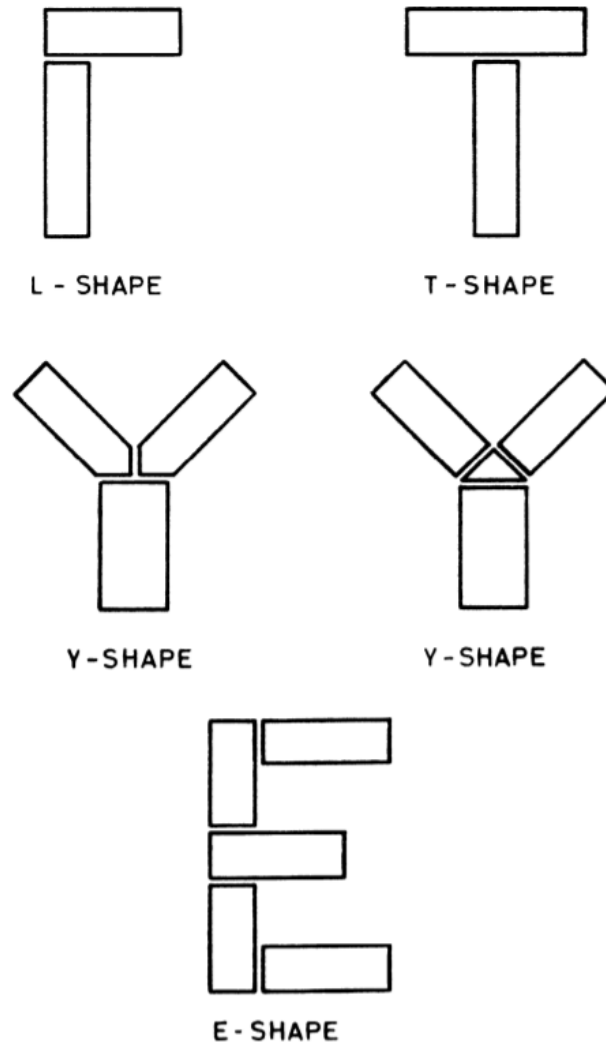

FIG. 1 TYPICAL SHAPES OF BUILDING WITH SEPARATION SECTIONS

Building characteristics: -

- Since the earthquake force is a function of mass, the building shall be as light as possible consistent with structural safety and functional requirements. Roofs and upper storeys of buildings, in particular, should be designed as light as possible.
- As far as possible, the parts of the building should be tied together in such a manner that the building acts as one unit.
- For parts of buildings between separation or crumple sections or expansion joints, floor slabs shall be continuous throughout as far as possible.

Concrete slabs shall be rigidly connected or integrally cast with the support beams.

- Additions and alterations to the structures shall be accompanied by the provision of separation or crumple sections between the new and the existing structures as far as possible, unless positive measures are taken to establish continuity between the existing and the new construction.
- Projecting parts shall be avoided as far as possible. If the projecting parts cannot be avoided, they shall be properly reinforced and firmly tied to the main structure.
- Ceiling plaster shall preferably be avoided. When it is unavoidable, the plaster shall be as thin as possible.
- Suspended ceiling shall be avoided as far as possible. Where provided they shall be light, adequately framed and secured.
- The structure shall be designed to have adequate strength against earthquake effects along both the horizontal axes.
- The structure shall not be founded on such loose soils which will subside or liquefy during an earthquake, resulting in large differential settlements.
- The main structural elements and their connection shall be designed to have a ductile failure. This will enable the structure to absorb energy during earthquakes to avoid sudden collapse of the structure. Providing reinforcing steel in masonry at critical sections, as provided in this standard will not only increase strength and stability but also ductility.
- Suitable details shall be worked out to connect the non-structural parts with the structural framing so that the deformation of the structural frame leads to minimum damage of the non-structural elements.
- Fire frequently follows an earthquake and therefore, buildings shall be constructed to make them fire resistant.

Lateral load resisting structures: -

- Moment resisting frames
 - Ordinary moment resisting frames (OMRF)
 - Special moment resisting frames (SMRF)
- Cross-braced frames
- Structural or shear walls

Moment resisting frames: -

It is a frame in which members and joints are capable of resisting forces primarily by flexure. OMRF is a moment-resisting frame not meeting special detailing requirements for ductile behaviour. SMRF is a moment-resisting frame specially detailed to provide ductile behaviour.

Shear walls: -

A wall designed to resist lateral force in its own plane. Braced frames, subjected primarily to axial stresses, shall be considered as shear walls for the purpose of this definition.

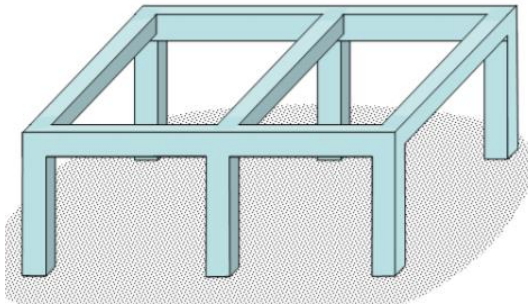

Moment resisting frames

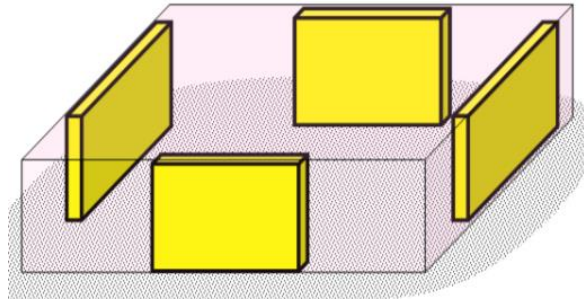

structural or shear walls

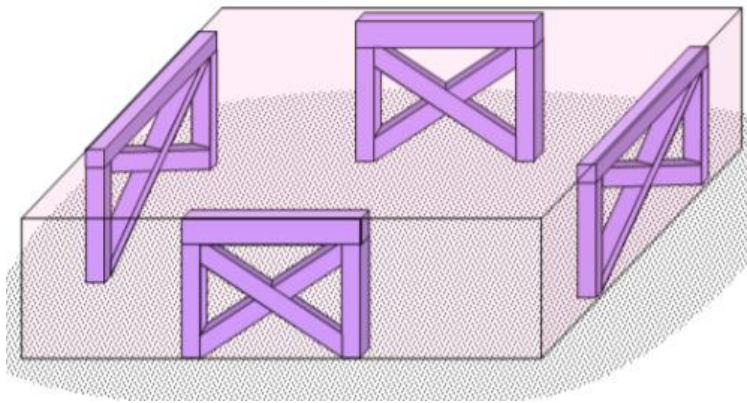

Cross-braced frames

Bands: -

- A reinforced concrete or reinforced brick runner provided in the walls to tie them together and to impart horizontal bending strength in them.
- Horizontal bands are the most important earthquake-resistant feature in masonry buildings. The bands are provided to hold a masonry building as a single unit by tying all the walls together. There are four types in a typical masonry building named after their locations in the building. They are:

(a) Plinth band: This should be provided in those cases where the soil is soft or uneven in their properties, as it usually happens in hilly areas. This band is not too critical.

(b) Lintel band: This is the most important band and covers all door and window lintel.

(c) Roof band: In buildings with flat reinforced concrete or reinforced brick roofs, the roof band is not required because the roof slab itself plays the role of a band. However, in buildings with flat timber or CGI sheet roof, a roof band needs

to be provided. In buildings with pitched or sloped roof, the roof band is very important. It is a band provided immediately below the roof or floors.

(d) Gable band: It is employed only in buildings with pitched or sloped roofs. It is a band provided at the top of gable masonry below the purlins.

- The band shall be made of reinforced concrete of grade not leaner than M15 or reinforced brick-work in cement mortar not leaner than 1 : 3. The bands shall be of the full width of the wall, not less than 75 mm in depth and reinforced with steel.

BANDS

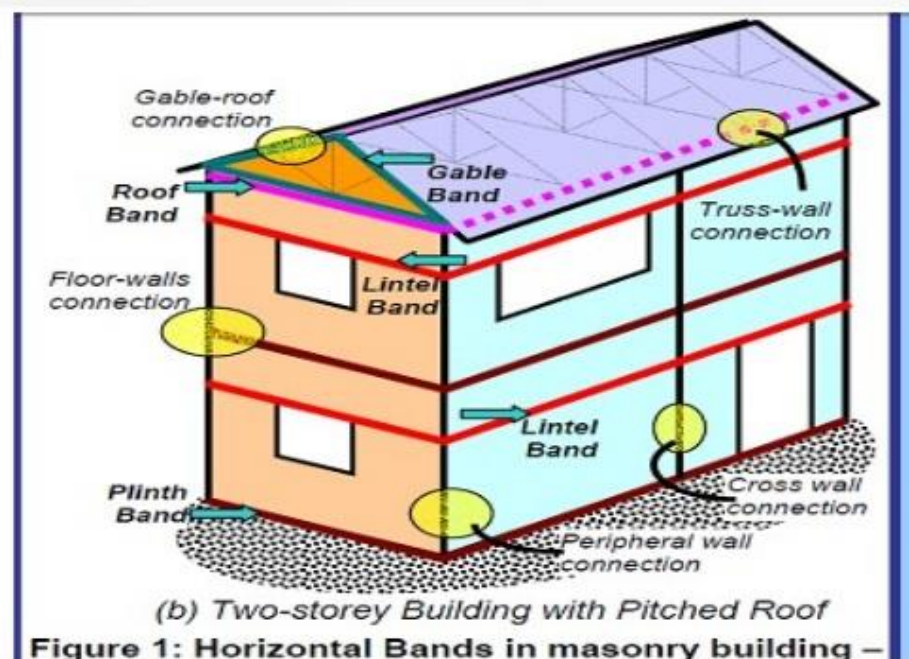

The irregularity in building structures may be due to irregular distribution in their mass, strength and stiffness along the height of building. There are broadly two types of irregularities: -

1. Plan irregularities
2. Vertical irregularities

Plan Irregularities (Fig. 3)

(Clause 7.1)

Sl No.	Irregularity Type and Description
(1)	(2)
i)	<i>Torsion Irregularity</i> To be considered when floor diaphragms are rigid in their own plan in relation to the vertical structural elements that resist the lateral forces. Torsional irregularity to be considered to exist when the maximum storey drift, computed with design eccentricity, at one end of the structures transverse to an axis is more than 1.2 times the average of the storey drifts at the two ends of the structure
ii)	<i>Re-entrant Corners</i> Plan configurations of a structure and its lateral force resisting system contain re-entrant corners, where both projections of the structure beyond the re-entrant corner are greater than 15 percent of its plan dimension in the given direction
iii)	<i>Diaphragm Discontinuity</i> Diaphragms with abrupt discontinuities or variations in stiffness, including those having cut-out or open areas greater than 50 percent of the gross enclosed diaphragm area, or changes in effective diaphragm stiffness of more than 50 percent from one storey to the next
iv)	<i>Out-of-Plane Offsets</i> Discontinuities in a lateral force resistance path, such as out-of-plane offsets of vertical elements
v)	<i>Non-parallel Systems</i> The vertical elements resisting the lateral force are not parallel to or symmetric about the major orthogonal axes or the lateral force resisting elements

Vertical Irregularities (Fig. 4)

(Clause 7.1)

Sl No.	Irregularity Type and Description
(1)	(2)
i)	<p>a) <i>Stiffness Irregularity — Soft Storey</i> A soft storey is one in which the lateral stiffness is less than 70 percent of that in the storey above or less than 80 percent of the average lateral stiffness of the three storeys above</p> <p>b) <i>Stiffness Irregularity — Extreme Soft Storey</i> A extreme soft storey is one in which the lateral stiffness is less than 60 percent of that in the storey above or less than 70 percent of the average stiffness of the three storeys above. For example, buildings on STILTS will fall under this category.</p>
ii)	<p><i>Mass Irregularity</i> Mass irregularity shall be considered to exist where the seismic weight of any storey is more than 200 percent of that of its adjacent storeys. The irregularity need not be considered in case of roofs</p>
iii)	<p><i>Vertical Geometric Irregularity</i> Vertical geometric irregularity shall be considered to exist where the horizontal dimension of the lateral force resisting system in any storey is more than 150 percent of that in its adjacent storey</p>
iv)	<p><i>In-Plane Discontinuity in Vertical Elements Resisting Lateral Force</i> A in-plane offset of the lateral force resisting elements greater than the length of those elements</p>
v)	<p><i>Discontinuity in Capacity — Weak Storey</i> A weak storey is one in which the storey lateral strength is less than 80 percent of that in the storey above. The storey lateral strength is the total strength of all seismic force resisting elements sharing the storey shear in the considered direction.</p>

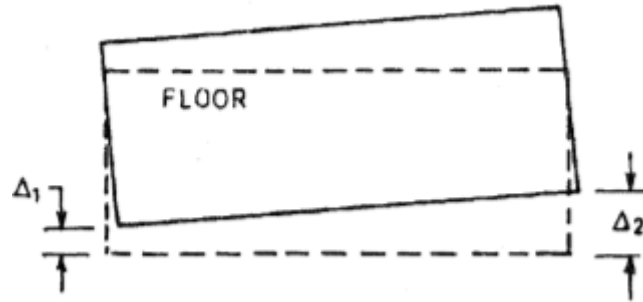

(Torsional irregularity)

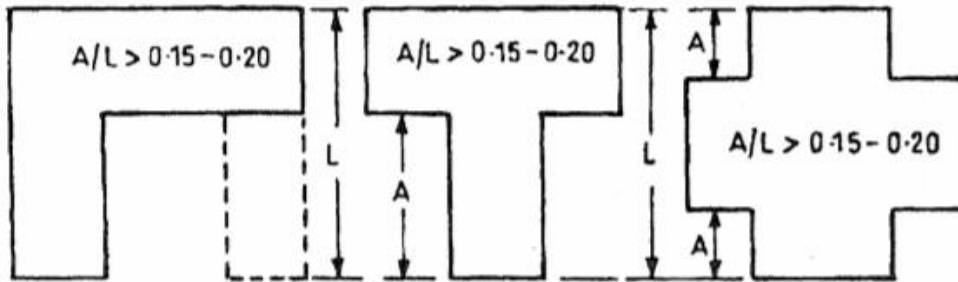

(Re-entrant corner)

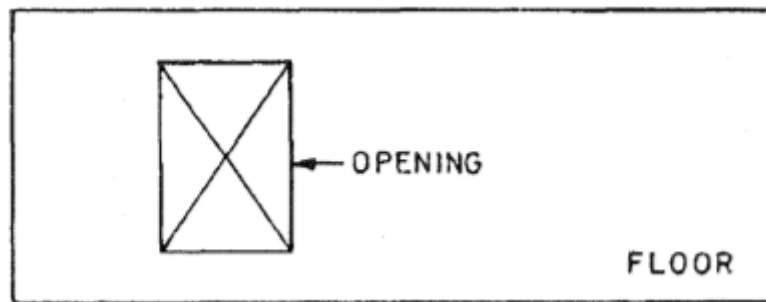

(Diaphragm discontinuity)

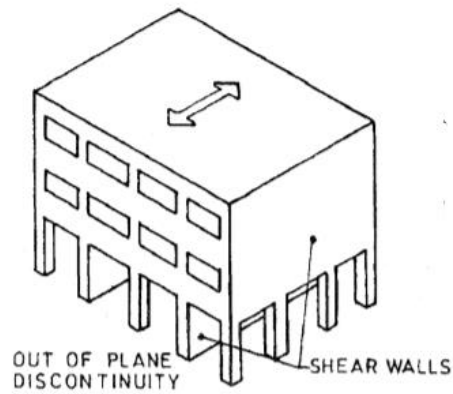

(Out of plane offsets)

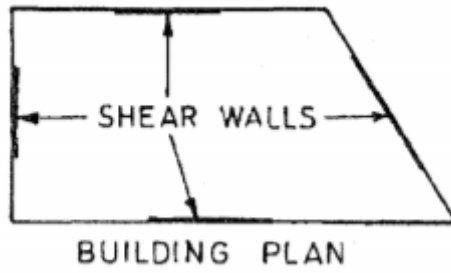

(Non-parallel system)

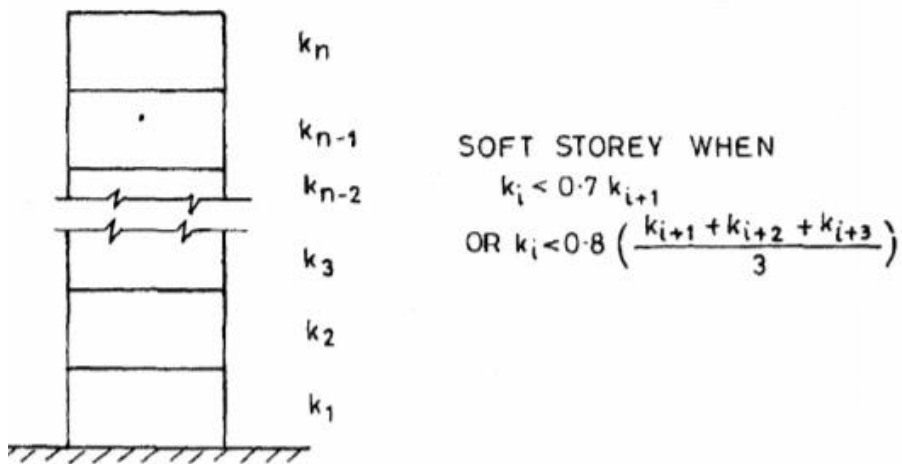

(Stiffness irregularity)

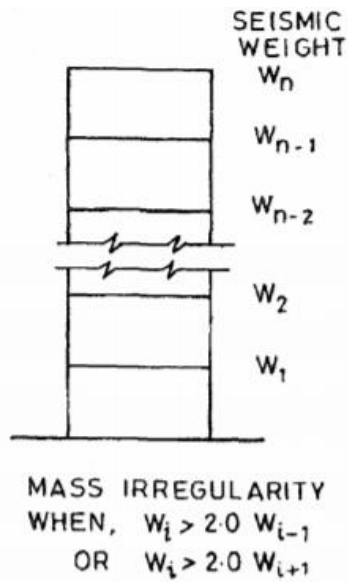

(Mass irregularity)

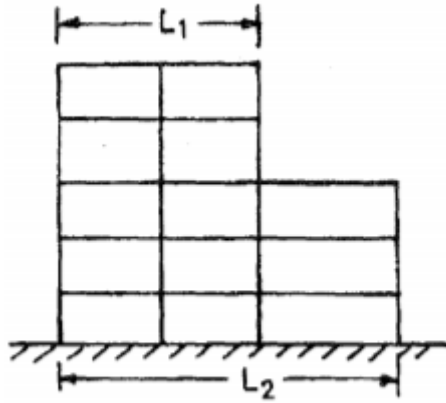

(Vertical geometric irregularity)

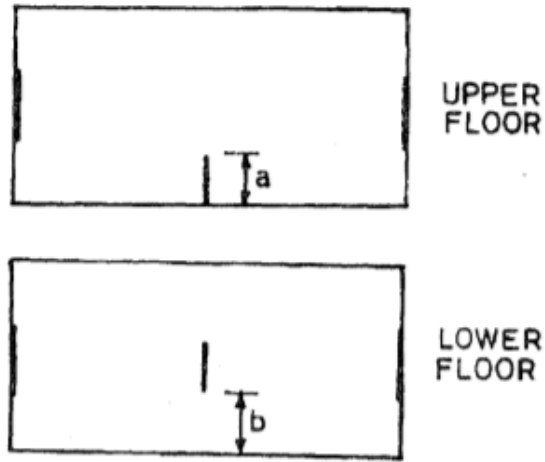

(In-plane discontinuity)

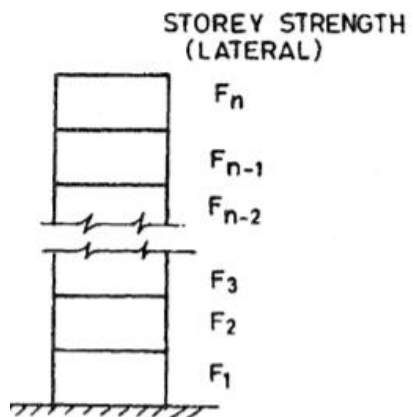

4 E Weak Storey when $F_i < 0.8 F_{i+1}$

(Discontinuity in capacity)

Additions to existing structure: -

Additions shall be made to existing structures only as follows:

- a) An addition that is structurally independent from an existing structures shall be designed and constructed in accordance with the seismic requirements for new structures.
- b) An addition that is not structurally independent from an existing structure shall be designed and constructed such that the entire structure conforms to the seismic force resistance requirements for new structures unless the following three conditions are complied with:
 - 1) The addition shall comply with the requirements for new structures,
 - 2) The addition shall not increase the seismic forces in any structural elements of the existing structure by more than 5 percent unless the capacity of the element subject to the increased force is still in compliance with this standard, and
 - 3) The addition shall not decrease the seismic resistance of any structural element of the existing structure unless reduced resistance is equal to or greater than that required for new structures.

Ch. 4 RETROFITTING OF STRUCTURES

Retrofitting is the process by which we add new features to existing structures, such as heritage sites, older buildings, and bridges, etc. Retrofitting helps in reducing the vulnerability of damage to an existing structure in case of any natural disaster or seismic activity.

Seismic retrofitting of concrete structures:-

It is the modification of existing structures to make them more resistant to seismic activity, ground motion, or soil failure due to earthquakes. The retrofit techniques are also applicable for other natural hazards such as tropical cyclones, tornadoes, and severe winds from thunderstorms.

Need/importance of retrofitting: -

- To ensure the safety and security of a building, employees, structure functionality, machinery and inventory
- Essential to reduce hazard and losses from non-structural elements.
- predominantly concerned with structural improvement to reduce seismic hazard.
- Important buildings must be strengthened whose services are assumed to be essential just after an earthquake like hospitals.

Basic concept of retrofitting: -

Retrofitting aims at,

- Up gradation of lateral strength of the structure
- Increase in the ductility of the structure
- Increase in strength and ductility

Source of weakness of RC framed buildings:-

Mainly, there are 3 sources of weakness of RC framed buildings they are

- a) Discontinuous load path/ interrupted load path/irregular load path
- b) Lack of deformation compatibility of structural members
- c) Quality of workmanship and poor quality of material

a) Structural Damage due to Discontinuous Load path

Every structure must have two load resisting systems, (a) vertical load resisting system for transferring the vertical load to ground (b) horizontal load resisting system for transferring the horizontal load to vertical load system. It is imperative that the seismic forces should be properly collected by the horizontal framing

system and properly transferred into vertical lateral resisting system. Any discontinuity/irregularity in this load path or load transfer may cause one of the major contributions to structural damage during strong earthquakes. In addition it must be ensured that each member both of horizontal or vertical load resisting system must be strong enough and not fail during an earthquake. Therefore, all the structural and non-structural elements must have sufficient strength and ductility and should be well connected to the structural system so that the load path must be complete and sufficiently strong.

b) Structural Damage due to Lack of Deformation

The main problems in the structural members of moment resisting frame building are the limited amount of ductility and the inability to redistribute load in order to safely withstand the deformations imposed upon in response to seismic loads. The most common regions of failure in an existing reinforced concrete frame may be in columns, beams, walls and beam-column joints. It is important to consider the consequences of member failure or structural performance. Inadequate strength and ductility of the structural member can and will result in local or complete failure of the system.

c) Quality of Workmanship and Materials

There are numerous instances where faulty construction practices and lack of quality control have contributed to the damage. The faulty construction practices may be like, lack of amount and detailing of reinforcement as per requirement of code particularly when the end of lateral reinforcement is not bent by 135 degrees as the code specified. Many buildings have been damaged due to poor quality control of design material strength as specified, spelling of concrete by the corrosion of embedded reinforcing bars, porous concrete, age of concrete, proper maintenance etc.

Classification of retrofitting techniques: -

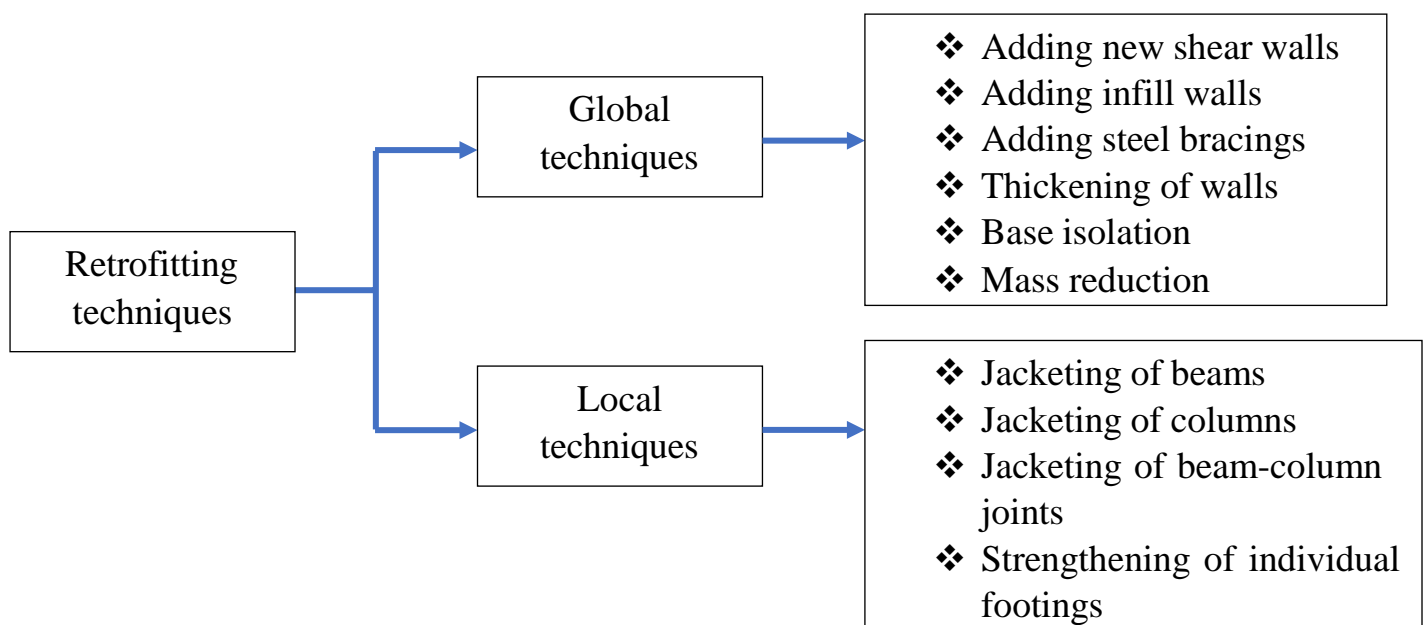

Adding new shear walls: -

- ❖ These are frequently used for retrofitting of non ductile reinforced concrete frame buildings.
- ❖ The added elements can be either cast-in-place or precast concrete elements.
- ❖ New elements preferably be placed at the exterior of the building.
- ❖ Not preferred in the interior of the structure to avoid interior mouldings.

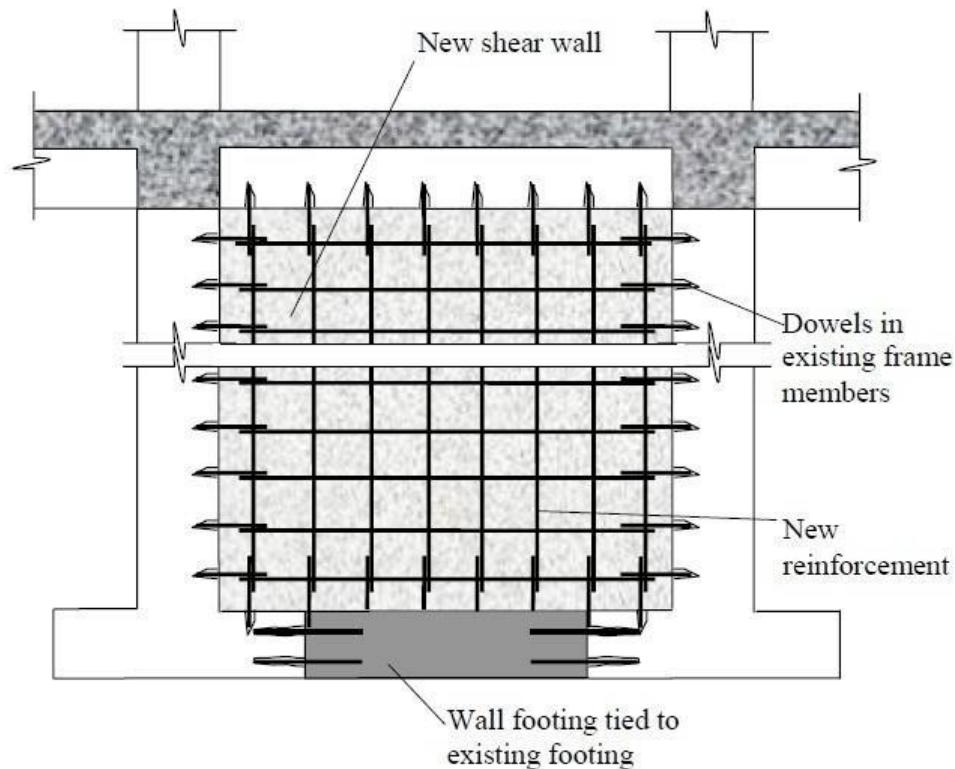

Adding infill walls: -

- Adding infill walls increases the stiffness and reduces the fundamental period of the structure by up to 20%, indicating the effect of the infill on the structural stiffness.
- These walls are enclosed in steel and concrete frames and can withstand part of the earthquake force at the time of the earthquake due to strength and stiffness.
- This method is mostly used in short steel buildings. Depending on the materials used, the infill's can be made of brick, concrete, etc.

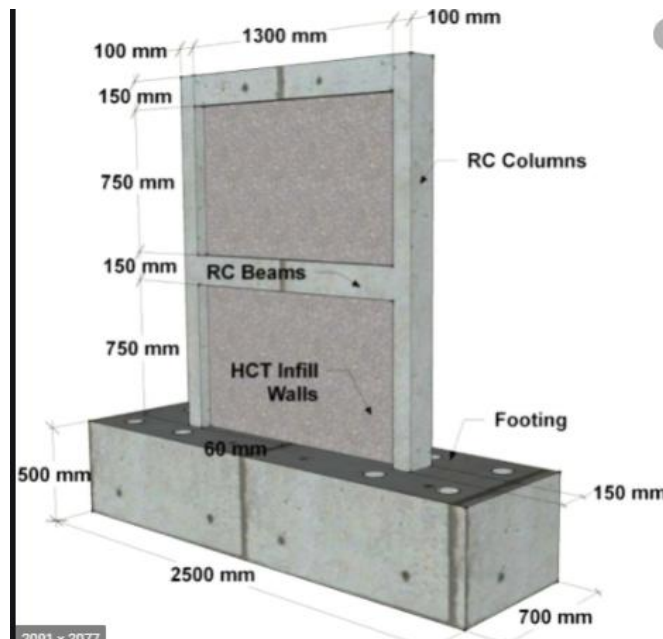

Adding steel bracings: -

- This technique is an effective solution when large openings are required.
- Potential advantages due to higher strength and stiffness, opening for natural light can be provided, amount of work is less since foundation cost may be minimized and adds much less weight to the existing structure.

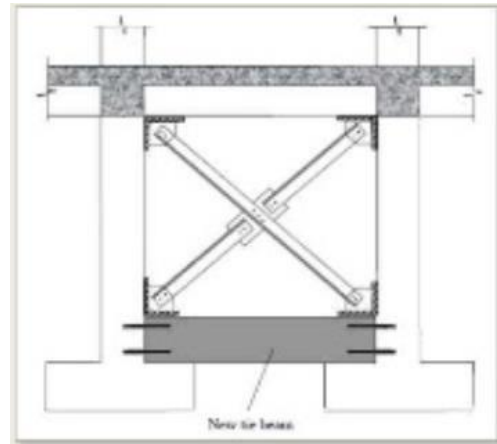
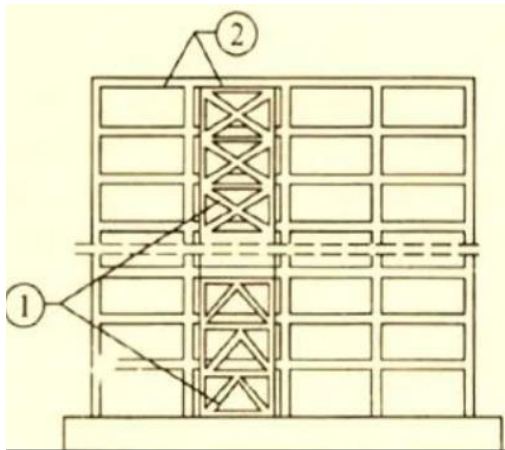

1 – existing structure

2- steel bracing added

Base isolation: -

Isolation of superstructure from the foundation is known as base isolation. It is the most powerful tool for passive structural vibration control techniques.

- ❖ Isolates Building from ground motion – Lesser seismic loads, hence lesser damage to the structure, -Minimal repair of superstructure.
- ❖ Building can remain serviceable throughout construction.
- ❖ Does not involve major intrusion upon existing superstructure

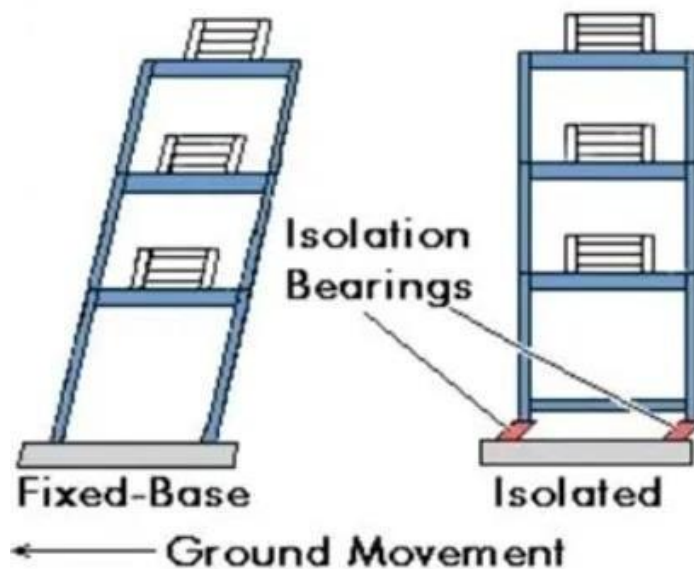

Mass reduction techniques: -

This may be achieved, for instance, by removal of one or more storey's as shown in Figure. In this case it is evident that the removal of the mass will lead to a decrease in the period, which will lead to an increase in the required strength.

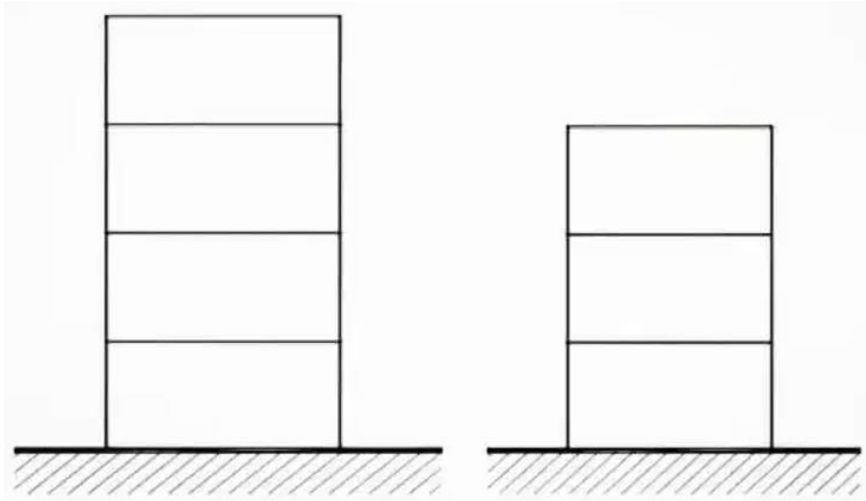

Wall thickening: -

The existing walls of a building are added to certain thickness by adding bricks, concrete and steel aligned at certain places as reinforcement, such that the weight of wall increases and it can bear more vertical and horizontal loads, and also it's designed under special conditions that the transverse loads does not cause sudden failure of the wall.

Jacketing: -

- ❖ A local retrofitting technique

There are 3 types of jacketing mainly,

- ❖ Steel jacket
- ❖ Reinforced concrete jacket
- ❖ Fibre reinforced polymer composite jacket

Jacketing is provided,

- ❖ To increase concrete confinement
- ❖ To increase shear strength
- ❖ To increase flexural strength

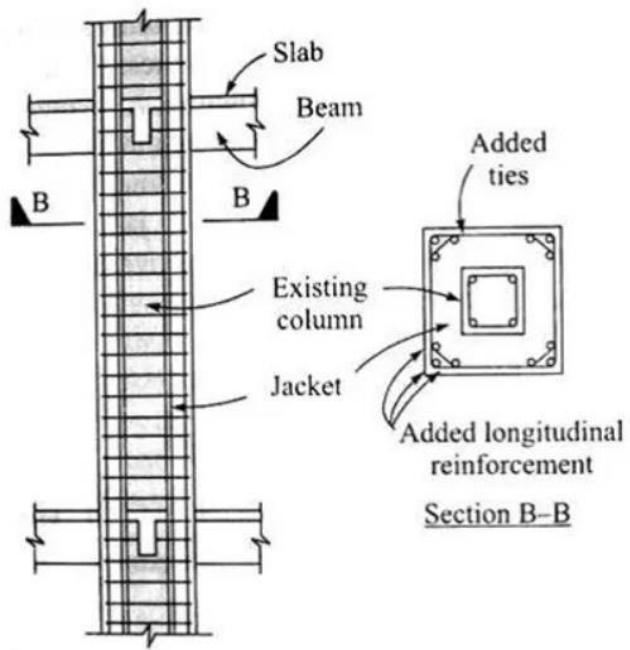

(Column jacking)

BUILDING SERVICES

5.1 COLD WATER DISTRIBUTION IN HIGH RISE BUILDING, LAY OUT OF INSTALLATION: -

There are three ways of cold water distribution in a building, they are

- By normal water pressure
- By overhead feed system
- By air pressure system

By normal water pressure: -

In this method only the normal water pressure is used to supply the cold water to various floors. Normally, the water pressure available is not much adequate to serve the buildings. Hence, the alternative solutions are by overhead feed system and by using compressed air pressure distribution system.

By overhead feed system: -

In this method, water is pumped into a large tank on top of building and is distributed to the fixtures by means of gravity.

Advantages: -

- water supply not affected by peak time hour
- water supply not affected by power interruption
- Replacement of parts will not affect the regular supply of water.

Disadvantages: -

- water is s.t contamination
- needs high maintenance cost
- occupies much space
- Requires stronger foundation and other structures to carry additional load of tank and water.

BUILDING SERVICES

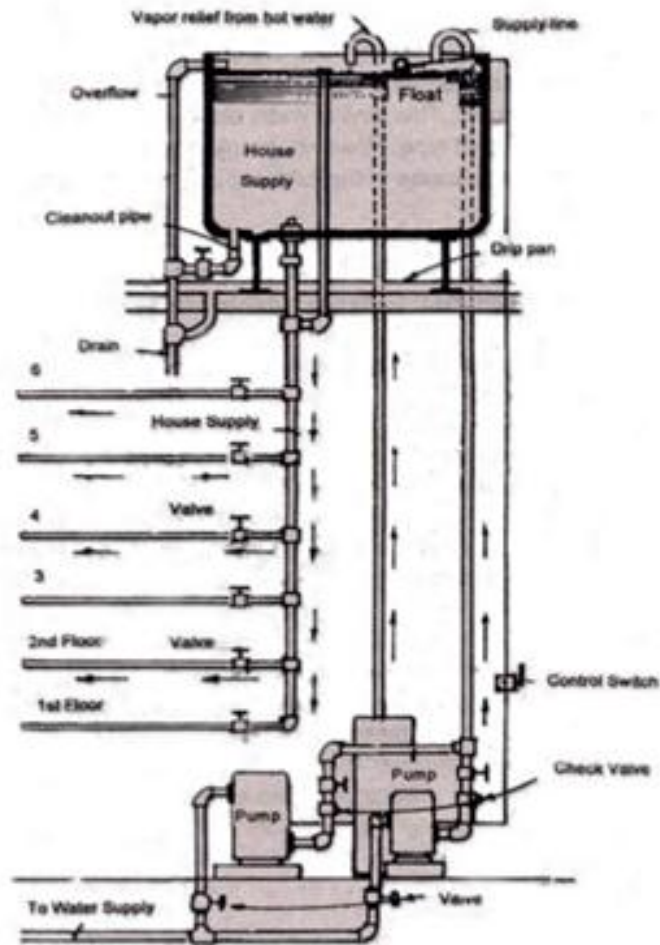

By air pressure system: -

In this method of water supply, compressed air is used to raise and push water in to the system.

Advantages:-

- With compact pumping unit
- Sanitary due to tight water chamber
- Oxygen in the compressed air serves as purifying agent
- Economical as smaller pipe dia. required
- Less initial construction and maintenance cost

Disadvantages: -

- Water supply gets affected by loss of pressure inside the tank in case of power interruption.

BUILDING SERVICES

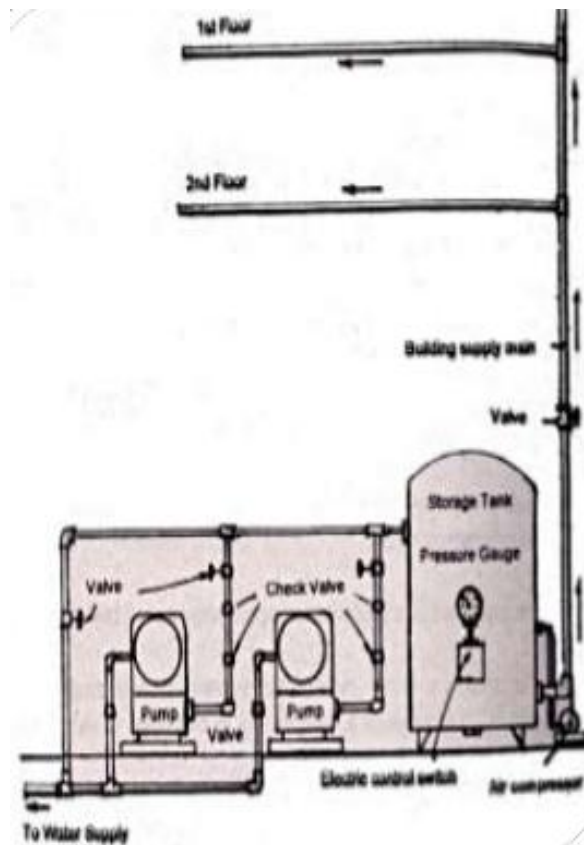

Assignment: what do you mean by valves? Why are they provided in pipelines? Explain the functions of different types of valves available with sketch.

5.2 HOT WATER SUPPLY – GENERAL PRINCIPLES FOR CENTRAL PLANTS-LAYOUT :-

There are basically two types of hot water supply systems, they are

- Upfeed system
- Downfeed system

Upfeed system: -

- This system requires a continuing network of pipes to provide constant circulation of water with sufficient pressure.
- Hot water rises on its own and does not need any pump for its circulation,
- Hot water can be immediately drawn from the fixtures at any time.
- Proves economical as unused circulating water returns back to main supply pipe.
- Predominantly used for medium rise buildings. (40-60 ft high)
- Pipe at the top of risers is usually large and size diminishes as it approaches to lower floors of building.

BUILDING SERVICES

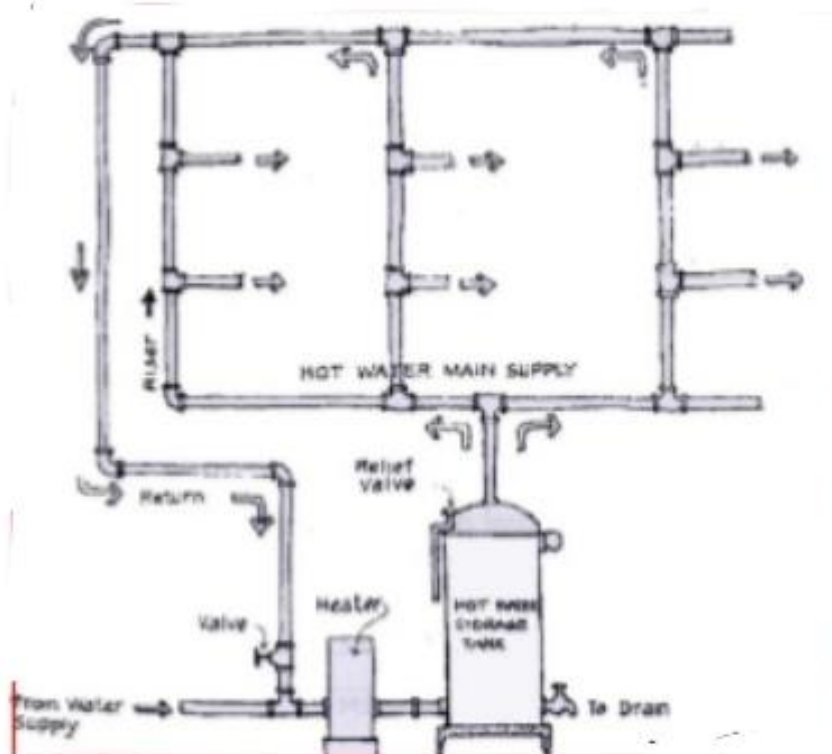

Downfeed system: -

- In this system, hot water rises on to the highest point of the plumbing system and travels to the fixtures by gravity (closed pipe system).
- In this, water distribution is dependent on the expansion of hot water and gravity
- Larger pipes are installed at bottom of riser and size diminishes as it approaches towards the upper floors of building.
- This system is more suitable for very tall buildings i.e. above 40-60 ft height.

Assignment: - write the advantages and disadvantages of upfeed and downfeed system of hot water supply.

BUILDING SERVICES

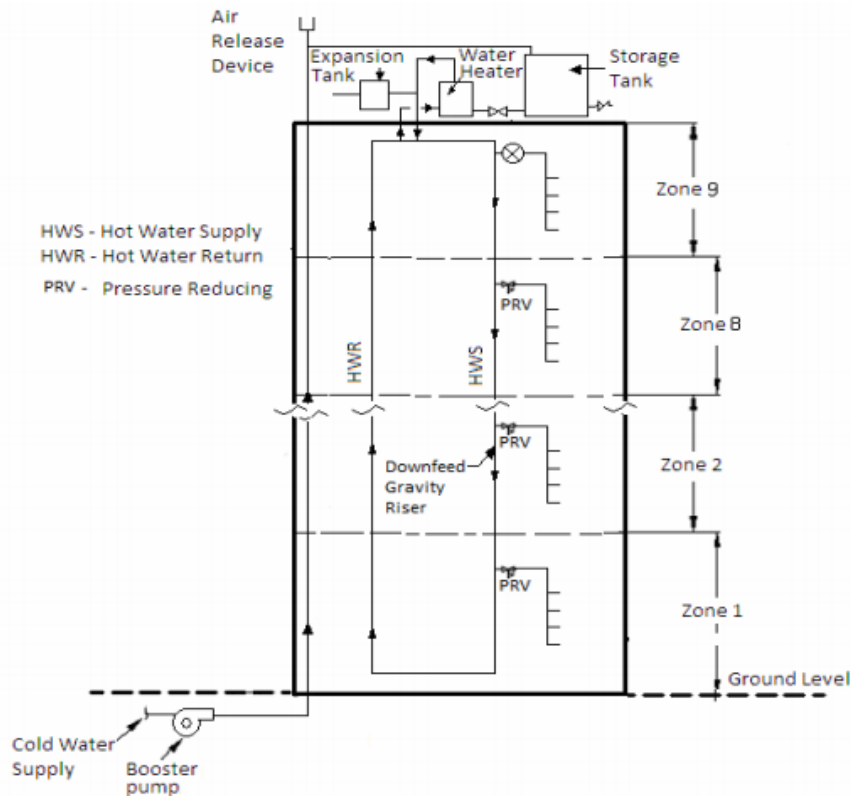

SANITATION IN BUILDINGS: -

- **Waste:** Waste can be defined as used up unwanted and discarded solid, liquid or gaseous substances generated from a community which can create hazardous impact to the environment.
- **Sewage:** Sewage can be defined as the used water or liquid waste generated by the community which includes human and household waste together with waste from the street washing, industrial purpose, institutional waste, ground water and storm water.

Constituents of waste water or sewage

- a) Domestic sewage
- b) Industrial waste
- c) Ground water or sub soil water entering into sewers
- d) Storm water or rain water
- e) Irrigation return water

It requires proper treatment before final disposal to the environment.

- **Sullage:** The liquid waste from kitchen, bathroom, wash basin are called sullage. Sullage can be carried in open drains and is not very foul smelling. So no treatment is needed before disposal. It does not include discharge from hospitals, operation theatres and slaughter house.

BUILDING SERVICES

- **Water Pipe:** A water pipe is any pipe or tube designed to transport treated drinking water to consumers. The varieties includes:
 - a) Large diameter main pipe which supply entire town
 - b) Smaller branch lines that supply a street or group of buildings
 - c) Small diameter pipe located within individual buildings

Materials commonly used to construct water pipes include- cast iron, polyvinyl chloride (PVC), copper, steel or concrete.

- **Soil Pipe:** The pipe which conveys the discharge of water closet or fixtures having similar functions with or without the discharge from other fixtures. The soil pipe also known as soil vent pipe. Soil pipes are vented high at the top or near to top of a building to allow gases produced by waste to vent safely into the atmosphere.
- **Waste pipe or Sullage pipe:** A waste pipe is often a similar diameter pipe that carries waste from sinks, washing machine, shower bath and any other appliance that uses water.
- **Vent Pipe:** A pipe in a sanitary pipe work system which helps in the circulation of air within the system and protects trap, seals from excessive pressure fluctuation.
- **Rain water pipe:** The pipe which carries rainwater from the roof and other part of a building to the building drain is called rain water pipe.
- **Sewer:** Sewer is a conduit or pipe usually circular laid below the ground level and generally slopping continuously towards the outfall. Sewers are generally designed to flow under gravity. Sewer can be divided into two categories.
 - a) **Sanitary sewer:** It is a system of underground pipes that carries waste from bathrooms, sinks, kitchen and other plumbing component to a wastewater treatment plant.
 - b) **Storm sewer:** It is designed to carry rainfall runoff and drainage. It is not designed to carry sewage.
- **Sewerage:** The entire system of conduits and appurtenances excluding for wastewater treatment is called 'sewerage system'.

There are four systems of waste water installations/ drainage plumbing. They are

- Two pipe system
- One pipe system
- Single stack system
- Partially ventilated single stack

Two pipe system:

In this system, two different sets of vertical pipes are installed. One for draining night soil (human excreta) and the other for draining sullage. The night soil carrying pipes

BUILDING SERVICES

are called Soil pipe and the pipes which carry sullage from bathrooms, kitchen etc. is called Sullage pipe or Waste pipe. The soil pipes as well as waste pipes are ventilated by providing separate vent pipes. This is best and most improved system of plumbing though it involves a large number of pipes and thus quite costly.



One pipe system:

Instead of two separate pipes, in this system only one main vertical pipe is provided, which collects the night soil as well as sullage water from their respective fixtures through branch pipes. The main pipe is ventilated by providing cowl at its top. In addition to this, a separate vent pipe is also provided. This system requires fewer pipes than two pipe system.

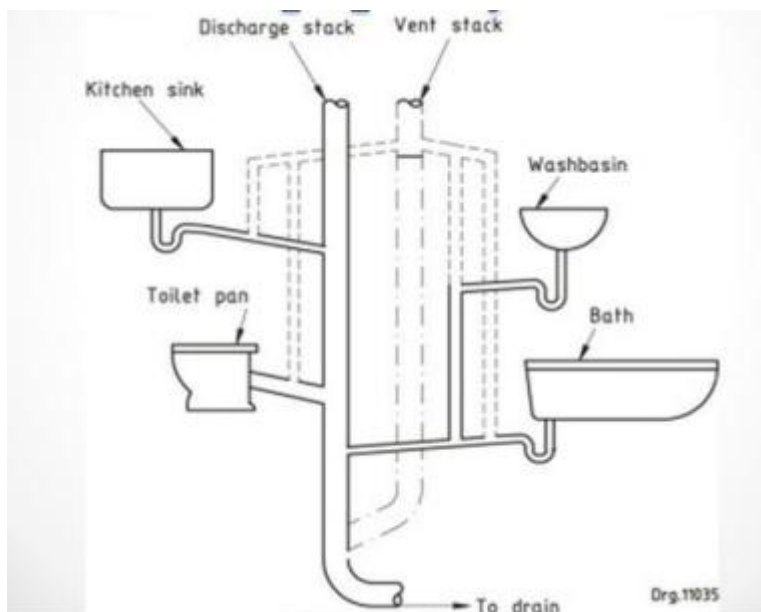

BUILDING SERVICES

Single stack system:

It is basically One pipe system, where the single pipe carries the sewage as well as the sullage. No separate vent pipe is provided here. Instead of providing separate vent pipe, the waste pipe is extended up to about 2m higher than the roof and provided with a cowl for removal of foul gases.

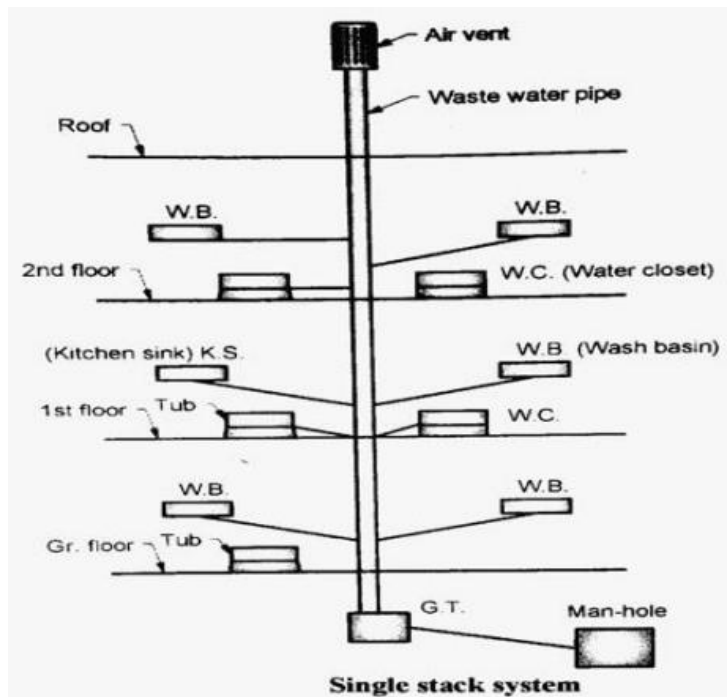

Partially ventilated single stack system:

This is an improved form of single stack system. In this system the traps of the water closets are separately ventilated by a separate vent pipe called relief vent pipe. The sullage fixtures are not connected to the vent pipe.

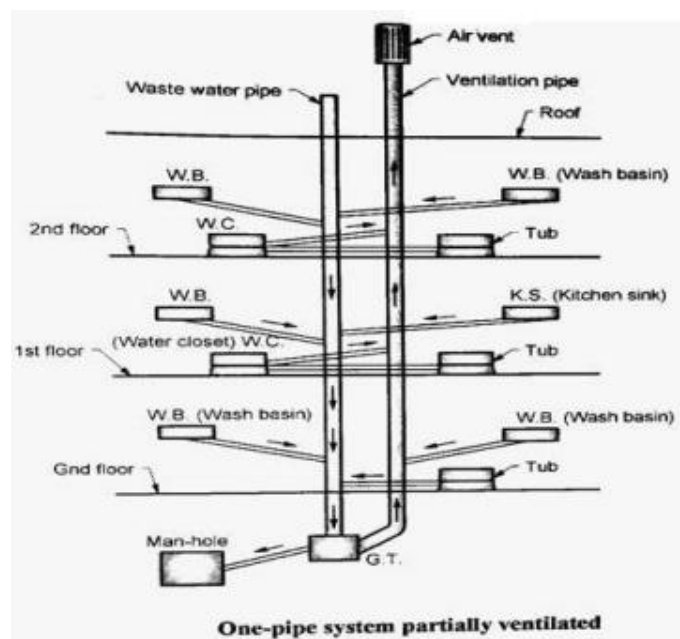

BUILDING SERVICES

LAYOUT AND TYPES OF ELECTRIC WIRING: -

Electrical wiring is an electrical installation of cabling and associated devices such as switches, distribution boards, sockets, and light fittings in a structure. Following are the types of electric wiring,

- Cleat Wiring
- Casing and Capping Wiring
- Batten Wiring (CTS or TRS)
- Conduit Wiring (Surface or Concealed)
- Lead Sheathed Wiring

Cleat wiring: -

In this, porcelain, wood or plastic cleats are fixed to walls or ceilings at regular intervals, i.e., 0.6 m between each cleat. PVC insulated cables are taken through the holes of each cleat and hence, the cleat supports and holds the wire.

This is an inexpensive method of wiring and is used for temporary installations. Therefore, it is not suitable for home electrical wiring and also it is an outdated method.

Casing and Capping Wiring: -

In this, cable is run through a wooden casing having grooves. The wood casing is prepared in such a way that it is of a required fixed length with parallel grooves that accommodates the cables. The wooden casing is fixed to the walls or ceiling with screws.

After placing the cables inside the grooves of casing, a wooden cap with grooves is placed on it to cover the cables. This is also a cheap wiring system, but there is a high risk of fire in case of short circuits.

Batten Wiring: -

In this, insulated wires are run through the straight teak wooden battens. The wooden battens are fixed on the ceilings or walls by plugs and screws. The cables are fitted onto the battens by using tinned brass link clips.

BUILDING SERVICES

These clips are fixed to the battens with rust-resistant nails. This wiring installation is simple and cheap as compared to other electrical wiring systems also takes less time to install. These are mainly used for indoor installations.

In this type of wiring, Cabtyre Sheathed Wire (CTS) or Tough Rubber Sheathed Wire (TRS) is generally used as the electrical conductor.

Conduit Wiring: -

In this wiring, PVC cables are taken through either PVC conduit pipes or through steel conduit pipes. This conduit wiring can be either surface conduit wiring or concealed conduit wiring.

If the conduit pipes are run on surface of the walls and ceilings, it is called a surface conduit wiring. If the conduits are run inside the surface of the walls and ceilings and are covered with plastering, it is called as concealed conduit wiring.

FUSE AND THEIR TYPES: -

A Fuse or an Electric Fuse is an Electrical / Electronic device that protects the circuit from different electrical faults like over current and overload. Fuses can be considered as a sacrificial element in the circuit as they act as a weak link in the entire circuit.

The principle of a fuse is based on the heating effect of the electric current. A simple fuse consists of a small conductive material with low resistance and it is placed in series with the circuit.

Different types of fuses are,

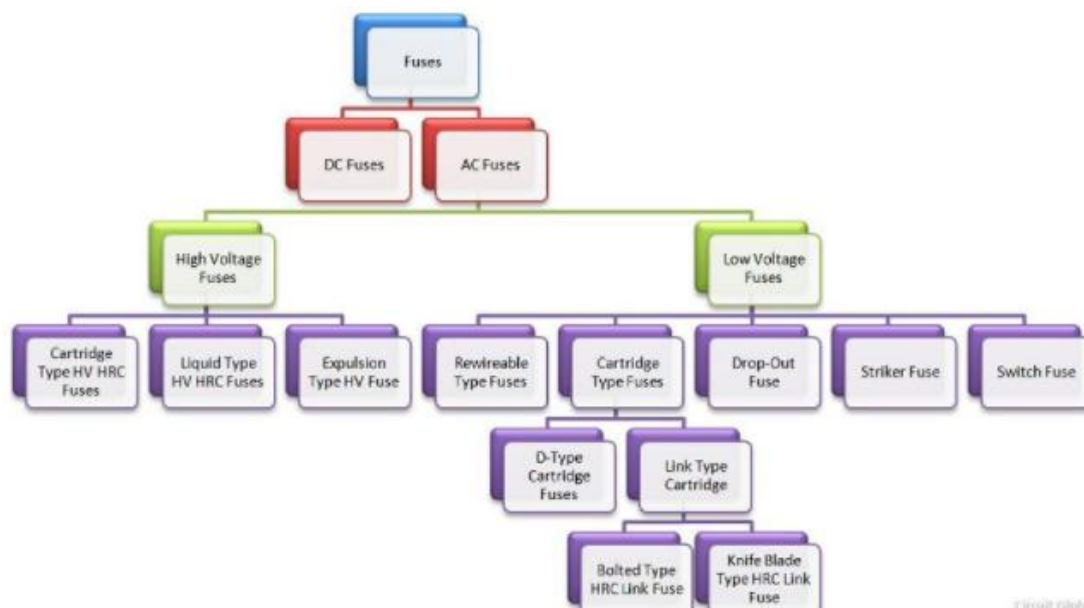

BUILDING SERVICES

DC Fuse

The DC fuse opens or breaks the circuit when the excessive current flow through it. The only difficulty with the DC fuse is that the arc produced by the direct current is very difficult to extinct because there are no zero current flows in the circuit. For reducing the DC fuse arcing the electrodes are placed more distance apart due to which the size of the fuse increases as compared to AC fuse.

AC Fuses

The AC fuses are categorised into two types they are the low voltage fuses and the high voltage fuses. The frequency of the AC fuses changes its amplitude from 0° to 60° in very one second. Thus, the arc extinction in the AC circuit can be done easily as compared to the DC circuit.

Rewirable Fuses

This type of circuit is mostly used in the small current circuit or for domestic wiring. The fuse case and the fuse carrier are the two main parts of the rewirable fuse. The base of the fuse is made up of porcelain, and it holds the wires which may be made up of lead, tinned copper, aluminium or alloy of tin-lead. The fuse carrier can be easily inserted or taken out in the base without opening the main switch.

Cartridge Type Fuses

The fuse element is totally enclosed in an enclosed container, and it has metal contacts on both sides. These fuses are further classified as D-type cartridge fuses and the Link type cartridge fuses.

D-Type Cartridge Fuses

The main parts of the D-type fuse are the base, adapter ring, cartridge and a fuse cap. The cartridge is kept in the fuse cap, and the fuse cap is fixed to the fuse base. The cartridge tip touches the conductor when it is completely screwed to the base and thus completes the circuit through the fuse links.

Link Type Cartridge or High Rupturing Capacity

In such type of fuses, the fuse element carries the fault current for a long duration. If the fault is not clear, then the fuse element will melt and open the circuit. The major advantage of HRC fuse is that it clears the low as well as a high fault current.

BUILDING SERVICES

Dropout Fuse

The melting of fuse causes the fuse element to drop out under gravity about its lower support. Such type of fuse is used for the protection of outdoor transformers.

Striker Fuse

It is a mechanical device having enough force and displacement which can be used for closing tripping/indicator circuits.

Switch Fuse

Such type of switches is used for low and medium voltages circuit. The rating of the fuse unit is in the range of 30, 60, 100, 200, 400, 600, and 800 amperes. The fuse unit is available as 3-pole and 4-pole unit. The making capacity of such type of fuses is up to 46 kA. They can safely break depending upon rating currents of the order of 3 times the load current.

Cartridge Type HV HRC Fuse

The fuse element of the HRC fuse is wound in the shape of the helix which avoids the corona effect at the higher voltages. It has two fused elements placed parallel with each other, one of low resistance and the other is of high resistance. The low resistance wire carries the normal current which is blown out and reducing the short circuit current during the fault condition.

Liquid Type HV HRC Fuse

Such type of fuses is filled with carbon tetrachloride and sealed at both the ends of the caps. When the fault occurs then the current, exceed beyond the permissible limit, and the fuse element is blown out. The liquid of the fuse acts as an arc extinguishing medium for the HRC fuses. They may be employed for the transformer protection and the backup protection to the circuit breaker.

Expulsion Type HV Fuse

Expulsion type fuses are widely used for the protection of feeders and transformer because of their low cost. It is developed for 11kV, and their rupturing capacity is up to 250 MVA. Such type of fuses comprises a hollow open-ended tube made of synthetic resin-bonded paper.

The fuse elements are placed in the tubes, and the ends of the tubes are connected to suitable fittings at each end. The arc producing is blown off in the inner coating of the tube, and the gases thus formed extinguish the arc.

BUILDING SERVICES

Requirement of lighting: -

The Requirements of good Light Good light is essential for efficient vision. Poor lightening lead to straining and eye fatigue. The following light factors are essential: 1.sufficiency 2.distribution 3.absence of glare 4.absence of sharp shadows 5.steadiness 6.color of light 7.surroundings.

Sufficiency Sufficient light is essential to recognize the surroundings details without eyes straining. An illumination of 15-20 foot candles is accepted as a basic minimum for satisfactory vision.

Distribution For efficient vision, lighting should be a uniform and of the same distribution all over the area without contrast; if not, eyes straining and fatigue occur.

Absence of glare Glare is excessive contrast. Glare may be from the direct light source or reflected from another object such a table tops and polished furniture. Glare causes annoyance. The eye can't tolerate glare because it causes acute discomfort and reduces critical vision.

Absence of sharp shadows Slight shadows are inevitable; but sharp and contrasting shadows are disturbing. Shadows causes confusion to the eyes and shouldn't be present in the vision field.

Steadiness The source of the light should be constant; and it shouldn't flicker, because flickering causes eye strain and may lead to accidents.

Color of the light The colour of the light is not very important so long as the intensity is adequate. Since the natural light has a comforting effect on the eye, the artificial light should be as far as possible approximate the daylight colour.

Surroundings For efficient vision the colour schemes in rooms is very important. Room item reflection factor: - Roofs80 % Walls50 - 60 % Furniture30 -40 % Floor≤ (10 – 20 %)

Measurement of light intensity: -

- Lumen is the measure of light intensity
- Lux represents 1 lumen per square meter.
- The fundamental unit of light is the candela. One candela per steradian is termed a lumen. One lux is one lumen per square meter.
- While light output is expressed in lumens, light intensity is measured in terms of lumens per square meter or lux.

BUILDING SERVICES

VENTILATION: -

Ventilation moves outdoor air into a building or a room, and distributes the air within the building or room. The general purpose of ventilation in buildings is to provide healthy air for breathing by both diluting the pollutants originating in the building and removing the pollutants from it.

Natural ventilation: -

Natural forces (e.g. winds and thermal buoyancy force due to indoor and outdoor air density differences) drive outdoor air through purpose-built, building envelope openings. Purpose-built openings include windows, doors, solar chimneys, wind towers and trickle ventilators. This natural ventilation of buildings depends on climate, building design and human behavior.

Mechanical/artificial ventilation: -

Mechanical fans drive mechanical ventilation. Fans can either be installed directly in windows or walls, or installed in air ducts for supplying air into, or exhausting air from, a room.

The type of mechanical ventilation used depends on climate. For example, in warm and humid climates, infiltration may need to be minimized or prevented to reduce interstitial condensation (which occurs when warm, moist air from inside a building penetrates a wall, roof or floor and meets a cold surface). In these cases, a positive pressure mechanical ventilation system is often used. Conversely, in cold climates, exfiltration needs to be prevented to reduce interstitial condensation, and negative pressure ventilation is used. For a room with locally generated pollutants, such as a bathroom, toilet or kitchen, the negative pressure system is often used.

In a positive pressure system, the room is in positive pressure and the room air is leaked out through envelope leakages or other openings. In a negative pressure system, the room is in negative pressure, and the room air is compensated by “sucking” air from outside. A balanced mechanical ventilation system refers to the system where air supplies and exhausts have been tested and adjusted to meet design specifications. The room pressure may be maintained at either slightly positive or negative pressure, which is achieved by using slightly unequal supply or exhaust ventilation rates. For example, a slight negative room pressure is achieved by exhausting 10% more air than the supply in a cold climate to minimize the possibility of interstitial condensation. In an airborne precaution room for infection control, a minimum negative pressure of 2.5 Pa is often maintained relative to the corridor.

***CONSTRUCTION
AND
EARTHMOVING
EQUIPMENTS***

CLASSIFICATION OF CONSTRUCTION EQUIPMENTS

- 1. EARTH MOVING EQUIPMENT**
- 2. HAULING EQUIPMENT**
- 3. HOISTING EQUIPMENT**
- 4. CONVEYING EQUIPMENT**
- 5. AGGREGATE AND CONCRETE PRODUCTION EQUIPMENT**
- 6. PILE DRIVING EQUIPMENT**
- 7. TUNNELING AND ROCK DRILLING EQUIPMENT**
- 8. PUMPING AND DEWATERING EQUIPMENT**
- 9. DREDGING EQUIPMENT**

FACTORS AFFECTING SELECTION OF CONSTRUCTION EQUIPMENT

- ❖ **USE OF EQUIPMENT AVAILABLE WITH THE ORGANIZATION**
- ❖ **SUITABILITY FOR JOB CONDITION WITH SPECIAL REFERENCE TO CLIMATIC AND OPERATING CONDITIONS**
- ❖ **UNIFORMITY OF TYPE**
- ❖ **SIZE OF EQUIPMENT**
- ❖ **USE OF STANDARD EQUIPMENT**
- ❖ **COUNTRY OF ORIGIN**
- ❖ **UNIT COST OF PRODUCTION**
- ❖ **AVAILABILITY OF SPARE PARTS AND SELECTION OF MANUFACTURERS**

EARTH MOVING EQUIPMENTS:

The equipment which perform excavation, digging of large quantities of earth, moving them to distances, placement, compacting, leveling, dozing, grading, hauling etc., are called earth moving equipment.

CLASSIFICATION:

- EXCAVATING EQUIPMENT
- EXCAVATING AND EARTH MOVING EQUIPMENT

TYPES OF EARTH MOVING EQUIPMENTS

- 1. POWER SHOVEL**
- 2. BULL DOZER**
- 3. DRAG LINE**
- 4. TRACTOR**

POWER SHOVEL

- LONG-LASTING.
- EXCAVATE ALL TYPES OF EARTH EXCEPT HARD ROCK

TYPES:

- WHEEL MOUNTED (HIGH SPEED - FIRM GROUND)
- CRAWLER MOUNTED (LOW SPEED - UNSTABLE SOIL)

BASIC PARTS:

* TRACK SYSTEM

* CABIN

* CABLES

* RACK & STICK

* BOOM FOOT PIN

* SADDLE BLOCK

* BOOM POINT SHEAVE

* BUCKET (Size = .375 m³ to 5 m³)

POWER SHOVEL

OPERATION:

CABLE CONTROLLED & IT MAKES *OUTWARD STROKES* WHILE DIGGING

APPLICATIONS:

- CLOSE RANGE OF WORK.
- VERY HARD MATERIALS, BIG SIZED BOULDERS.
- DIGGING IN GRAVEL BANKS, CLAY PITS, CUTS IN ROAD WORKS, ROAD SIDE BERMS Etc.,

FACTORS CONTROLLING OUTPUT:

- * CLASS OF MATERIAL
- * ANGLE OF SWING
- * SIZE OF HAULING UNITS
- * DEPTH OF CUTTING
- * SKILL OF OPERATOR
- * JOB CONDITION

POWER SHOVEL

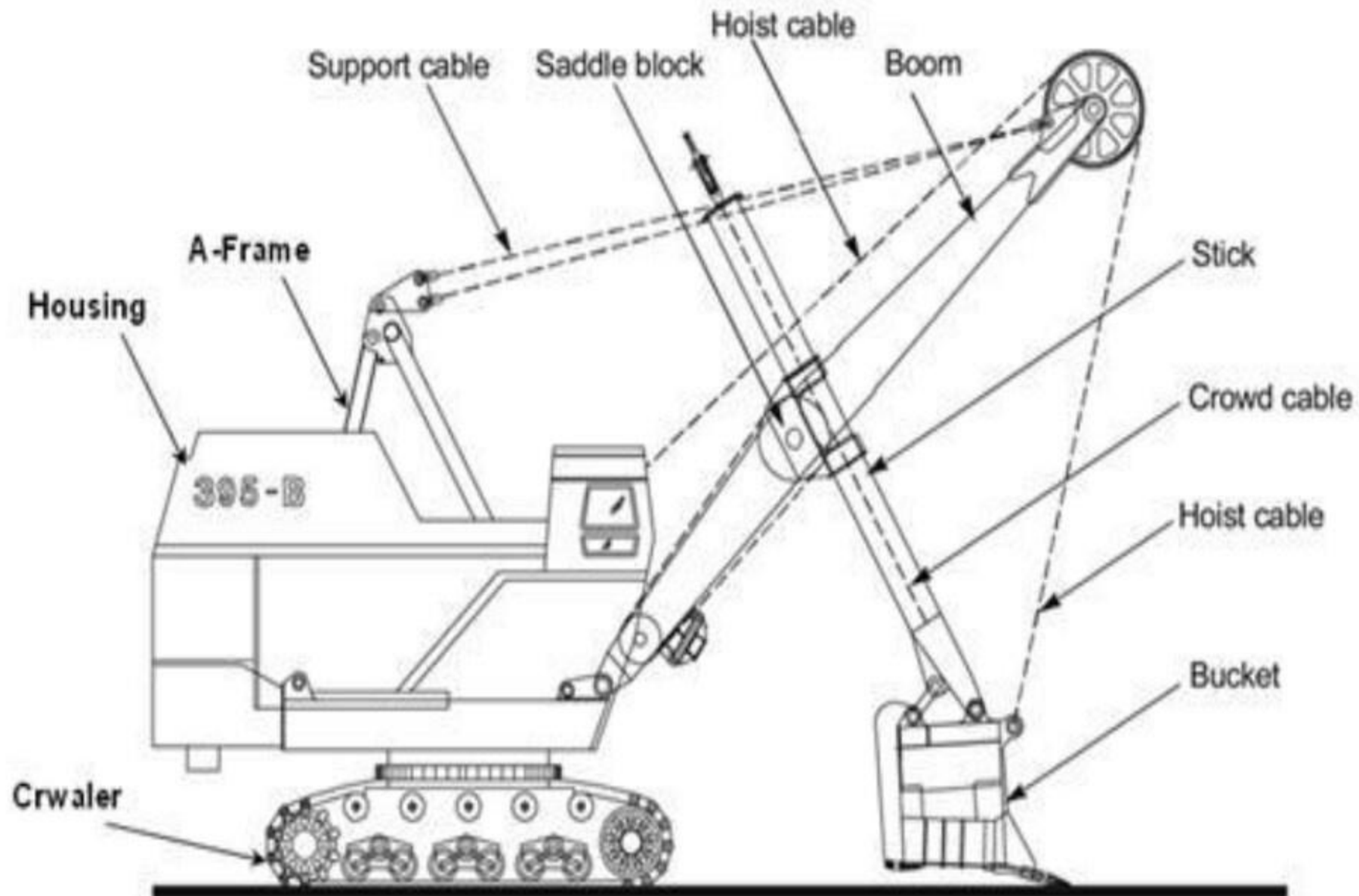

DRAG LINE

- The drag line is so name because of its prominent operation of dragging the bucket against the material to be dug.
- Unlike the shovel, it has a long light crane boom and the bucket is loosely attached to the boom through cables.
- Because of this construction, a dragline can dig and dump over larger distances than a shovel can do.

DRAG LINE

BASIC PARTS:

- * BOOM
- * DRAG CABLE
- * DRAG CHAIN
- * HOIST CABLE
- * HOIST CHAIN
- * BUCKET

APPLICATIONS:

- Dragging **softer material** and **below its track level**
- It is very useful for **excavating trenches** when the sides are **permitted to establish their angle of repose without shoring.**

DRAG LINE

FACTORS CONTROLLING OUTPUT:

- **TYPE OF MATERIAL**
- **DEPTH OF CUTTING**
- **SIZE AND TYPE OF BUCKETS**
- **SKILL OF OPERATOR**
- **SIZE OF HAULING UNITS & METHOD**
- **ANGLE OF SWING**

LINE DIAGRAM OF DRAGLINE

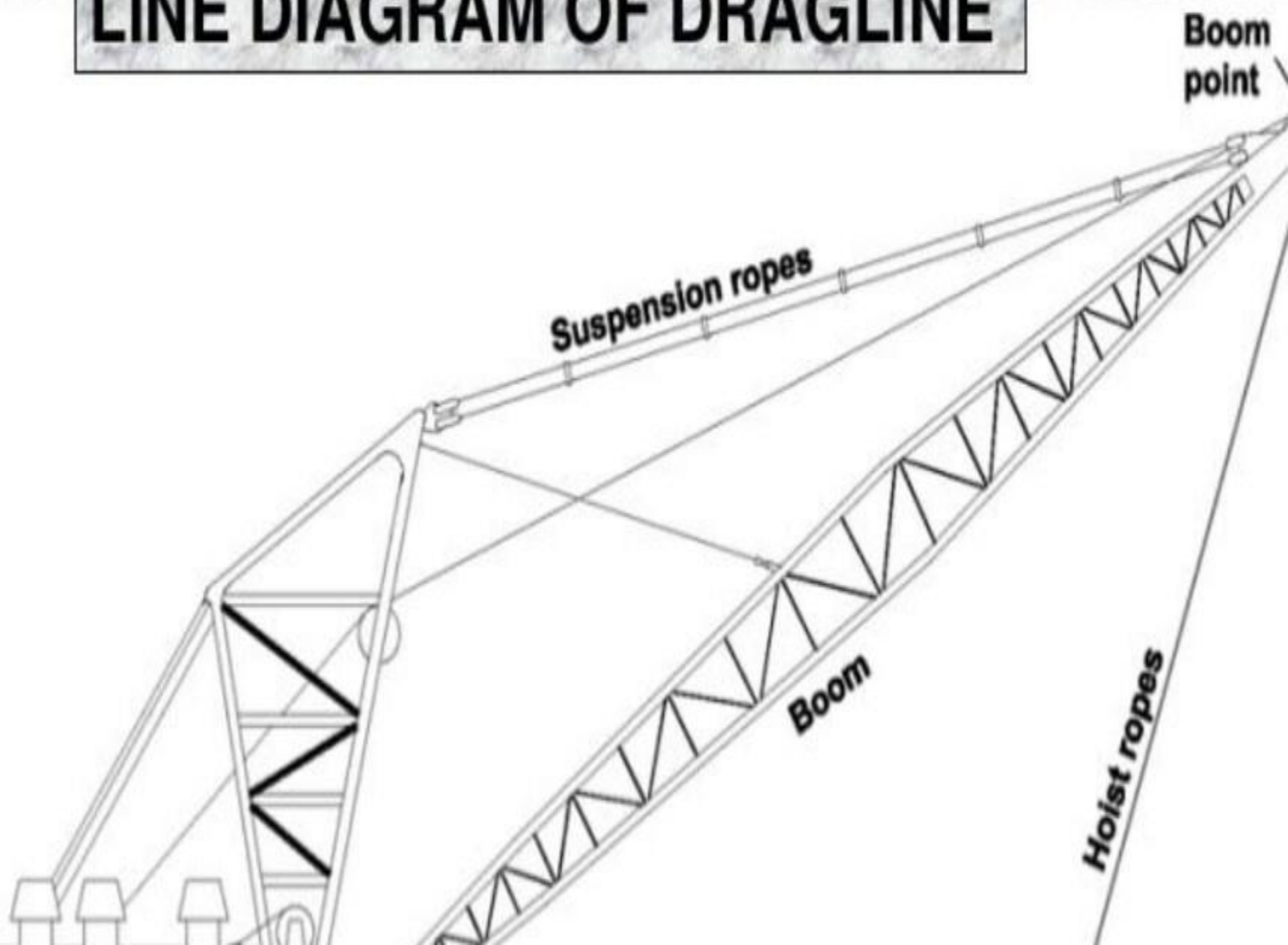

BULL DOZERS

- VERSATILE EQUIPMENT- ESSENTIALLY A HEAVY STEEL BLADE MOUNTED ON THE FRONT OF TRACTOR.

CLASSIFICATION BASED ON:

POSITION OF BLADES

- PERPENDICULAR BLADES
- BLADES AT AN ANGLE

MOUNTING

- WHEEL MOUNTED
- CRAWLER MOUNTED

BULL DOZERS

CONSTRUCTION:

- ❖ **CONSIST OF HEAVY BLADE WITH CONCAVE PROFILE.**
- ❖ **BLADE IS ATTACHED TO THE BODY WITH TWO ARMS, A SUPPORTING FRAME & HELD BY TWO PUSH ARMS**

APPLICATION:

- ❖ **SPREADING EARTH FILL**

▲ **CLEARING OPENING UP PLOT BOARDS**

BULL DOZERS



TRACTORS

- ❑ MULTI PURPOSE MACHINES MAINLY USED FOR PULLING AND PUSHING OTHER MACHINES FOR AGRICULTURAL PURPOSES.

TYPES:

1. WHEEL TYPE (<50 km/Hr)
2. CRAWLER TYPE (<12 km/Hr)

APPLICATIONS:

EARTH COMPACTION EQUIPMENTS

- 1. SMOOTH – WHEEL ROLLERS**
- 2. SHEEP – FOOT ROLLERS**
- 3. PNEUMATIC TYRED ROLLERS**

SMOOTH – WHEEL ROLLERS:

- PLAIN STEEL ROLLERS
- SELF – PROPELLED (5 TO 25 TONNES)
- NO DEEP COMPACTION
- REAR WHEELS ARE LARGER IN DIAMETER AND THE FRONT ONES ARE WIDER
- DIESEL ENGINE TYPE
- COMPACTION IS BY STATIC WEIGHT OF ROLLER

SUITABILITY:

- GRANULAR SOILS

SMOOTH WHEEL ROLLER



SHEEP – FOOT ROLLERS

- ❑ HOLLOW STEEL DRUM WITH PROJECTED FEET MOUNTED AT
100 TO 200 MMC/C**
- ❑ WEIGHT - 15 TONNES**
- ❑ SPEED - 25 KM/HR**
- ❑ COMPACTION IS BY KNEADING ACTION**
- ❑ IN CONVERTIBLE ROLLERS THE FOOT PLATE CAN BE
REMOVED**

SHEEP - FOOT ROLLERS



PNEUMATIC TYRED ROLLERS

- ✓ **CONSISTS OF A BASE PLATFORM MOUNTED BETWEEN TWO AXLES**
- ✓ **TRACKS OF THE REAR WHEEL LIE INBETWEEN THE TRACKS OF THE FRONT WHEEL**
- ✓ **COMPACTION IS BY CONTROLLING THE GROUND CONTACT PRESSURE**
- ✓ **WEIGHT OR WIDTH OF THE WHEEL CAN BE SUITABLY**

PNEUMATIC TYRED ROLLER



SOIL REINFORCING TECHNIQUES

Necessity of soil reinforcing: -

- Soil reinforcement is a technique used to improve the stiffness and strength of soil using geo-engineering methods.
- It is particularly useful in areas with soft soil as it cannot provide adequate support to any construction or building.
- With the help of this technique, we can increase the engineering property of soil such as shear strength, bearing capacity, reduction in permeability, reduction in compressibility, etc.
- Soil reinforcement is also a process of improving soil stability against slope failure.
- So, with the help of soil reinforcement, we can make more durable, stable, and free from the settlement.

Materials of soil reinforcement: -

There are 3 main materials which are commonly used in the construction of reinforced soil. They are: -

- Soil or fill matrix
- Reinforcement or anchor system
- Geosynthetics

Soil or fill matrix: -

It means using well graded cohesionless or good cohesive frictional soils because of the following advantages like.

- They are stable
- Free draining
- Not susceptible to frost
- Relatively noncorrosive to reinforcing elements

Reinforcement or anchor system: -

A wide range of materials such as steel, glass, concrete, fibre, wood, aluminium, rubber and thermoplastics can be used as reinforcing agents. These reinforcements can take the structural forms of strips, grids, sheets or a combination of these.

- Strips:- These are flexible linear elements, having their thickness less than their breadth. They can be comprised of copper, polymers, aluminium, glass fibre or bamboo. Galvanised or coated steel strips are paired with either plain or with projects to increase the friction between reinforcement and fill.

SOIL REINFORCING TECHNIQUES

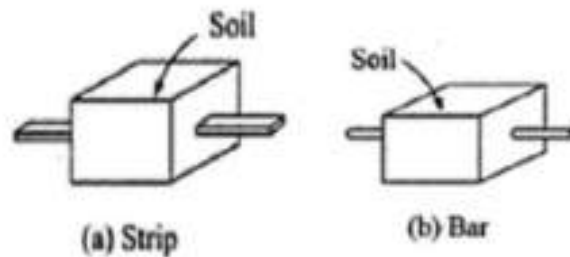

- Grids: - Grids are also used as reinforcements. They consist of steel (in the form of plain or galvanised weld mesh/ expanded metal).

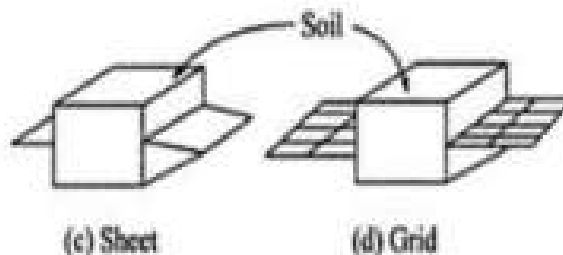

- Sheets: - This reinforcement may be formed from fabric or metals such as galvanised steel sheet and expanded metals.

Similarly, composite reinforcements can be developed by using different materials and forms to suit the soil conditions. The principal requirements of reinforcing materials are their strength, stability, durability, handling, coefficient of friction and soil compatibility. Factors such as cost and availability are also accounted for while choosing the soil reinforcement materials.

Geosynthetics: -

Geosynthetics refers to man made products; they are flexible in nature and planar (sheet like). These materials are manufactured from synthetic polymers and sometimes are comprised of natural materials. These are vital in the engineering field as they are used as filters, drains, reinforcements, barriers and have erosion control applications.

Geotextiles are a permeable synthetic textile material; this is generally produced from polyester or polypropylene polymers. These are used to increase the overall soil strength, stability, prevent erosion and aid in drainage. A range of geotextiles can be produced using various manufacturing processes and different polymers; they can be woven or non-woven. Woven geotextiles are made by interlacing 2 or more fibres (at right angles). Non-woven geotextiles are produced by mechanical bonding or needle punching.

Geogrids is a geosynthetic material with a mesh like structure which has square or rectangular openings that are larger than the thickness of the ribs. The thickness of ribs ranges from 5 to 15mm, and the mass varies from 200 to 1500gms.

SOIL REINFORCING TECHNIQUES

Effect of soil reinforcement: -

- Reinforcement improves the strength and bearing capacity of the soil.
- The increased numbers of layers and confining pressure lead to an improvement in the performance of reinforced soil.
- Compaction behavior of soil is affected by fibre inclusion with an increase of fibre content dry density is reduced and a marginal increase in optimum moisture content (OMC) is noted.
- Fibre reinforcement increases the tensile strength of soil with an increase in dry density.
- It is observed that the stress-strain behaviour of soil has changed from brittle to ductile with the inclusion of basalt fibre.

Applications of soil reinforcement: -

Embankments on weak foundations:

The main challenge for embankments on weaker foundations such as airports near soft or sandy ground is to reinforce the soil and stabilise it.

Retaining walls:

Geotextiles are combined with different kinds of wall applications such as on-site fills to reinforce the supporting walls. Geotextile provides an alternative to traditional methods such as cast-in-place concrete structures for retaining walls.

Subgrade Stabilising:

For soft and organic soils, the tensile strength is low. The cost required for traditional land filling can be up to 50% higher than the cost of soil reinforcement with geotextiles. Geotextiles can be utilised to disperse the load uniformly within the soil and reduce the displacement of small soil particles.

Reinforcing Base Course:

By increasing tensile strength of granular base course material, the overall load bearing capacity of soft soil is improved. The use of geotextiles increases the tensile strength by increasing its load bearing capacity at the granular base structure. A grid is commonly used for this.

Steeping Slopes:

Layers of geotextiles are placed methodically on the land to steepen soil slopes. This achieves overall increase of tensile strength without the risks of soils sliding or rotating.