

## Induction Motor

### Construction :

The induction motor mainly divided in to two parts.

- (1) Stator                      (2) Rotor

In case of D. C. Motor basically it is divided into two main parts (i) Yoke (ii) Armature. Yoke is outer & stationary part, similarly the outer portion of the induction motor is known as stator. It is also stationary part of the induction motor. The stator of the induction motor is cylindrical in shape.

The inner part of D. C. Motor i.e., armature is rotating in nature. Similarly the rotating part of the induction motor is known as rotor. The rotor lies inside the stator. It is cylindrical in shape.

Rotor is divided into two types.

- (i) Squirrel cage Rotor  
(ii) Phase wound Rotor or Slip ring Rotor,

Figure shows the disassembled view of an induction motor with squirrel cage rotor.

- (a) Stator (b) Rotor (c) bearing shields (d) Fan (e) Ventilation grill (f) terminal box.

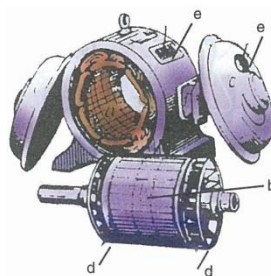

**Fig 1.1**

Similarly figure shows the disassembled view of a slip ring motor (a) stator (b) rotor (c) bearing shields (d) Fan (e) Ventilation grill (f) Terminal box (g) Slip ring (h) brushes & brush holder.

## Production of Rotating Magnetic Field :

When 3 – phase stationary coils are fed with 3 – phase supply, a uniformly rotating magnetic flux of constant magnitude will produce.

It will now be shown that when three – phase winding displaced in space by  $120^\circ$ , are fed by three phase currents, displaced in time by  $120^\circ$ , they produce a resultant magnetic flux, which rotates in space as if actual magnetic poles were being rotated mechanically.

The principle of a 3 – phase, two pole stator having three identical windings placed  $120^\circ$  space degree apart as shown in fig – 1.2. The flux due to three phase windings is shown in fig 1.3.

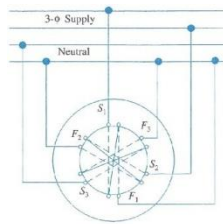

**Fig 1.2**

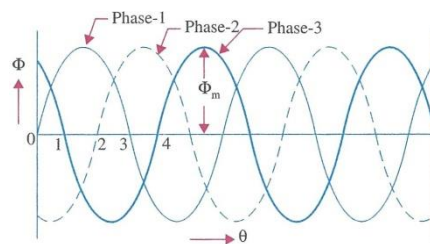

**Fig 1.3**

Let the maximum value of flux due to any one of the three phases be  $\phi_m$ . The resultant flux  $\phi_r$ , at any instant is given by the vector sum of the individual fluxes  $\phi_1$ ,  $\phi_2$  and  $\phi_3$  due to three phases. Considering values of  $\phi_r$  at four instants i.e.  $1/6^{\text{th}}$  time period apart corresponding to points marked 0, 1, 2 & 3.

**Proof :**

Case – 1 : Resultant flux at origin i.e. when  $\theta = 0^0$  At that time  $\phi_1 = 0$ ,

$$\phi_2 = \phi_m \sin < -120^0 = -\frac{\sqrt{3}}{2} \phi_m \quad \phi_3 = \phi_m \sin < -240^0 = -\frac{\sqrt{3}}{2} \phi_m.$$

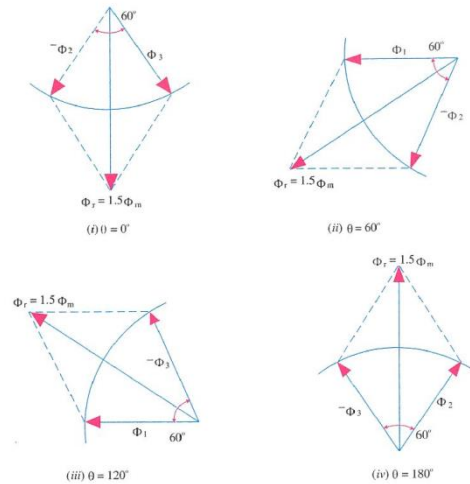
**Fig 1.4**

Resultant flux  $\phi_r$  :

As per law of parallelogram

$$\phi_r^2 = \phi_2^2 + \phi_3^2 + 2 \phi_2 \times \phi_3 \times \cos 60^0$$

$$\Rightarrow \phi_r^2 = \left( \frac{\sqrt{3}}{2} \phi_m \right)^2 + \left( \frac{\sqrt{3}}{2} \phi_m \right)^2 + 2 \cdot \frac{\sqrt{3}}{2} \phi_m \times \frac{\sqrt{3}}{2} \phi_m \cdot \frac{1}{2}$$

$$\Rightarrow \phi_r^2 = \frac{3}{4} \phi_m^2 + \frac{3}{4} \phi_m^2 + \frac{3}{4} \phi_m^2$$

$$\Rightarrow \phi_r^2 = \frac{9}{4} \phi_m^2$$

$$\Rightarrow \phi_r = \frac{3}{2} \phi_m$$

$$\Rightarrow \phi_r = 1.5 \phi_m$$

Case – II : When  $\theta = 60^0$

$$\text{Therefore } \phi_1 = \phi_m \sin < 60^0 = \frac{\sqrt{3}}{2} \phi_m$$

$$\phi_2 = \phi_m \sin < -120^\circ + 60^\circ = \phi_m \sin < -60^\circ = \frac{-\sqrt{3}}{2} \phi_m$$

$$\text{and } \phi_3 = \phi_m \sin < -240^\circ + 60^\circ = \phi_m \sin < -180^\circ = 0$$

case – III When  $\theta = 120^\circ$

$$\phi_1 = \phi_m \sin < 120^\circ = \frac{\sqrt{3}}{2} \phi_m$$

$$\phi_2 = \phi_m \sin < -120^\circ + 120^\circ = \phi_m \sin < 0^\circ = 0$$

$$\phi_3 = \phi_m \sin < -240^\circ + 120^\circ = \phi_m \sin < -120^\circ = \frac{-\sqrt{3}}{2} \phi_m$$

$\phi_r$  can be calculated as earlier

$$\text{Similarly } \phi_r = 1.5\phi_m$$

Case – IV When  $\theta = 180^\circ$

$$\phi_1 = \phi_m \sin < 180^\circ = 0$$

$$\phi_2 = \phi_m \sin < -120^\circ + 180^\circ = \phi_m \sin < 60^\circ = \frac{\sqrt{3}}{2} \phi_m$$

$$\phi_3 = \phi_m \sin < -240^\circ + 180^\circ = \phi_m \sin < -60^\circ = \frac{-\sqrt{3}}{2} \phi_m$$

Similarly  $\phi_r$  can be calculated as earlier  $\phi_r = 1.5 \phi_m$

Hence from the above four cases we can draw a conclusion that the resultant flux ( $\phi_r$ ) inside the stator winding at any time =  $1.5 \phi_m$  and the resultant flux ( $\phi_r$ ) rotates around the stator at synchronous speed.

### **How the rotor rotates :**

The rotor lies inside the stator. There is an air gap in between the stator and rotor. The stator slots are provided with three Phase winding.

When three phase stator windings are fed by a 3-phase supply then a rotating magnetic flux of constant magnitude will produce.

This rotating flux passes through air gap and cuts the stationary conductors on the rotor . There is also a 3-phase rotor winding on the rotor. The stator and rotor windings act as

primary and secondary windings of a 3-phase transformer. The air gap acts as core of the transformer. The fluxes pass from stator to rotor winding through induction principle.

The rotating flux produces an emf in the rotor winding. The rotor winding is closed circuit. Hence current will flow in the rotor conductors. When current will flow it will produce the flux in the air gap. The flux in the rotor winding interacts with the flux in the stator winding there by producing a torque, which is responsible for the rotation of the rotor.

### **Slip(s) :**

The rotor never succeeds in catching up with the stator field. If it really did so, then there would be no relative speed between the two, hence no rotor emf, no rotor current and so no torque to maintain rotation. That is why the rotor runs at a speed which is always less than the speed of the stator field.

The difference between synchronous speed  $N_s$  to the actual speed of the rotor  $N_r$  is known as slip speed.

$$\text{Slip speed} = N_s - N_r.$$

$$\text{Slip (s) or \% of Slip (s)} = \frac{N_s - N_r}{N_s} \times 100$$

$$\Rightarrow S = \frac{N_s - N_r}{N_s}$$

$$\Rightarrow N_s - N_r = SN_s$$

$$\Rightarrow N_s - SN_s = N_r$$

$$\Rightarrow N_s(1-S) = N_r$$

Therefore Rotor speed  $N_r = N_s (1-S)$

### **Frequency of Rotor Current :**

When the rotor is stationary, the frequency of rotor current is the same as the supply frequency. But when the rotor starts revolving, then the frequency depends upon the relative speed. Let the frequency of the rotor current be  $f'$

$$\text{Hence} \quad N_s - N_r = \frac{120 f'}{P}$$

$$\begin{aligned} \text{As } N_s &= \frac{120f}{P} \\ \Rightarrow \frac{N_s - N_r}{N_s} &= \frac{120f'}{P} \times \frac{P}{120f} \\ \Rightarrow S &= \frac{f'}{f} \\ \text{Therefore } f' &= Sf \end{aligned}$$

Hence Rotor frequency = slip x supply frequency

### Torque of an Induction Motor :

The torque of an induction motor is the torque produced at the rotor. Hence  $T = T_r$  where  $T_r$  is the rotor torque.

In case of D.C. motor torque = Armature Torque =  $T_a$

$$T_a = 0.159 \phi Z I_a \left( \frac{P}{A} \right) \text{ Nxm}$$

Therefore  $T_a = K \phi I_a$

[Where 0.159, Z, P and A are all constants)

Where  $\phi$  is the flux produced by the filed winding which is pulsating in nature.

Similarly in case of an induction motor the torque is also proportional to the product of flux produced in stator and rotor current.

However there is another factor which is to be taken is power factor. Because in this case both flux and current are alternating in nature.

Therefore  $T_r \propto \phi I_2 \cos \phi_2$

Where  $I_2$  – Rotor Current

$\phi$  - flux produced in the stator.

$\phi_2$  – The phase angle between rotor emf and rotor current ( $E_2$  and  $I_2$ )

As  $\phi \propto E_2$

Therefore  $T_r = T \propto E_2 I_2 \cos \phi_2$

$$T = K E_2 I_2 \cos \phi_2$$

### Starting Torque :

The torque developed by the motor at the instant of starting is called starting torque.

Let  $E_2$  = Rotor emf per phase at stand still

$R_2$  = Rotor resistance / phase

$X_2$  = Rotor reactance / phase at stand still

$Z_2 = \sqrt{R_2^2 + X_2^2}$  = Rotor impedance / phase at stand still

$$\text{Then } I_2 = \frac{E_2}{Z_2} = \frac{E_2}{\sqrt{R_2^2 + X_2^2}}, \cos \phi_2 = \frac{R_2}{Z_2} = \frac{R_2}{\sqrt{R_2^2 + X_2^2}}$$

Stand still or starting torque  $T_{st} = K E_2 I_2 \cos \phi_2$

$$\text{Or } T_{st} = K E_2 \times \frac{E_2}{\sqrt{R_2^2 + X_2^2}} \times \frac{R_2}{\sqrt{R_2^2 + X_2^2}} = \frac{K E_2^2 R_2}{R_2^2 + X_2^2}$$

If supply voltage  $V$  remains constant, then the flux  $\phi$  and hence  $E_2$  remain constant.

$$\text{Therefore } T_{st} = K_1 \frac{R_2}{R_2^2 + X_2^2}$$

$$\Rightarrow T_{st} = K_1 \frac{R_2}{Z_2^2}$$

### Starting Torque of a Squirrel – cage Induction Motor :

The resistance of a squirrel cage motor is fixed and small as compared to its reactance which is very large especially at the start because at stand still, the frequency of the rotor currents equal the supply frequency. Hence the starting current  $I_2$  of the rotor, though very large in magnitude, lags by a very large angle  $E_2$ , with the result that the starting torque per ampere is very poor. Hence, such motors are not useful where the motor has to start against heavy loads.

### Starting Torque of a slip-ring motor :

The starting torque of such motor is increased by improving its power factor by adding external resistance in the rotor circuit from the star connected rheostat, the rheostat resistance

being progressively cut out as the motor gathers speed. Addition of external resistance, however increases the rotor impedance and so reduces the rotor current. At first, the effect of improved power factor predominates the current-decreasing effect of impedance. Hence, starting torque is increased. But after a certain point, the effect of increased impedance predominates the effect of improved power factor and so the torque starts decreasing.

### Condition for maximum starting Torque :

$$\text{As starting torque } T_{st} = \frac{K_2 R_2}{R_2^2 + X_2^2}$$

From mathematics we know that differentiation of a maximum quantity = 0

$D(T_{st}) = 0$ , when  $T_{st} = \text{Maximum starting Torque}$

$$\text{Therefore } \frac{d(T_{st})}{dR_2} = 0$$

$$\Rightarrow \frac{d}{dR_2} \left( \frac{K_2 R_2}{R_2^2 + X_2^2} \right) = 0$$

$$\Rightarrow K_2 \frac{d}{dR_2} \left( \frac{R_2}{R_2^2 + X_2^2} \right) = 0$$

$$\Rightarrow \frac{d}{dR_2} \left( \frac{R_2}{R_2^2 + X_2^2} \right) = 0$$

$$\Rightarrow \frac{(R_2^2 + X_2^2) \times \frac{d}{dR_2} R_2 - R_2 \frac{d}{dR_2} (R_2^2 + X_2^2)}{(R_2^2 + X_2^2)^2} = 0$$

$$\Rightarrow R_2^2 + X_2^2 \times 1 - R_2 (2R_2 + 0) = 0$$

$$\Rightarrow R_2^2 + X_2^2 - 2R_2^2 = 0$$

$$\Rightarrow X_2^2 = R_2^2$$

$$\Rightarrow R_2 = X_2$$

Hence the starting torque will be maximum when Rotor resistance = Rotor Reactance.



### Rotor EMF and Rotor reactance under running condition :

Rotor EMF : Let  $E_2 =$  Stand still rotor EMF / phase

$X_2 =$  Stand still rotor reactance / phase

When rotor starts rotating, the relative speed between rotor and rotating flux in the stator starts decreasing.

$$\text{Slip (s)} = \frac{N_s - N_r}{N_s}$$

The rotor induced emf is directly proportional to this relative speed

i.e.  $E_r \propto (N_s - N_r) E_2$

$$\Rightarrow E_r = K (N_s - N_r) E_2$$

$$\Rightarrow E_r = \frac{N_s - N_r}{N_s} \times E_2$$

Therefore  $E_r = S E_2$

### Rotor Reactance :

The frequency of the rotor current

$$f_r = sf$$

Therefore  $X_r = 2\pi s f_r L$

$$\Rightarrow X_r = 2 \pi s f L$$

$$\Rightarrow X_r = S (2\pi f L)$$

Therefore  $X_r = S X_2$

### Torque under running conditions :

As we know that starting torque  $T_{st} = K E_2 I_2 \cos \phi_2$

Therefore  $T_{st} \propto E_2 I_2 \cos \phi_2$

So the torque under running condition  $T_r \propto E_r I_r \cos \phi_r$

Where  $E_r =$  Rotor EMF/Phase under running condition

$I_r =$  Rotor Current/Phase under running condition

$$A_s E_r \propto \phi$$

Therefore  $T_r \propto \phi I_r \times \cos \phi_r$

$$I_r = \frac{E_r}{Z_r} \quad \text{But } Z_r = R_2 + j X_r = R_2 + j S X_2$$

$$\cos \phi_r = \frac{R_2}{\sqrt{R_2^2 + (S X_2)^2}} \quad \text{and } I_r = \frac{S E_2}{\sqrt{R_2^2 + (S X_2)^2}}$$

Therefore running torque  $T_r \propto E_r I_r \cos \phi_r$

$$\text{Therefore } T_r \propto \phi \frac{S E_2}{\sqrt{R_2^2 + (S X_2)^2}} \times \frac{R_2}{\sqrt{R_2^2 + (S X_2)^2}}$$

$$\Rightarrow T_r \propto \phi \frac{S E_2 R_2}{R_2^2 + (S X_2)^2}$$

$$\Rightarrow \text{As } E_2 \propto \phi$$

$$\text{Otenu } T_r \propto \frac{S E_2^2 R_2}{R_2^2 + (S X_2)^2}$$

$$\text{Therefore } T_r = \frac{K_1 S E_2^2 R_2}{R_2^2 + (S X_2)^2}$$

### Torque under stand still condition :

$N_r = 0$  at stand still condition

$$S = \frac{N_s - 0}{N_s} = 1$$

Therefore torque under stand still condition

$$T_r = \frac{K E^2 R}{R_2^2 + X_2^2}$$

### Condition for maximum Torque under running condition :

The torque of a rotor under running condition

$$T_r = \frac{K S E^2 R}{R_2^2 + (S X_2)^2}$$

The conditions for maximum torque may be obtained by differentiating the above equation w.r.t slip (s) and then putting it equal to zero.

Let  $Y = \frac{1}{T_r}$  (For to make the differentiation easy)

$$\text{Therefore } Y = \frac{R_2^2 + (SX_2)^2}{K S E_2^2 R_2}$$

$$\Rightarrow Y = \frac{R_2}{K S E_2^2} + \frac{S X_2^2}{K E_2^2 R_2}$$

For maximum torque under running condition  $\frac{dY}{dS} = 0$

$$\Rightarrow \frac{d}{dS} \left( \frac{R_2}{K S E_2^2} \right) + \frac{d}{dS} \left( \frac{S X_2^2}{K E_2^2 R_2} \right) = 0$$

$$\Rightarrow \frac{d}{dS} \left( \frac{R_2}{S E_2^2} \right) + \frac{d}{dS} \left( \frac{S X_2^2}{E_2^2 R_2} \right) = 0$$

$$\Rightarrow \frac{\frac{dR_2}{dS} \times S E_2^2 - R_2 \frac{d(S E_2^2)}{dS}}{(S E_2^2)^2} + \frac{\frac{d(S X_2^2)}{dS} \times E_2^2 R_2 - \frac{d(E_2^2 R_2)}{dS} \times (S X_2^2)}{(E_2^2 R_2)^2} = 0$$

$$\Rightarrow \frac{0 - \times E_2^2 R_2}{S^2 E_2^4} + \frac{X_2^2 E_2^2 R_2 - 0}{E_2^4 R_2^2} = 0$$

$$\Rightarrow \frac{- R_2 E_2^2}{S^2 E_2^4} + \frac{X_2^2}{E_2^2 R_2} = 0$$

$$\Rightarrow \frac{R_2}{S^2 E_2^2} = \frac{X_2^2}{E_2^2 R_2}$$

$$\Rightarrow \frac{R_2}{S^2} = \frac{X_2^2}{R_2}$$

$$\Rightarrow R_2^2 = S^2 X_2^2$$

Therefore  $\boxed{R_2 = S X_2}$

Hence the torque under running condition will be maximum when  $R_2 = S X_2$

As the torque under running condition

$$T_r = \frac{K S E_2^2 R_2}{R_2^2 + (S X_2)^2}$$

Putting the value  $R_2 = SX_2$

$$\text{Therefore } T_r = T_r (\text{max}) = \frac{K S E_2^2 \times S X_2}{(S X_2)^2 + (S X_2)}$$

$$\Rightarrow T_r (\text{max}) = \frac{K S^2 E_2^2 X_2}{2 S^2 X_2^2} = \frac{K E_2^2}{2 X_2}$$

Hence 
$$T_r (\text{max}) = \frac{K E_2^2}{2 X_2}$$

### Relation between full load Torque and Maximum Torque :

$$\text{As Torque } (T) = \frac{K_1 S E_2^2 R_2}{R_2^2 + (S X_2)^2}$$

$E_2$  is practically constant

$$\text{Hence } T = \frac{K_2 S R_2}{R_2^2 + (S X_2)^2}$$

$$\text{Therefore } T \propto \frac{S R_2}{R_2^2 + (S X_2)^2}$$

Taking full load slip as  $S_f$  at full load torque  $T_f$

$$\text{Therefore } T_f \propto \frac{S_f R_2}{R_2^2 + (S_f X_2)^2} \quad \dots\dots\dots (I)$$

$$\text{As } T_{\text{max}} = \frac{K E_2^2}{2 X_2}$$

$$T_{\text{max}} \propto \frac{1}{2 X_2} \quad \dots\dots\dots (II)$$

$$\frac{(i)}{(ii)} = \frac{T_f}{T_{\text{max}}} = \frac{S_f R_2}{R_2^2 + (S_f X_2)^2} \times \frac{2 X_2}{1}$$

$$\frac{T_f}{T_{\text{max}}} = \frac{2 S_f R_2 X_2}{R_2^2 + (S_f X_2)^2}$$

Dividing  $X_2^2$  on both side

$$\frac{T_{\square f}}{T_{\max}} = \frac{2S_f \frac{R_2}{X_2}}{\frac{R_2^2}{X_2^2} + S_f^2}$$

Taking  $\frac{R_2}{X_2} = a$

$$\Rightarrow \frac{T_f}{T_{\max}} = \frac{2aS_f}{a^2 + S_f^2}$$

In general  $\frac{\text{operating Torque}}{\text{Maximum Torque}} = \frac{2as}{s^2 + a^2}$

s – operating slip

### **Relation between starting Torque and Maximum Torque :**

$$\text{As } T_{\text{st}} = K \frac{R_2}{R_2^2 + X_2^2}$$

$$\Rightarrow T_{\text{st}} \propto \frac{R_2}{R_2^2 + X_2^2} \dots\dots\dots (i)$$

$$\text{But } T_{\max} \propto \frac{1}{2X_2} \dots\dots\dots (ii)$$

$$\frac{(i)}{(ii)} \Rightarrow \frac{T_{\text{st}}}{T_{\max}} = \frac{R_2}{R_2^2 + X_2^2} \times \frac{2X_2}{1}$$

$$\Rightarrow \frac{T_{\text{st}}}{T_{\max}} = \frac{2R_2 X_2}{R_2^2 + X_2^2}$$

$$\Rightarrow \frac{T_{\text{st}}}{T_{\max}} = \frac{2R_2 X_2}{\frac{R_2^2}{X_2^2} + X_2^2}$$

$$\Rightarrow \frac{T_{\text{st}}}{T_{\max}} = \frac{2R_2}{\left( \frac{R_2}{X_2} \right)^2 + 1}$$

$$\Rightarrow \boxed{\frac{T_{st}}{T_{max}} = \frac{2a}{a^2 + 1}}$$

### Relation between Torque and slip :

$$\text{As Torque (T)} = \frac{KSE_2^2 R_2}{R_2^2 + (SX_2)^2}$$

Taking Torque in Y axis and slip in X axis

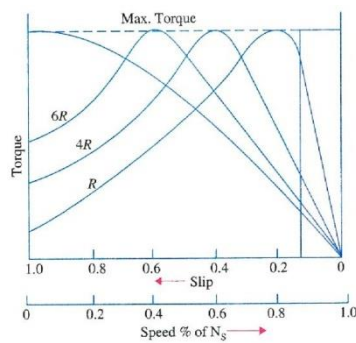

**Fig. 1.5**

At origin i.e.  $S = 0$ , torque  $T = 0$

Therefore the curve starts from origin. At normal speed, closed to synoronism that is when  $N_r$  is very near to  $N_s$ , then slip is very nearly equal to zero.

Therefore  $SX_2 \ll R_2$

$$\Rightarrow T \propto \frac{SE_2^2 R_2}{R_2^2} \quad \{\text{Neglecting } (SX_2)^2\}$$

(Taking supply voltage constant so  $E_2$  is also constant)

$$\Rightarrow T \propto \frac{S}{R_2}$$

For a particular induction motor  $R_2$  is constant.

Hence  $T \propto S$

Therefore low valve of slip, torque is directly proportional to slip. Hence the curve is straight line for low valve of slip.

As slip increases the torque also increases and becomes maximum when  $R_2 = SX_2$

$$\text{i.e. } S = \frac{R_2}{X_2}$$

As the slip further increases  $(SX_2)$  becomes higher compare to  $R_2$ .

Hence  $R_2$  can be neglected in compare to  $(SX_2)$

$$\Rightarrow T \propto \left( \frac{S}{SX_2} \right)^2$$

$$\Rightarrow T \propto \frac{1}{SX_2^2}$$

Taking  $X_2$  is constant for a particular induction motor

$$\text{Therefore } T \propto \frac{1}{S}$$

So beyond the point of maximum torque any further increase in slip, results in decrease of torque.

### Method of starting of Induction Motor

The operation of the squirrel cage induction motor is similar to transformer having short circuited on the secondary side.

Due to short circuited on the rotor circuit it will take heavy current when it is directly switched on. Generally when direct switched, take five to seven times of their full load current. This initial excessive current is objectionable, because it will produce large line voltage drop.

Hence it is not advisable to start directly motors of rating above 5 KW. But the starting torque of an induction motor can be improved by increasing the resistance of the rotor circuit. This is easily feasible in the case of slip ring induction motor but not in the case of squirrel cage motors. However, in their case, the initial inrush of current is controlled by applying a reduced voltage to the stator during the starting period, full normal voltage being applied when the motor has run up to speed.

### Method of Starting of Squirrel Cage Motor :

- (1) Resistors Method
- (2) Star – Delta Method
- (3) Auto transformer Method

In the above methods, the supply voltage to the squirrel cage motor is reduced during starting.

#### 1) Resistor Method :

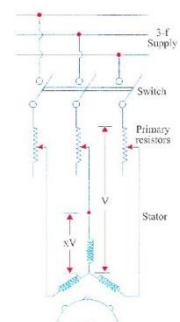

In this method the resistors are connected in series with the stator phases, to give reduced voltage to the stator winding.

When resistors are connected in series with the stator phases, the current in the stator phases will reduce. If the voltage applied across the motor terminals is reduced by 50%, starting current is reduced by 50%.

**Fig 1.6**

When the motor starts running the resistances in the circuit is gradually cut out and full voltage is applied to the stator circuit. This method is useful for the smooth starting of small machines only.

## 2) Star – Delta Starter :

This method is used in the case of motors which are built to run normally with a delta connected stator winding. It consists of a two way switch which connects the motor in star for starting and then in delta for normal running.

At starting, when star connected, the applied voltage over each motor phases is reduced by a factor  $\frac{1}{\sqrt{3}}$ . Hence during starting, when motor is star connected it takes  $\frac{1}{\sqrt{3}}$  times as much as starting current.

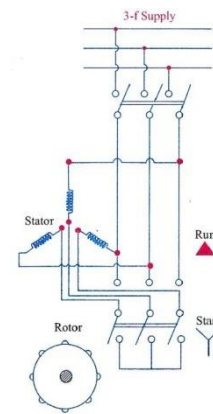

**Fig 1.7**

When the motor catches the speed 80% of its normal speed switch is changed to delta positions at that time  $V_L = V_{ph}$ .

## Auto Transformer Method :

This starter is popularly known as auto starter in auto transformer the secondary side gets less voltage in compare to primary side.

As shown in the figure, at starting condition, a reduced voltage is applied across the mo terminals. When the motor catches the speed 80% of its normal speed, connections are changed to running position, then full supply voltage is applied across the motor.

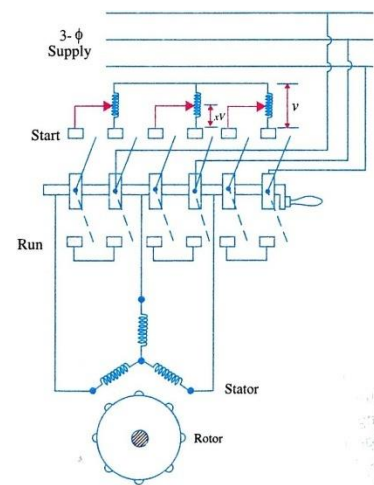

**Fig 1.8**



Most of the auto starters are provided with 3 – sets of taps so as to reduced the voltage to 80, 65 or 50 percent of line voltage.

### Slip ring Motor :

#### Rotor Rheostat Method :

These motors are practically always started with full line voltage applied across the stator terminals. The value of starting current is adjusted by introducing a variable resistance in the rotor circuit.

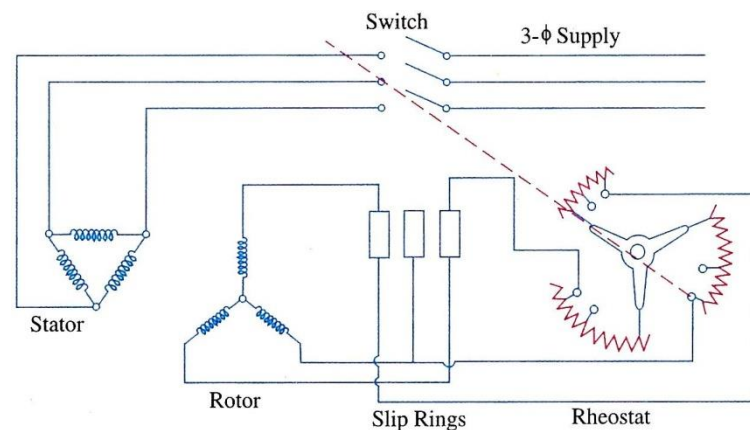

**Fig 1.9**

The controlling resistance is in the form of a rheostat, connected in star, the resistance being gradually cut – out of the rotor circuit, as the motor gathers speed

### Speed Control of Induction Motor :

The speed of an induction motor can be changed under two main headings.

(i) **Control from stator side**

(ii) **Control from Rotor side**

(i) **Control from stator side :**

- (a) By changing the applied voltage
- (b) By changing the applied frequency
- (c) By changing the no of stator poles.

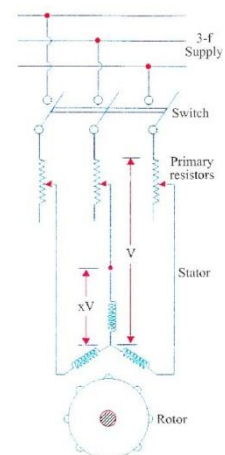

**(ii) Control from Rotor side :**

- (a) Rotor Rheostatic Control
- (b) Cascade operation
- (c) By injecting emf in the rotor circuit

**Fig 1.10****By changing applied voltage :**

This method is the easiest way for controlling speed of an induction motor. But this method is rarely used for the following reasons.

- (i) A large change in voltage is required for a small change in speed.
- (ii) Due to the connection of resistances in the stator phases, large power loss occurs at the resistors.

When the resistances are added in the stator circuit, voltage across the stator phase decreases.

$$\text{As torque (T)} = \frac{KV^2R_2}{R_2^2 + X_2^2}$$

$$\Rightarrow \text{Torque } T = K_1 V^2$$

$$\Rightarrow T \propto V^2$$

The torque depends on the supply voltage on the stator terminals, when V will decrease T will decrease hence speed will decrease.

**By Charging the number of stator poles :**

This method is easily applicable to squirrel cage motors because the squirrel cage rotor adopts it self to any reasonable number of stator poles.

The change in number of stator poles is achieved by having two more entirely independent stator windings in the same slots. Each winding gives a different number of poles and hence different synchronous speed.

**Rotor Rheostatic Control :**

This method is applicable to slip ring motors alone. The motor speed is reduced by introducing an external resistance in the rotor circuit.

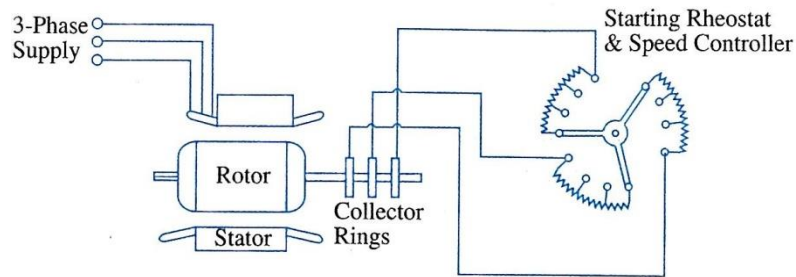

**Fig 1.11**

For this purpose the rotor starter may be used.

$$\text{As torque (T)} \propto \frac{S}{R_2}$$

By increasing the motor resistance torque will decrease. Hence speed will decrease.

### Motor Enclosures :

Enclosed and semi-enclosed motors are practically identical with open motors in mechanical construction and in their operating characteristics. Many different types of frames or enclosures are available to suit particular requirements. Some of the common type of enclosures are given below.

- (i) Totally enclosed, Non ventilated type.
- (ii) Splash – Proof type
- (iii) Totally enclosed, Fan cooled type.
- (iv) Cowl covered motor
- (v) Protected Type
- (vi) Drip – Proof Motors
- (vii) Self (Pipe) Ventilated Type
- (viii) Separately (Forced) Ventilated Type.

### Induction Generator :

When the rotor of an induction motor runs faster than its synchronous speed at that time the induction motor runs as a generator called Induction generator. It converts the mechanical energy it receives into electrical energy is released by the stator.

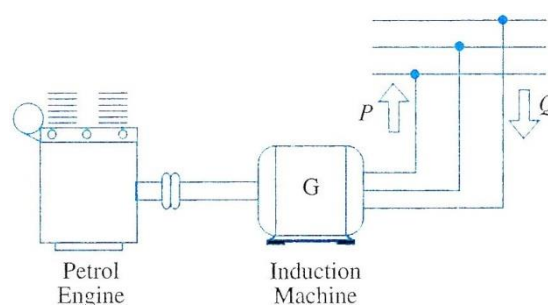

**Fig 12**

Figure shows a ordinary squirrel cage induction motor which is driven by a petrol engine and is connected to a 3 – phase line. As soon as motor speed exceeds its synchronous speed, it starts delivering active power  $P$  to the 3 – phase line. However, for creating its own magnetic field, it absorbs reactive power  $Q$  from the line to which it connected.

-0-

## (Alternators)

### INTRODUCTION

An alternating voltage is generated in a single conductor/coil **rotating** in a uniform magnetic field with **stationary** field poles .Similarly, an alternating voltage will also be generated in a **stationary** conductor/coil when the field poles **rotate** past the conductor/coil , as it is the **relative motion** between the field and the conductor/coil that matters so far as emf induction in a conductor/coil is concerned. The wave shapes of voltage in both the cases are sinusoidal as the wave shape of magnetic flux is sinusoidal.

In D.C. generators , the field poles are **stationary** and the armature conductors **rotate**.The voltage generated in the armature conductors is of alternating nature. This generated alternating voltage is converted to a direct voltage at the brushes with the help of the commutator.

A.C. generators are usually called **Alternators**. They are also called Synchronous generators. Rotating machines that rotate at a speed fixed by the supply frequency and the number of poles are called synchronous machines.

A synchronous generator is a machine for converting mechanical power from a prime mover to ac electric power at a specific voltage and frequency .A synchronous machine rotates at a constant speed called the **synchronous speed**.Synchronous machines are usually of 3-phase type because of various advantages of 3-phase Generation,Transmission and Distribution.Large synchronous generators of several MVA ratings are used to generate bulk power at thermal ,hydro and nuclear power stations.

### ADVANTAGES OF ROTATING FIELD ALTERNATOR

Most alternators have the rotating field and the stationary armature.The rotating-field type alternator has several advantages over the rotating-armature type alternator.

- (1) A stationary armature is more easily insulated for the high voltage for which the alternator is designed. This generated voltage may be as high as 33KV.
- (2) The armature windings can be braced better mechanically against high electro-magnetic forces due to large short-circuit currents when the armature windings are in the stator.
- (3) The armature windings, being stationary, are not subjected to vibration and centrifugal forces.

- (4) The output current can be taken directly from fixed terminals on the stationary armature without using slip rings, brushes, etc.
- (5) The rotating field is supplied with direct current. Usually the field voltage is between 100 to 500 volts. Only two slip rings are required to provide direct current for the rotating field while at least three slip rings would be required for a rotating armature. The insulation of the two relatively low voltage slip rings from the shaft can be provided easily.
- (6) The bulk and weight of the armature windings are substantially greater than the windings of the field poles. The size of the machine is, therefore, reduced.
- (7) Rotating field is comparatively light and can be constructed for high speed rotation. The armatures of large alternators are forced cooled with circulating gas or liquids.
- (8) The stationary armature may be cooled more easily because the armature can be made large to provide a number of cooling ducts.

**SPEED AND FREQUENCY**

The frequency of the generated voltage depends upon the number of field poles and on the speed at which the field poles are rotated. One complete cycle of voltage is generated in an armature coil when a pair of field poles (one north and one south pole) passes over the coil.

Let P =total number of field poles

P= pair of field poles

N= speed of the field poles in r.p.m.

n=speed of the field poles in r.p.s.

f= frequency of the generated voltage in Hz

Obviously  $\frac{N}{60} = n$ ..... 1.1

and  $\frac{P}{2} = p$ ..... 1.2

In one revolution of the rotor, an armature coil is cut by  $\frac{P}{2}$  north poles and  $\frac{P}{2}$  south poles. Since one cycle is generated in an armature coil when a pair of field poles passes over the coil, the number of cycles generated in one revolution of the rotor will be equal to the number of pairs of poles. That is,

Number of cycles per revolution = p

Also, number of revolutions per second=n

Now frequency=number of cycles per second

$$f = \frac{\text{number of cycles}}{\text{revolutions}} \times \frac{\text{revolutions}}{\text{seconds}}$$

$$f = p \times n \dots\dots\dots 1.3$$

Since n =N/60 and p=p/2

$$f = \frac{N}{120} \dots\dots\dots 1.4$$

Equation(1.2) and (1.4) give the relationship between the number of poles, speed and frequency.

### SYNCHRONOUS SPEED

From Eq.(1.4)

$$N_s = \frac{120f}{p} \dots\dots\dots (1.5)$$

Equation (1.5) shows that the rotor speed N bears a constant relationship with the field poles and the frequency of the generated voltage in the armature winding. The speed given by Eq. (1.5) is called synchronous speed  $N_s$ . A machine which runs at synchronous speed is called synchronous machine. Thus, a synchronous machine is an a.c. machine in which the rotor moves at a speed which bears a constant relationship to the frequency of the generated voltage in the armature winding and the number of poles of the machine. Table 1.1 gives the number of poles and synchronous speeds for a power frequency of 50Hz.

**Table 1.1**

Number of poles	Synchronous speed $N_s$ in r.p.m.
2	3000
4	1500
6	1000
8	750
10	600
12	500

**EXAMPLE 1.1**

Calculate the highest speed at which (a)  $50\text{Hz}$  (b)  $60\text{Hz}$  alternator can be operated.

Solution

Since it is not possible to have fewer than 2 poles, the minimum value of  $p=2$ .

$$f = \frac{N_s}{60} \cdot \frac{p}{2}$$

$$N_s = \frac{60 \cdot f \cdot 2}{p}$$

For a minimum value of  $P$  the speed  $N$  will be a maximum.

(a)  $f=50\text{Hz}$ ,  $p=2$

$$N_s = \frac{60 \cdot 50 \cdot 2}{2} = 3000\text{r.p.m. (Ans.)}$$

(b)  $f=60\text{Hz}$ ,  $p=2$

$$N_s = \frac{60 \cdot 60 \cdot 2}{2} = 3600\text{r.p.m. (Ans.)}$$

## CONSTRUCTION OF THREE-PHASE SYNCHRONOUS MACHINES

Similar to other rotating machines, an alternator consists of two main parts namely, the stator and the rotor. The stator is the stationary part of the machine. It carries the armature winding in which the voltage is generated. The output of the machine is taken from the stator. The rotor is the rotating part of the machine. The rotor produces the main field flux.

### STATOR CONSTRUCTION

The various parts of the stator include the frame, stator core, stator windings and cooling arrangement. The frame may be of cast iron for small-size machines and of welded steel type for large size machines. In order to reduce hysteresis and Eddy-current losses, the stator core is assembled with high grade silicon content steel laminations. A 3-phase winding is put in the short cut on the inner periphery of the stator as shown in Fig.1. The winding is star connected. The winding of each phase is distributed over slots. When current flows in a distributed winding it produces an essentially sinusoidal space distribution of emf.



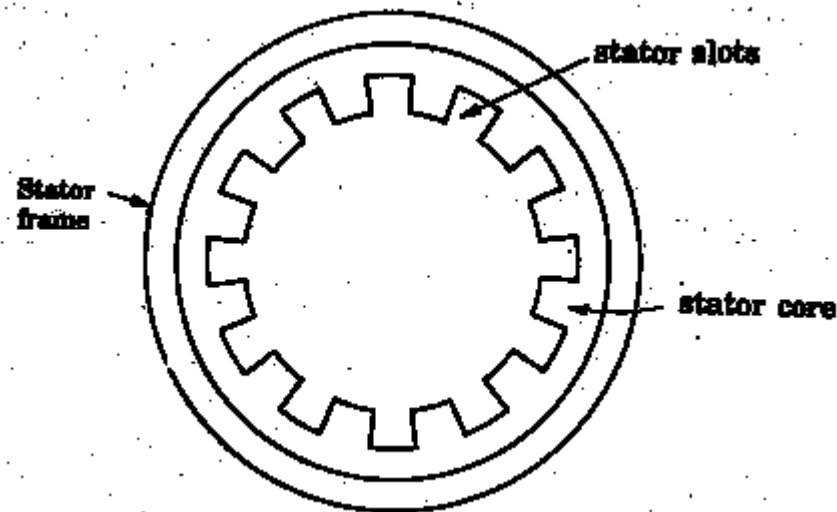

Figure 1.1 Alternator stator

## ROTOR CONSTRUCTION

There are two types of rotor constructions namely, the salient-pole type and the cylindrical rotor type.

### Salient-Pole Rotor

The term salient means '**protruding**' or '**projecting**'. Thus, a salient-pole rotor consists of poles projecting out from the surface of the rotor cor. Figure 1.2 shows the end view of a typical 6-pole salient-pole rotor. Salient-pole rotors are normally used for rotors with four or more poles.

Since the rotor is subjected to changing magnetic fields, it is made of this steel laminations to reduce eddy current losses. Poles of identical dimensions are assembled by stacking laminations to the required length and then riveted together. After placing the field coil around each pole body, these poles are fitted by a dove-tail joint to a steel spider keyed to the shaft. Salient-pole rotors have concentrated winding on the poles. Damper bars are usually inserted in the pole faces to damp out the rotor oscillations during sudden change in load conditions. A salient-pole synchronous machine has a non-uniform air gap. The air gap is minimum under the pole centres and it is maximum in between the poles. The pole faces are so shaped that the radial air gap length increases from the pole centre to the pole tips so that the flux distribution in the air gap is sinusoidal. This will help the machine to generate sinusoidal emf.

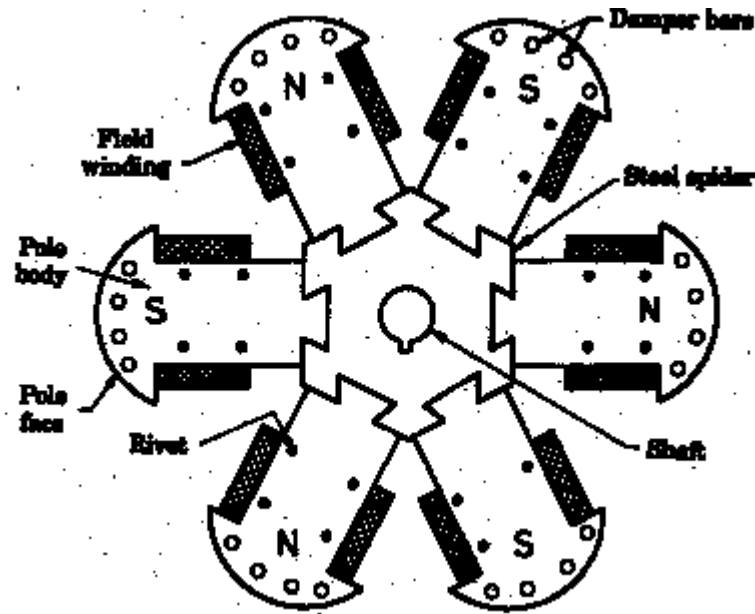

Figure 1.2 Six-pole salient-pole rotor

The individual field-pole windings are connected in series to give alternate north and south polarities. The ends of the field windings are connected to a dc source (a dc generator or a rectifier) through the brushes on the slip rings. The slip rings are metal rings mounted on the shaft and insulated from it. They are used to carry current to or from the rotating part of the machine (usually ac machine) via carbon brushes.

Salient-pole generators have a large number of poles at lower speeds. A salient-pole generator has comparatively a large diameter and a short axial length. The large diameter accommodates a large number of poles.

Salient-pole alternators driven by water turbines are called **hydro-alternators** or **hydro-generators**. Hydro-generators with relatively higher speeds are used with impulse turbines and horizontal configuration. Hydro-generators with lower speeds are used with reaction and Kaplan turbines and have vertical configuration.

## Cylindrical Rotor

A cylindrical-rotor machine is also called a **non-salient pole rotor machine**. It has rotor so constructed that it forms a smooth cylinder. The construction is such that there are no physical poles to be seen as in the salient-pole construction. Cylindrical rotors are made from solid forgings of high grade nickel-chrome-molybdenum steel. In about two-third of the rotor periphery, slots are cut at regular intervals and parallel to the shaft. The dc field windings are accommodated in these slots. The winding is of distributed type. The un-slotted portion of the rotor forms two (or four) pole faces. A cylindrical rotor machine has a comparatively small

diameter and long axial length. Such a construction limits the centrifugal forces. Thus, cylindrical rotors are particularly useful in high-speed machines. The cylindrical rotor type alternator has two or four poles on the rotor. Such a construction provides a greater mechanical strength and permits more accurate dynamic balancing. The smooth rotor of the machine makes less windage losses and the operation is less noisy because of **uniform air gap**.

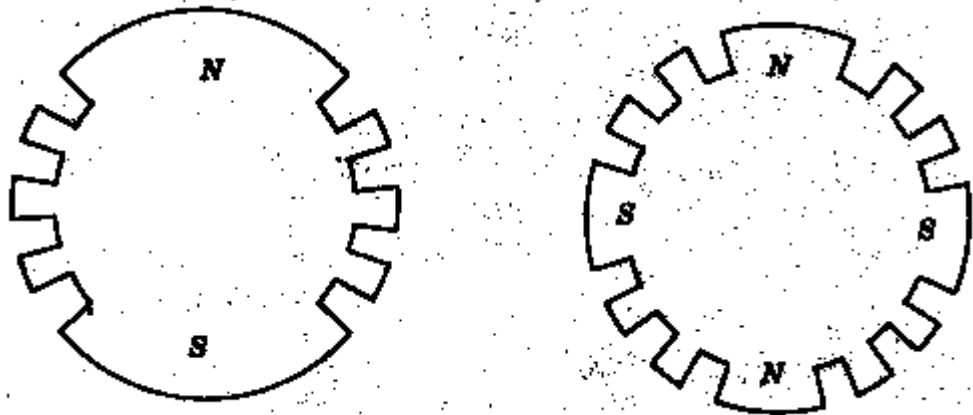

**Figure 1.3 End views of two-pole and four pole cylindrical rotors**

Figure 1.3 shows end views of 2-pole and 4-pole cylindrical rotors. Cylindrical rotor machines are driven by steam or gas turbines. Cylindrical rotor synchronous generators are called turbo-alternators or turbo-generators. Such machines have always horizontal configuration installation. The machines are built in a number of ratings from 10 MVA installed in super thermal power plants.

## **EXCITATION SYSTEMS FOR SYNCHRONOUS MACHINES**

Excitation means production of flux by passing current in the field winding.

Direct current is required to excite the field winding on the rotor of the synchronous machines. For small machines, dc is supplied to the rotor field by a dc generator called exciter. This exciter may be supplied current by a smaller dc generator called **pilot exciter**. The main and pilot exciters are mounted on the main shaft of the synchronous machine(generator or motor).The dc output of the main exciter is given to the field winding of the synchronous machine through brushes and slip rings. In smaller machines, the pilot exciter may be omitted, but this arrangement is not very sensitive or quick acting when changes of the field current are required by the synchronous machine.

For medium size machines a.c. exciters are used in place of d.c. exciters. A.C. exciters are three-phase a.c. generators. The output of a.c. exciter is rectified and supplied through brushes and slip-rings to the rotor winding of the main synchronous machine.

For large synchronous generators with ratings of few hundred megawatts, the excitation requirements become very large. The problem of conveying such amounts of power through high-speed sliding contacts becomes formidable. At present, large synchronous generators and synchronous motors are using brushless excitation systems. A brushless exciter is a small direct-coupled a. c. generator with its field circuit on the stator and the armature circuit on the rotor. The three-phase output of the ac exciter generator is rectified by solid-state rectifiers. The rectified output is connected directly to the field winding, thus eliminating the use of brushes and slip rings.

A brushless excitation system requires less maintenance due to absence of brushes and slip rings. The power loss is also reduced.

The d. c. required for the field of the exciter itself is sometimes provided by a small pilot exciter. A pilot exciter is a small a. c. generator with permanent magnets mounted on the rotor shaft and a three-phase winding on the stator. The permanent magnets of the pilot exciter produce the field current of the exciter. The exciter supplies the field current of the main machine. The use of a pilot exciter makes the excitation of the main generator completely independent of external supplies.

## VOLTAGE GENERATION

The rotor of the alternator is run at its proper speed by its *prime mover*. The prime mover is a machine which supplies the mechanical energy input to the alternator. The prime movers used for a low and medium speed alternators are water wheels or hydraulic turbines. Steam and gas turbines are used as prime movers in large alternators and run at high speeds. The steam-turbine driven alternators are called *turboalternators* or *turbogenerators*. As the poles of the rotor move under the armature conductors on the stator, the field flux cuts armature conductors. Therefore voltage is generated in these conductors. This voltage is of alternating nature, since poles of alternate polarity successively pass by a given stator conductor. A 3-phase alternator has a stator with three sets of windings arranged so that there is a mutual phase displacement of  $120^\circ$ . These windings are connected in star to provide a 3-phase output.

### E. M.F. EQUATION OF AN ALTERNATOR

$\Phi$  = useful flux per pole in webers (Wb)

P= total number of poles

$Z_p$  = total number of conductors or coil sides in series per phase

$T_p$  = total number of coils or turns per phase

$n$  = speed of rotation of rotor in revolutions per second (r. p. s)

$f$  = frequency of generated voltage (Hz)

Since the flux per pole is  $\Phi$ , each stator conductor cuts a flux  $P\Phi$ .

The average value of generated voltage per conductor

$$= \frac{\text{revolution in Wb}}{\text{time taken for one revolution in seconds}}$$

Since  $n$  revolutions are made in one second, one revolution will be made in  $1/n$  second.

Therefore the time for one revolution of the armature is  $1/n$  second. The average voltage generated per conductor

$$E_{av}/ \text{conductor} = \frac{P\Phi}{\frac{1}{n}} = np\Phi \text{ volts} \dots\dots\dots 1.6$$

We know that  $f = \frac{Pn}{120} = \frac{Pn}{2} \dots\dots\dots 1.7$

$$Pn = 2f$$

Substituting the value of  $Pn$  in Eq.(1.6), we get

$$E_{av}/ \text{conductor} = 2f\Phi \dots\dots\dots 1.8$$

Since there are  $Z_p$  conductors in series per phase, the average voltage generated per phase is given by

$$E_{av}/ \text{phase} = 2f\Phi Z_p \dots\dots\dots 1.9$$

Since one turn or coil has two sides,  $Z_p = 2T_p$ , and the expression for the average generated voltage per phase can be written as

$$E_{av}/ \text{phase} = 4f\Phi T_p \dots\dots\dots 1.10$$

For the voltage wave, the form factor is given by

$$k_f = \frac{\text{r.m.s.value}}{\text{average value}}$$

For a sinusoidal voltage,  $k_f = 1.11$ . Therefore, the r.m.s. value of the generated voltage per phase can be written as

$$E_{r.m.s}/\text{phase} = k_f \times E_{av}/\text{phase} = 1.11 \times 4f\Phi T_p$$

$$= 4.44 f\Phi T_p$$

The suffix r. m. s. is usually deleted, The r.m.s. value of the generated voltage per phase is given by

$$E_p = 4.44f\Phi T_p \dots\dots\dots 1.11$$

Equation( 1.11) has been derived with the following assumptions :

- (a) Coils have got full pitch.
- (b) All the conductors are concentrated in one stator slot.

## ARMATURE WINDINGS

The winding through which a current is passed to produce the main flux is called the *field winding*. The winding in which voltage is induced is called *armature winding*. For synchronous machines the field windings are on the rotor. Therefore, the terms **rotor windings** and **field windings** are used interchangeably. Also, the armature windings are on the stator. Therefore, the term stator windings and armature windings are used interchangeably.

Some basic terms related to the armature winding are defined as follows :

A TURN consists of two conductors connected to one end by an end connector.

A coil is formed by connecting several turns in series .

The turn ,Coil and windings are shown schematically in figure 1.4.

The beginning of the turn, or coil, is identified by the symbol S(Start) and the end of the turn or coil by the symbol F(Finish).

The concept of electrical degrees is very useful in the study of machine. If

$\theta_{mech}$  = mechanical degrees or angular measure in space

$\theta_{elect}$  = electrical degrees or angular measure in cycles

For a P-pole machine electrical degree is defined as follows:

$$\theta_{elec} = \frac{p}{2} \theta_{mech}$$

The advantage of this notation is that expressions written in terms of electrical angles apply to machines having any number of poles.

The angular distance between the centres of two adjacent poles on a machine is known as pole pitch or pole span.

$$\text{One pole pitch} = 180_{ed}^{\circ} = \frac{360}{p}$$

Regardless of the number of poles in the machine, a pole pitch is always 180 electrical degrees.

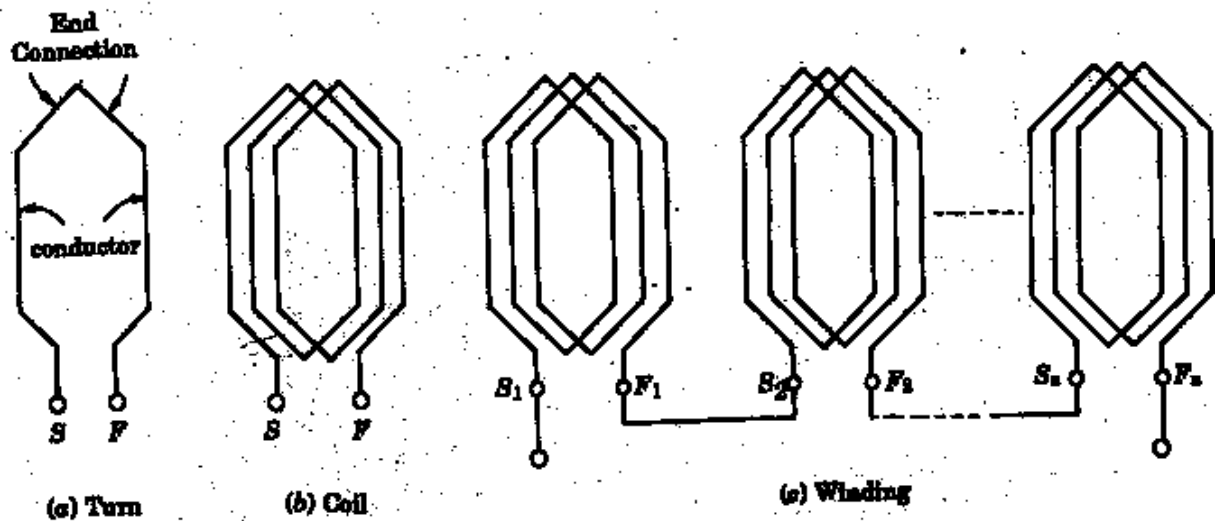

Figure 1.4 Turn, coil and winding

## COIL-SPAN FACTOR OR PITCH FACTOR

The distance between the two sides of a coil is called the *coil span* or coil pitch. The angular distance between the central line of one pole to the central line of the next pole is called *pole pitch*. A pole pitch is always 180 electrical degrees regardless of the number of poles on the machine. A coil having a span equal to 180 degree electrical is called a *full-pitch* coil as shown in figure 1.5(a).

A coil having a span less than 180 electrical degrees is called a short-pitch coil or fractional pitch coil. It is also called a chorded coil. A stator winding using fractional-pitch coils is called a *chorded* winding. If the span of the coil is reduced by an angle of electrical  $\alpha$  degrees, the coil span will be  $(180 - \alpha)$  electrical degrees as shown in figure 1.6(a).

In case of full-pitch coil two coil sides span a distance exactly equal to the pole pitch of 180 electrical degrees. As a result, the voltage generated in a full-pitch coil is such that the coil side voltages are in phase as shown in figure 1.5(b). Let  $E_{C1}$  &  $E_{C2}$  be the voltages generated in the coil sides and  $E_C$  the resultant coil voltage. Then

$$E_C = E_{C1} + E_{C2}$$

Let  $|E_{C1}| = |E_{C2}| = E_1$

Since  $E_{C1}$  &  $E_{C2}$  are in phase, the resultant coil voltage  $E_C$  is equal to their arithmetic sum.

$$E_C = E_{C1} + E_{C2} = 2 E_1$$

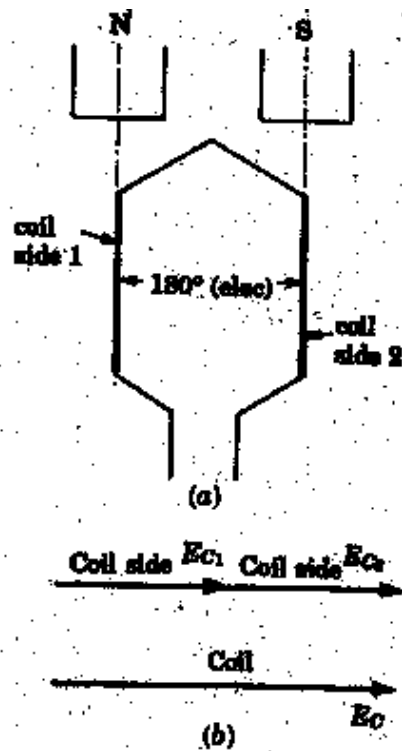

Fig. 1.5

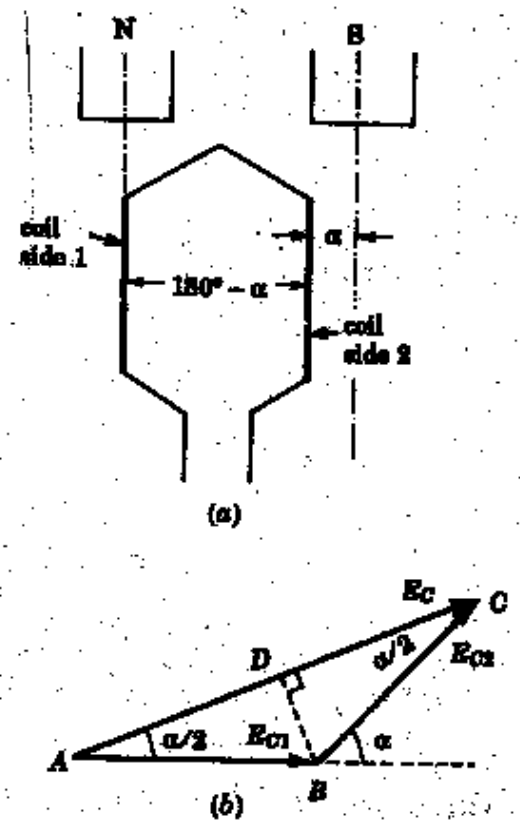

Fig. 1.6



If the coil span of a single coil is less than the pole pitch of  $180^\circ$  (elec.), the voltage generated in each coil side are *not* in phase. The resultant coil voltage  $E_c$  is equal to the *phasor sum* of  $E_{c1}$  &  $E_{c2}$ .

If the coil span is reduced by an angle  $\alpha$  electrical degrees, the coil span is  $(180 - \alpha)$  electrical degrees. The voltage generated  $E_{c1}$  &  $E_{c2}$  in two coil sides will be out of phase w.r.t each other by an angle  $\alpha$  electrical degree as shown in figure 1.6(b). The phasor sum of  $E_{c1}$  &  $E_{c2}$  is  $E_c (=AC)$ .

The coil span factor or pitch factor  $k_c$  is defined as the ratio of voltage generated in the short-pitch coil to the voltage generated in the full-pitch coil. The coil span factor is also called the *chording factor*.

$$k_c = \frac{\text{voltage generated in the coil of span } \overline{AC}}{\text{voltage generated in the coil of span } \overline{AB}}$$

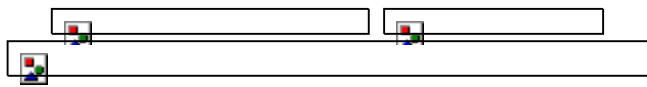

$$= \frac{AC}{2AB} = \frac{2AD}{2AB} = \cos \frac{\alpha}{2}$$

$$k_c = \cos \frac{\alpha}{2} \dots \dots \dots 1.12$$

For full-pitch coil,  $\alpha=0$ , so,  $\cos \frac{\alpha}{2} = 1$  and  $k_c = 1$ . For a short-pitch coil  $k_c < 1$ .

**Advantages of short pitching or chording**

1. Shortens the ends of the winding and therefore there is a saving in the conductor material.
2. Reduces the effects of distorting harmonics, and thus the wave form of the generated voltage is improved and making it approach a sine wave.

**DISTRIBUTION FACTOR OR BREADTH FACTOR  $k_d$**

In a concentrated winding, the coil sides of a given phase are concentrated in a single slot under a given pole. The individual coil voltages induced are in phase with each

other. These voltages may be added arithmetically. In order to determine the induced voltages

induced per phase, a given coil voltage is multiplied by the number of series –connected coils per phase. In actual practice, in each phase, coils are not concentrated in a single slot, but are distributed in a number of slots in space to form a polar group under each pole. The voltages induced in coil-sides constituting a polar group are not in phase but differ by an angle equal to the angular displacement  $\beta$  of the slots. The total voltage induced in any phase will be the phasor sum of the individual coil voltages.

The distribution factor or breadth factor is defined as the ratio of the actual voltage obtained to the possible voltage if all the coils of a polar group were concentrated in a single slot.

$$k_d = \frac{\text{Phasor sum of coil voltages per phase}}{\text{arithmetic sum of coil voltages per phase}} \dots\dots\dots 1.13$$

Let m = the slots per pole per phase ,that is slots per phase belt

$$m = \frac{\text{slots}}{\text{Poles} \times \text{Phases}} \dots\dots\dots 1.14$$

$\beta$  = Angular displacement between adjacent slots in electrical degrees

$$\beta = \frac{\text{slots/pole}}{\text{slots}} \dots\dots\dots 1.15$$

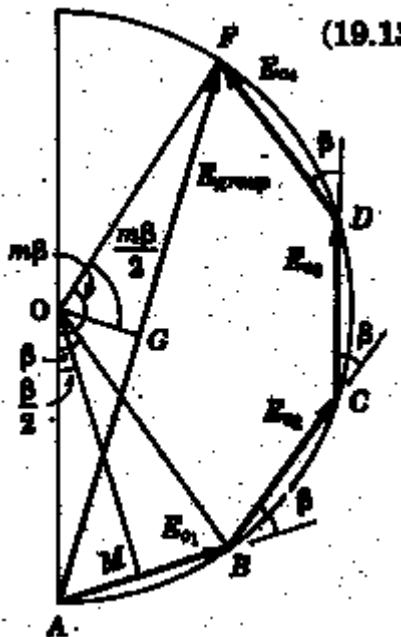

Fig. 1.7

Thus, one phase of the winding consists of coils arranged in m consecutive slots. Voltage  $E_{c1}, E_{c2} \& E_{c3}, \dots$  are the individual coil voltages. Each coil voltage  $E_c$  will be out of phase with the next coil voltage by the slot pitch  $\beta$ . Figure 1.7 shows the voltage polygon of the induced voltages in the four coils of a group (m=4). The voltages  $E_{c1}, E_{c2}, E_{c3}$ , and  $E_{c4}$  are represented by phasors AB, BC, CD and DF respectively in figure 1.7. Each of these phasors is a chord of a circle with center o and subtends an angle  $\beta$  at O. The phasor sum AF, representing the resultant winding voltage, subtends an angle  $m\beta$  at the center.

Arithmetic sum of individual coil voltages

$$= m E_c = m AB = m (2AM)$$

$$= 2m \sin Aom = 2m OA \sin \frac{\beta}{2}$$

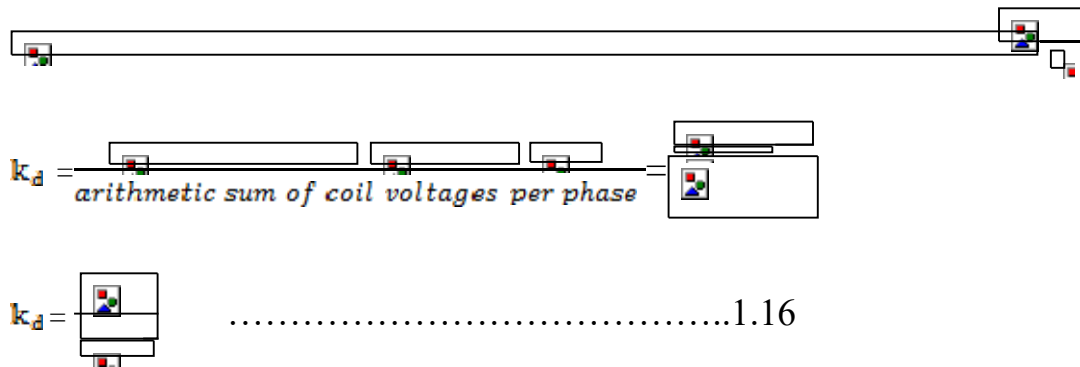

It is to be noted that the distribution factor  $k_d$  for a given number of phases is dependent only on the number of distributed slots under a given pole. It is independent of the type of the winding, Lap or wave, or the number of coil, etc. As the number of slots per pole increases the distribution factor decreases.

### ACTUAL VOLTAGE GENERATED

Taking the coil span factor and the distribution factor into account, the actual generated voltage per phase is given by  $E_p = 4.44 K_c K_d f \Phi T_p$

..... 1.17

Equation (1.17) is called the complete emf equation of an alternator.

The quantity  $(K_c K_d T_p)$  is sometimes called effective turns per phase  $T_{ep}$ .

$$T_{ep} = K_c K_d T_p \dots\dots\dots 1.18$$

It is smaller than the actual number of turns per phase due to fractional pitch coils and due to distribution of winding over several slots under each pole.

The coil span factor and distribution factor of a winding are sometimes combined into a single winding factor  $K_w$ , which is the product of  $K_c$  and  $K_d$ . That is

$$K_w = K_c K_d \dots\dots\dots 1.19$$

For a star connected alternator, the line voltage is  $\sqrt{3}$  times the phase voltage.

$$E_L = \sqrt{3} E_{ph}$$

Alternative terms for the voltage E are

Open circuit voltage per phase

No-Load voltage per phase

Excitation voltage per phase

Internal voltage per phase

Voltage behind synchronous reactance per phase

The angle between the terminal voltage V and the internal voltage E is the machine angle or rotor angle  $\delta$ .

**Example 1.2**

A 3-phase, 50 Hz, 8-pole alternator has a star-connected winding with 120 slots and 8 conductors per slot. The flux per pole is 0.05 Wb, sinusoidally distributed. Determine the phase and line voltages.

Solution :

Let us take the full-pitch coil,

So,  $\alpha = 0^\circ$ ,  $K_c = \frac{\text{Diagram}}{\text{Diagram}} = \cos 0^\circ = 1$



$$m = \frac{\text{slots}}{\text{Poles} \times \text{Phase}} = \frac{\text{Diagram}}{8 \times 3} = 50 \text{ Hz}$$

$$\beta = \frac{\text{conductors per slot} \times \text{slots}}{\text{conductors per slot}} = \frac{8 \times 12}{8} = 12$$

$$K_d = \frac{\text{conductors per slot} \times \text{slots}}{\text{conductors per slot}} = 0.9567$$

Total number of conductors = conductors per slot X number of slots = 8 x 120 = 960

$$\text{Conductors per phase} = Z_p = \frac{960}{3}$$

$$\text{Generated voltage per phase} = E_p = 2.22 K_c K_d f \Phi Z_p$$

$$= 2.22 \times 1 \times 0.9567 \times 50 \times 0.05 \times 320 = 1699 \text{ volts}$$

$$\text{Generated Line voltage} = E_L = \sqrt{3} E_{ph} = \sqrt{3} \times 1699 = 2942.8 \text{ volts.}$$

## ARMATURE LEAKAGE REACTANCE

In an ac machine, any flux set up by the load current which does not contribute to the useful flux of the machine is a leakage flux. The effect of this leakage flux is to set up a self-induced emf in the armature windings.

The leakage fluxes may be classified as follows :

1. Slot leakage
2. Tooth head leakage
3. Coil-end or over-hang leakage

The voltages induced in the armature windings by the air-gap flux is called the air-gap voltages.

The leakage fluxes also induce voltages in the armature windings. These are taken into account by introduction of leakage reactance drops. Most of the reluctances of the magnetic circuits for armature leakage fluxes are due to air paths. The fluxes are therefore nearly proportional to the armature currents producing them and are in phase with these currents. For this reason, the voltages they induce in the armature windings can be taken into account by the use of constant leakage reactances for the phases, which multiplied by the phase currents, give the component voltages induced in the phases of the leakage flux. These voltages are the leakage reactance drops and lead the currents producing them by  $90^\circ$ .

## ARMATURE REACTION

When load current flows through the armature windings of an alternator, the resulting mmf produces flux. This armature flux reacts with the main-pole flux, causing the resultant flux to become either less than or more than the original main flux. The effect of the armature(stator) flux on the flux produced by the rotor field poles is called **armature reaction**. The armature reaction flux is constant in magnitude and rotates at synchronous speed. The armature reaction depends upon the power factor of the load. If the armature reaction flux is assumed to act independently of the main field flux, it induces a voltage in each phase which lag the respective phase currents by  $90^\circ$ . It is to be noted that armature reaction effects are seen to be an essential part of the torque producing mechanism.

Two things are worth noting about the armature reaction in an alternator. First, the armature flux and the flux produced by rotor ampere-turns rotate at the same speed (synchronous speed) in the same direction and, therefore, the two fluxes are fixed in space relative to each other. Secondly, the modification of flux in the air-gap due to armature flux depends on the magnitude of stator current and on the power factor of the load. It is the load power factor which determines whether the armature flux distorts, opposes or helps the flux produced by rotor ampere-turns. To illustrate this important point, the following three cases may be considered :

- (i) When load p.f. is unity
- (ii) When load p.f. is zero lagging
- (iii) When load p.f. is zero leading

**When load p.f. is unity** : Figure 1.7.1(i) shows an elementary alternator on no-load. since the armature is on open-circuit, there is no stator current in the flux due to rotor current is distributed symmetrically in the air-gap as shown in fig.1.7.1(i). Since the direction of the rotor is assumed clockwise, the generated e.m.f in phase  $R_1R_2$  is at its maximum and is towards the paper in the conductor  $R_1$  and outwards in conductor  $R_2$ . No armature flux is produced since no current flows in the armature winding.

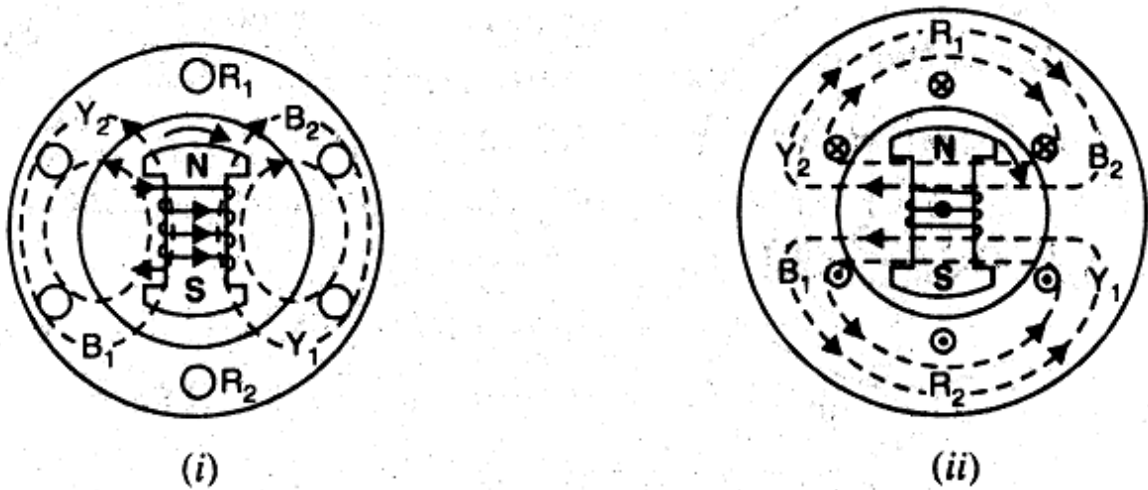

Fig.1.7.1

Fig.1.7.1(ii) shows the effect when a resistive load (unity p.f.) is connected across the terminals of the alternator. According to right-hand rule, the current is inwards in the conductors under N-pole and outwards in the conductors under S-pole. Therefore, the armature flux is clockwise due to currents in the top conductors and anticlockwise due to current in the bottom conductors. Note that armature flux is at  $90^\circ$  to the main flux (due to rotor current) and is behind the main flux. In this case, the flux in the air-gap is distorted but not weakened. Therefore, at unity p.f., the effect of armature reaction is merely to distort the main field; there is no weakening of the main field and the average flux practically remains the same. Since the magnetic flux due to stator currents (i.e. armature flux) rotates synchronously with the rotor, the flux distortion remains the same for all positions of the rotor.

**When load p.f. is zero lagging :**

when a pure inductive load (zero p.f. lagging) is connected across the terminals of the alternator, current lags behind the voltage by  $90^\circ$ . This means that current will be maximum at zero e.m.f. and vice-versa.

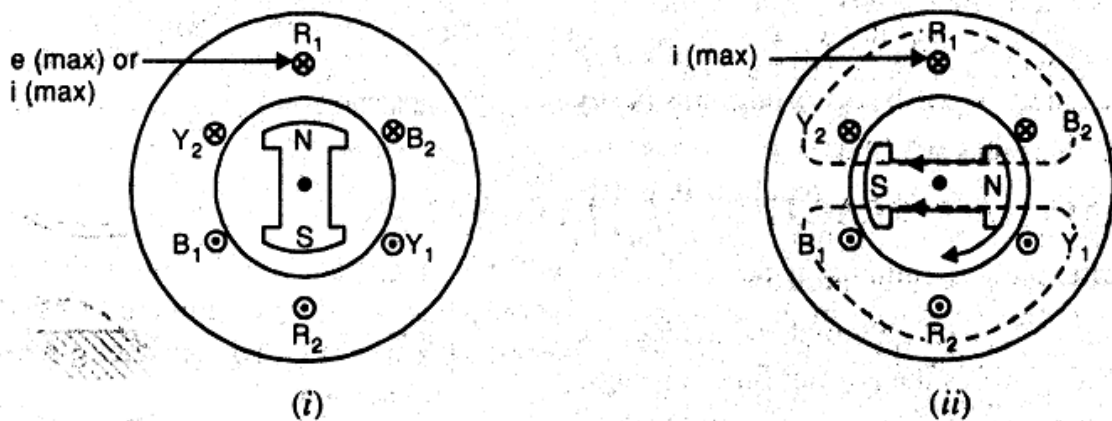



Fig.1.7.2

Fig.1.7.2(i) shows the condition when the alternator is supplying resistive load. Note that e.m.f. as well as current in phase  $R_1R_2$  is maximum in the position shown. When the alternator is supplying a pure inductive load, the current in phase  $R_1R_2$  will not reach its maximum value until N-pole advanced  $90^\circ$  electrical as shown in fig.1.7.2(ii). Now the armature flux is from right to left and field flux is from left to right. All the flux produced by armature current (i.e., armature flux) opposes the field flux and, therefore, weakens it. In other words, armature reaction is directly de-magnetising. Hence, at zero p.f. lagging, the armature reaction weakens the main flux. This causes a reduction in the generated e.m.f..

### When load p.f. is zero leading :

when a pure capacitive load (zero p.f. leading) is connected across the terminals of the alternator, the current in armature windings will lead the induced e.m.f. by  $90^\circ$ . Obviously, the effect of armature reaction will be the reverse that for pure inductive load. Thus, armature flux now aids the main flux and the generated e.m.f. is increased.

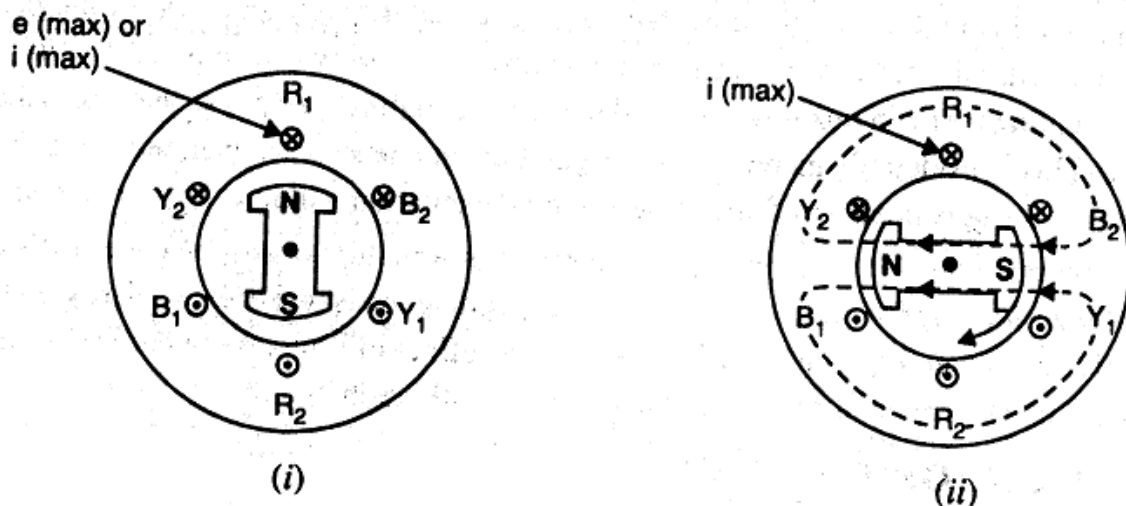

Fig.1.7.3

Fig.1.7.3(i) shows the condition when the alternator is supplying resistive load. Note that e.m.f. as well as current in phase  $R_1R_2$  is maximum in the position shown. When the alternator is supplying a pure capacitive load, maximum current in phase  $R_1R_2$  will occur

$90^\circ$  electrical before the occurrence of maximum induced e.m.f. Therefore, maximum current in phase  $R_1R_2$  will occur if the position of the rotor remains  $90^\circ$  behind as compared to its position under resistive load. This is illustrated in fig.1.7.3(ii). It is clear that armature flux is now in the same direction as the field flux and therefore, strengthens it. This causes an increase in the generated voltage. Hence at zero p.f. leading, the armature reaction strengthens the main flux.

For intermediate values of p.f., the effect of armature reaction is partly distorting and partly weakening for inductive loads. For capacitive loads, the effect of armature reaction is partly distorting and partly strengthening. Note that in practice, loads are generally inductive.

Summary :

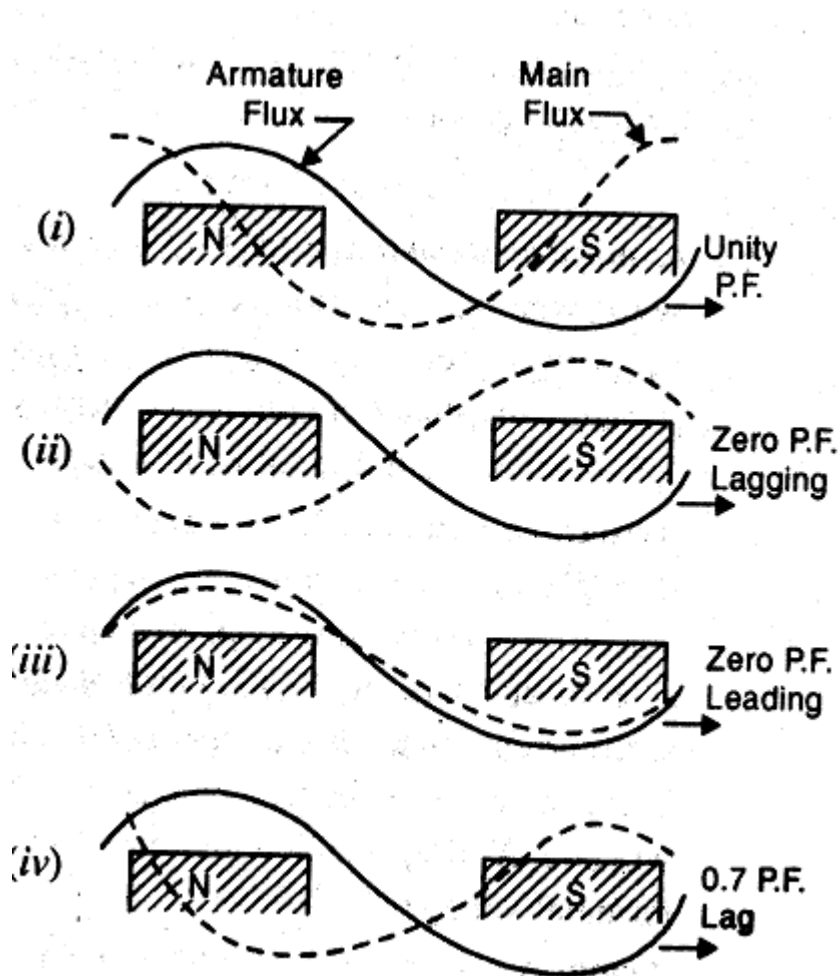

Fig.1.7.4

When the alternator is loaded, the armature flux modifies the air-gap flux .Its angle(electrical) with respect to main flux depends on the load p.f..This is illustrated in Fig.1.7.4.

- (a) **When the load p.f. is unity** : the effect of armature reaction is wholly distorting. In other words, the flux in the air-gap is distorted but not weakened. As shown in Fig.1.7.4(i), the armature flux is  $90^\circ$  electrical behind the main flux. The result is that flux is strengthened at the trailing pole tips and weakened at the leading pole tips. However, the average flux in the air-gap practically remains unaltered.
- (b) **When the load p.f. is zero lagging** : the effect of armature reaction is wholly demagnetising. In other words ,the flux in the air-gap is weakened. As shown in Fig.1.7.4(ii),the wave representing the main flux is moved backwards through  $90^\circ$  electrical so that it is in direct opposition to the armature flux. This considerably reduces the air-gap flux and hence the generated e.m.f..To keep the value of the generated e.m.f. the same,the field excitation will have to be increased to compensate for the weakening of the air-gap flux.
- (c) **When the load p.f. is zero leading**: the effect of armature reaction is wholly magnetising. In other words ,the flux in the air-gap is increased. As shown in Fig.1.7.4(iii),the wave representing the main flux is now moved forward through  $90^\circ$  electrical so that it aids the armature flux. This considerably increases the air-gap flux and hence the generated e.m.f.. To keep the value of the generated e.m.f. the same,the field excitation will have to be reduced .
- (d) **For intermediate values of load p.f.:** the effect of armature reaction is partly distorting and partly weakening for inductive loads. For capacitive loads, the effect is partly distorting and partly strengthening .Fig.1.7.4(iv) shows the effect of armature reaction for an inductive load. In practice, load on the alternator is generally inductive.

For the intermediate values of p.f. , the effect of armature reaction is partly distorting and partly weakening for inductive loads.For capacitive loads the effect of armature reaction is partly distorting and partly strengthening. Note that in practice, the loads are generally inductive.

## SYNCHRONOUS IMPEDANCE

The actual generated voltage consists of the summation of two component voltages. One of these component voltages is the voltage that would be generated if there were no armature reaction. It is the voltage that would be generated because of only the field excitation. This component of the generated voltage is called the excitation voltage,  $E_{exc}$ .

The other component of the generated voltage is called the armature reaction voltage,  $E_{AR}$ . This is the voltage that must be added to the excitation voltage to take care of the effect of armature reaction upon the generated voltage

$$E_a = E_{exc} + E_{AR} \dots\dots\dots 1.20$$

Since armature reaction results, in a voltage effect in a circuit caused by change in flux by current in the same circuit ,its effect is of the nature of an inductive reactance .Therefore,  $E_{AR}$  is equivalent to a voltage of inductive reactance and

$$E_{AR} = -j X_{AR} I_a \dots\dots\dots 1.21$$

The inductive reactance  $X_{AR}$  is a fictitious reactance which will result in a voltage in the armature circuit to account for the effect of armature reaction upon the voltage relations of the armature circuit. Therefore, armature reaction voltage can be modeled as an inductor in series with the internal generated voltage.

In addition to the effects of armature reaction, the stator winding also has a self-inductance and a resistance.

Let  $L_a$  = Self-inductance of stator winding

$X_a$  = Self-inductive reactance of stator winding

$R_a$ =Armature (stator) resistance

The terminal voltage V is given by

$$V = E_a - jI_a X_{AR} - jI_a X_a - I_a R_a$$

Where  $I_a R_a$  = armature resistance drop

$I_a X_a$  = armature leakage reactance drop

$I_a X_{AR}$  = armature reaction voltage

The armature reaction effects and the leakage flux effects in the machine are both represented by inductive reactances . Therefore, it is customary to combine them in to a single reactance, called the synchronous reactance of the machine,  $X_s$ .

$$X_s = X_{AR} + X_a \dots\dots\dots 1.22$$

$$\therefore V = E_a - j X_s I_a - R_a I_a$$

$$\text{Or } V = E_a - (R_a + jX_s)I_a \dots\dots\dots 1.23$$

$$V = E_a - Z_s I_a \dots\dots\dots 1.24$$

$$\text{Where } Z_s = R_a + jX_s \dots\dots\dots 1.25$$

The impedance  $Z_s$  is called the *synchronous impedance*.

The synchronous reactance  $X_s$  is the fictitious reactance employed to account for the voltage effects in the armature circuit produced by the actual armature leakage reactance and by the change in air-gap flux caused by the armature reaction.

Similarly, the synchronous impedance  $Z_s$  is a fictitious impedance employed to account for the voltage effects in the armature circuit produced by the actual armature resistance, the actual armature leakage reactance and the change in air-gap flux caused by the armature reaction.

**EQUIVALENT CIRCUIT AND PHASOR DIAGRAMS OF A SYNCHRONOUS GENERATOR**

The equivalent reactance of a synchronous generator is shown in figure 1.8(a). It is redrawn in Fig.1.8(b) by taking

$$X_s = X_{AR} + X_a$$

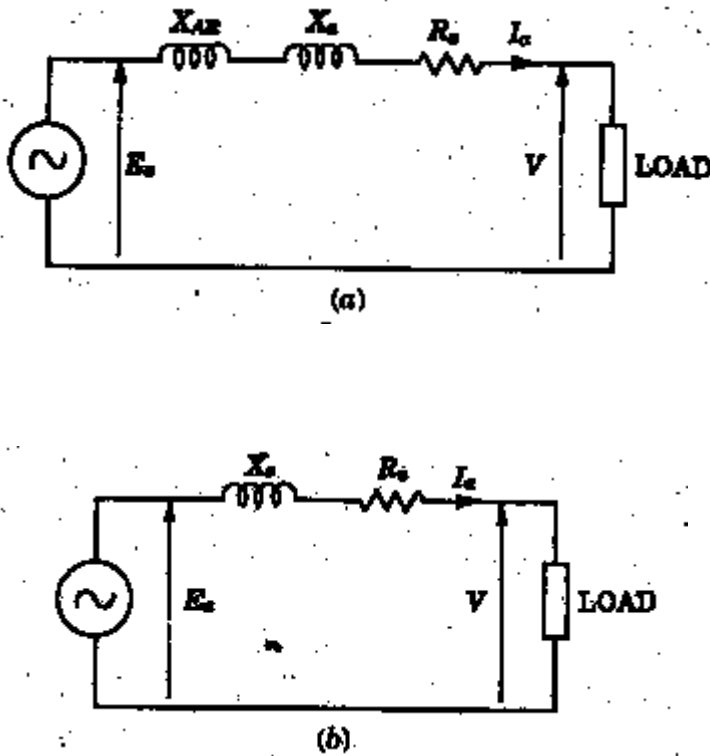

Fig.1.8 Equivalent circuit of a synchronous generator

a) Lagging power factor  $\cos \Phi$

Figure 1.9(a) shows the phasor diagram for lagging p.f. load. The power factor is  $\cos \Phi$  lagging. In this diagram the terminal voltage  $V$  is taken as reference phasor along  $OA$  such that  $OA = V$ . For lagging power factor  $\cos \Phi$ , the direction of armature current  $I_a$  lags behind the voltage  $V$  by an angle  $\Phi$  along  $OB$ , where  $OB = I_a$ . The voltage drop in the armature resistance is  $I_a R_a$ . It is represented by phasor  $AC$ . The voltage drop in the synchronous reactance is  $I_a X_s$ . It is represented by  $CD$ . It leads the current  $I_a$  by  $90^\circ$  and, therefore,  $CD$  is drawn in a direction perpendicular to  $OB$ . The total voltage drop in the synchronous impedance is the phasor sum of  $I_a R_a$  &  $I_a X_s$ . It is represented by  $AD$ . The phasor  $OD$  represents  $E_a$ .

The magnitude  $E_a$  can be found from the right-angled triangle  $OGD$

$$OD^2 = OG^2 + GD^2 = (OF + FG)^2 + (GC + CD)^2$$

$$E_a^2 = (V \cos \Phi + I_a R_a)^2 + (V \sin \Phi + I_a X_s)^2$$

$$E_a = \sqrt{(V \cos \Phi + I_a R_a)^2 + (V \sin \Phi + I_a X_s)^2}$$

.....1.26

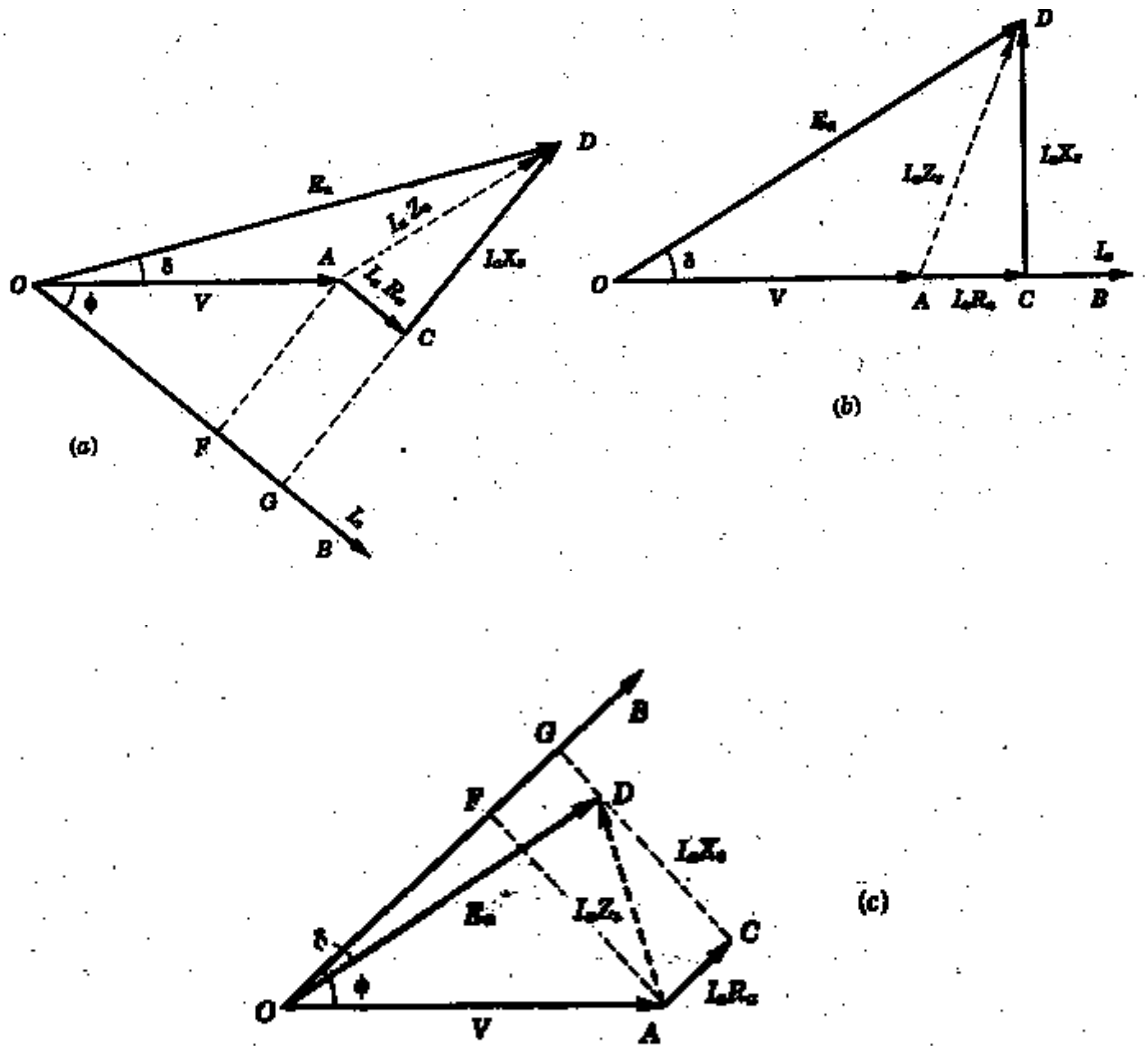

a) Phasor diagram for lagging power factor  $\cos \phi$  (b) Phasor diagram for unity power factor  
 (c) Phasor diagram for leading power factor  $\cos \phi$

Fig.1.9

**b) Unity power factor  $\cos \Phi$**

Figure 1.9(b) shows the phasor diagram for unity power factor load.

From the right-angled triangle OCD

$$OD^2 = OC^2 + CD^2 = (OA + AC)^2 + (CD)^2$$

$$E_a^2 = (V + I_a R_a)^2 + (I_a X_s)^2$$

$$E_a = \sqrt{(V + I_a R_a)^2 + (I_a X_s)^2} \dots\dots\dots 1.27$$

**c) Leading power factor  $\cos \Phi$**

Figure 1.9(c) shows the phasor diagram for leading power factor load.

From the right-angled triangle OGD

$$OD^2 = OG^2 + GD^2 = (OF + FG)^2 + (GC - CD)^2$$

$$E_a^2 = (V \cos\phi + I_a R_a)^2 + (V \sin\phi - I_a X_s)^2$$

$$E_a = \sqrt{(V \cos\phi + I_a R_a)^2 + (V \sin\phi - I_a X_s)^2}$$

.....1.28

The angle  $\delta$  between  $E_a$  & V is called the **power angle** or **Torque angle** of the machine. It varies with load and is a measure of air-gap power developed in the machine.

### VOLTAGE REGULATION

The voltage regulation of as synchronous generator is defined as the change in terminal voltage from no-load to full-load divided by the full-load voltage when the speed and field current remaining constant.

It is expressed as a fraction or a percentage of full-load terminal voltage .It can be written as

$$\text{Per unit voltage regulation} = \frac{E_0 - V}{V}$$

$$\text{Percentage voltage regulation} = \frac{E_0 - V}{V} \times 100$$

Where  $E_0$  = magnitude of generated voltage per phase

V = magnitude of rated terminal voltage per phase

The voltage regulation depends upon the power factor of the load. For unity and lagging power factors, there is always a voltage drop with the increase of load, but for a certain leading p.f. the full-load regulation is zero. In this case the terminal voltage is same for both full-load and no-load conditions. At lower leading power factors the voltage rises with the increase of load, and the regulation is negative.

### DETERMINATION OF VOLTAGE REGULATION

The KVA ratings of commercial alternators are very high.(Example 500MVA). It is neither convenient nor practicable to determine the voltage regulation by direct loading. There are several indirect methods of determining the voltage regulation of an alternator. These



methods require only a small amount of power as compared to the power required for a direct loading method.

Three such methods are

- (i) Synchronous impedance method
- (ii) Ampere-Turn method
- (iii) Zero power factor or Potier method

For the synchronous impedance method the following tests are conducted .

### MEASUREMENT OF SYNCHRONOUS IMPEDANCE

The following tests are performed on an alternator to know its performance.

- a) DC resistance test
- b) Open-circuit test
- c) Short-circuit Test

#### DC RESISTANCE TEST

Assume that the alternator is star connected with d.c. field winding open(Fig. 1.10) , measure the d.c. resistance between each pair of terminals either by using ammeter-voltmeter method or by using Wheat stone's bridge. The average of three sets of resistance values  $R_t$  is taken. This value of  $R_t$  is divided by 2 to get the d.c. resistance(ohmic resistance) per phase. The alternator should be at rest. Since the effective a.c. resistance is larger than d.c. resistance due to skin effect, therefore, effective a.c. resistance per phase is obtained by multiplying the d.c. resistance by a factor of 1.2 to 1.75 depending on the size of the machine.

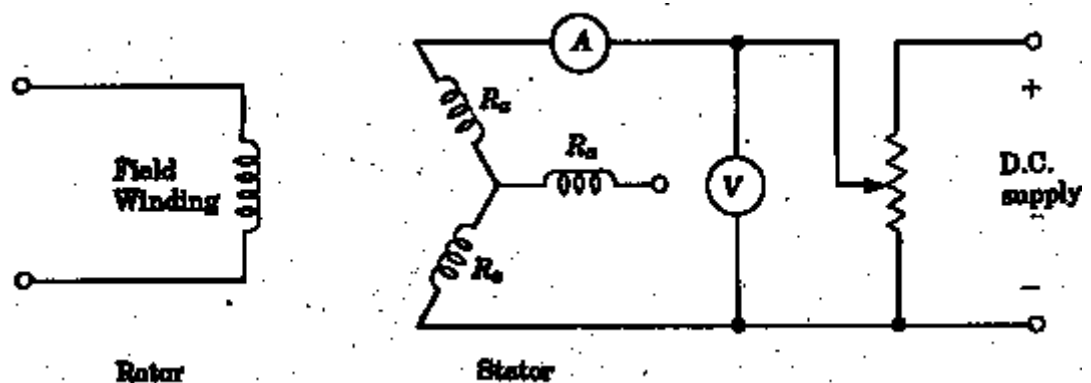

Fig.1.10 D.C. resistance test on an alternator.

#### Open –circuit Test

The alternator is run at rated synchronous speed and the load terminals are kept open Fig.1.11. That is, all the loads are disconnected. The field current is set to zero.

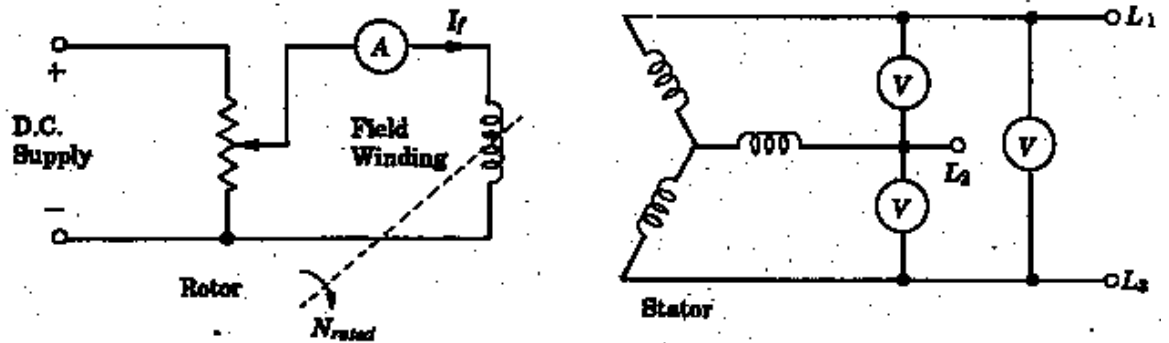

Fig.1.11 Open-circuit test on an alternator.

Then the field current is gradually increased in steps, and the terminal voltage  $E_t$  is measured at each step. The excitation current may be increased to get 25% more than rated voltage of the alternator. A graph is plotted between the open-circuit phase voltage  $E_p$  ( $= E_t / \sqrt{3}$ ) and field current  $I_f$ . The characteristics curve so obtained is called open-circuit characteristics (O.C.C.). It takes the shape of a normal magnetization curve. The extension of the linear portion of an O.C.C. is called the air-gap line of the characteristics. The O.C.C. and the air-gap line are shown in figure 1.12.

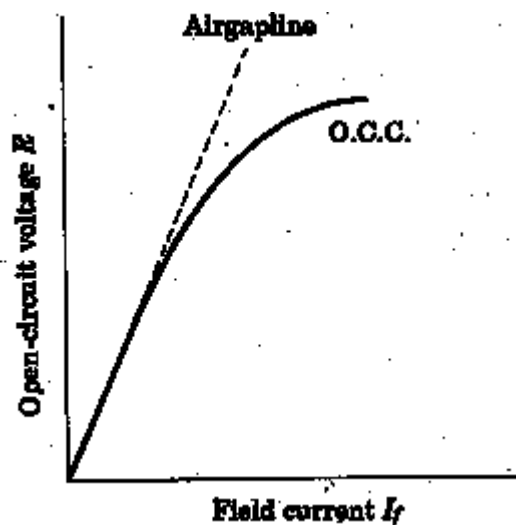

Fig.1.12 The O.C.C. of an alternator

### Short-Circuit Test

The armature terminals are shorted through three ammeters (Fig. 1.13). Care should be taken in performing this test, and the field current should first be decreased to zero before starting the alternator. Each ammeter should have a range greater than the rated full-load value. The alternator is then run at synchronous speed. Then the field current is gradually increased in steps, and the armature current is measured at each step. The field current may be increased to get armature currents upto 150% of the rated value. The field current  $I_f$  and the average of three ammeter readings at each step is taken. A graph is plotted between the armature current  $I_a$  and the field current  $I_f$ . The characteristics so obtained is called *short-circuit characteristics* (SCC). This characteristic is a straight line as shown in figure 1.14.

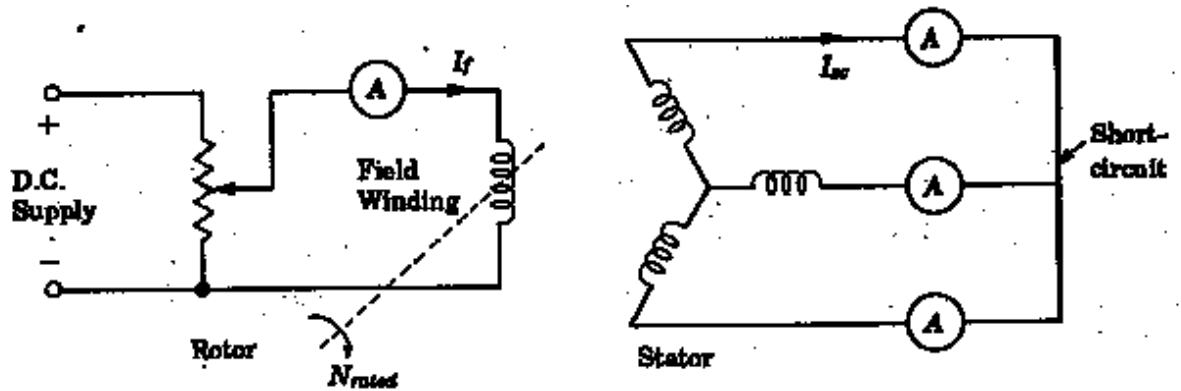

Fig.1.13

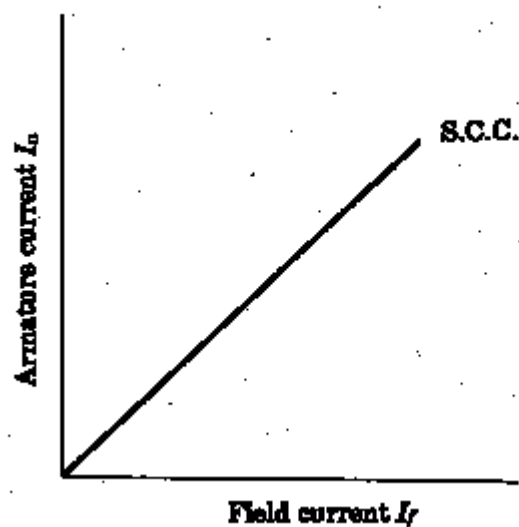

Fig.1.14. The S.C.C of an alternator

## Calculation of $Z_s$

The open-circuit characteristic (O.C.C.) and short-circuit characteristic (S.C.C) are drawn on the same curve sheet. Determine the value of  $I_{sc}$  at the field current that gives the rated alternator voltage per phase. The synchronous impedance  $Z_s$  will then be equal to the Open-Circuit voltage divided by the short circuit current at that field current which gives the rated e.m.f. per phase.

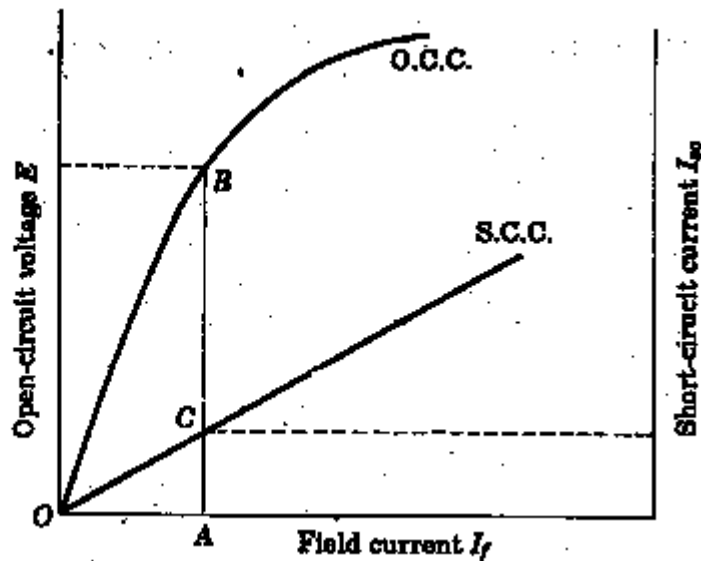

Fig.1.15

$$Z_s = \frac{\text{Open-circuit voltage } E}{\text{short-circuit armature current}} \text{ for the same value of field current.}$$

Now, knowing the Synchronous impedance and Armature resistance we can find out the Synchronous reactance

$$\text{synchronous reactance } X_s = \sqrt{Z_s^2 - R_a^2}$$

Once we know  $R_a$  and  $X_s$ , the phasor diagram can be drawn for any load and any P.F.. Fig 1.16. shows the phasor diagram for the usual case of inductive load ; the load power factor being  $\cos \phi$  lagging. Note that in drawing the phasor diagram, current  $I_a$  has been taken as the reference phasor. The  $I_a R_a$  drop is in phase with  $I_a$  while  $I_a X_s$  drop leads  $I_a$  by  $90^\circ$ . The phasor sum of  $V$ ,  $I_a R_a$  and  $I_a X_s$  gives the no-load e.m.f.  $E_0$

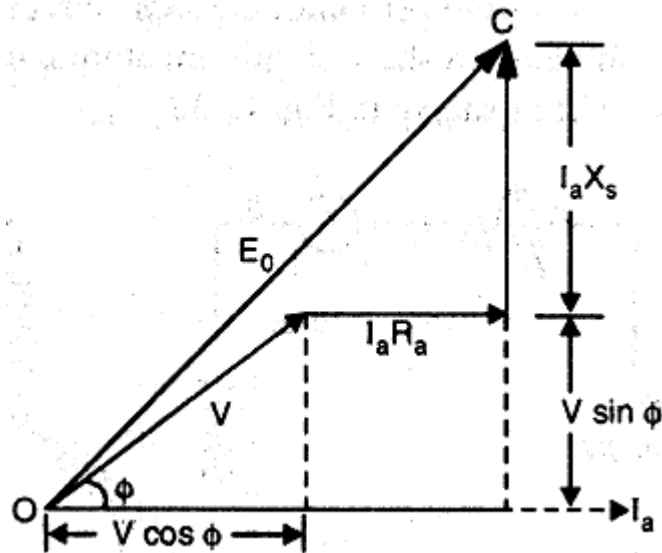

Fig.1.16

Now,

$$E_0 = \sqrt{(OB)^2 + (BC)^2}$$

$$OB = V \cos \phi + I_a R_a \text{ and } BC = V \sin \phi + I_a X_s$$

$$\therefore E_0 = \sqrt{(V \cos \phi + I_a R_a)^2 + (V \sin \phi + I_a X_s)^2}$$

$$\therefore \% \text{ voltage regulation} = \frac{E_0 - V}{V} \times 100$$

**Drawback :** This method is easy but it gives approximate results .The reason is simple. The combined effect of  $X_L$ (armature leakage reactance) and  $X_{AR}$ (reactance of armature reaction ) is measured on short-circuit.Since the current in this condition is almost lagging  $90^\circ$  ,the armature reaction will provide its worst demagnetizing effect. It follows that under any normal operation at,say 0.8 or 0.9 lagging power factors will produce error in calculations. This method gives a value higher than the value obtained from an actual load test.For this reason, it is called *pessimistic method*.

**Example 1.3**

A 500 v , 50 kVA single-phase alternator has an effective armature resistance of 0.2  $\Omega$  . An excitation current of 10 A produces 200 A armature current on short-circuit and an e.m.f. of 450 volt on open circuit. Calculate the synchronous reactance.

Solution :

$$Z_s = \frac{450}{\text{short-circuit armature current}} = \frac{450}{200} = 2.25 \Omega$$

$$X_s = \sqrt{Z_s^2 - R_a^2} = \sqrt{2.25^2 - 0.2^2} = 2.241 \Omega$$

**Example 1.4**

A 3-phase 2300 V ,50 Hz,1500 kVA star-connected alternator has a resistance between each pair of terminals as measured by direct current is 0.16  $\Omega$ . Assume that the effective resistance is 1.5 times the ohmic resistance. A field current of 70A produces a short-circuit current equal to full-load current of 376 A in each line. The same field current produces an e.m.f. of 700 volt on open circuit. Calculate the synchronous reactance of the machine and its full-load regulation at 0.8 power factor Lagging

Solution :

$$Z_s = \frac{700}{\text{short-circuit armature current}} = \frac{700}{376} = 1.075 \Omega$$

$$\text{Ohmic resistance per phase} = \frac{0.16}{2} = 0.08 \Omega$$

$$\text{Effective resistance per phase} = R_a = 1.5 \times 0.08 = 0.12 \Omega$$

$$\text{Synchronous reactance} = X_s = \sqrt{Z_s^2 - R_a^2} = \sqrt{1.075^2 - 0.12^2} = 1.068 \Omega$$

$$S_{3\phi} = \sqrt{3} V_L I_L ; \Rightarrow 1500 \times 10^3 = \sqrt{3} \times 2300 I_L ; I_L = 376 \text{ A}$$

$$\text{Rated voltage per phase} = V_p = \frac{2300}{\sqrt{3}} = 1328 \text{ V}$$

$$\text{Phase current } I_{ap} = I_L = 376 \text{ A}$$

$$E_p = V_p + I_{ap} Z_s$$

Let  $V_p$  taken as reference phasor :

$$V_p = V_{pL} 0^0 = 1328 L 0^0 \text{ volts} = 1328 + j 0 \text{ volts}$$

$$I_{ap} = I_{apL} \cos^{-1} 0.8 = 376 L -36.87^0 \text{ A}$$

$$Z_s = R_s + jX_s = 0.12 + j 1.068 = 1.075 L 83.59^0 \Omega$$

$$E_p = 1328 + j 0 + (376 L -36.87^0)(1.075 L 83.59^0) = 1328 + 404.2 L 46.72^0$$

$$= 1328 + 277.1 + j 294.26 = 1605.1 + j 294.26 = 1631 L 10.39^0 \text{ volt}$$

$$\text{Percentage Regulation} = \frac{E_p - V_p}{V_p} \times 100 = 22.8 \%$$

### AMPERE-TURN METHOD

This method of finding voltage regulation considers the opposite view to the synchronous impedance method. It assumes the *armature leakage reactance to be additional armature reaction*. Neglecting armature resistance (always small), this method assumes that change in terminal p.d. on load is due entirely to armature reaction. The same two tests (Open and short circuit test) are required as for synchronous reactance determination; the interpretation of the results only is different. Under short-circuit, the current lags by  $90^0$  ( $R_a$  considered zero) and the power factor is zero. Hence, the armature reaction is entirely demagnetizing. Since, the terminal p.d. is zero, all the field AT (ampere-turns) are neutralized by armature AT produced by the short circuit armature current.

- (i) Suppose the alternator is supplying full-load current at normal voltage  $V$  (i.e., operating load voltage) and zero p.f. lagging. Then d.c. field AT required will be those needed to produce normal voltage  $V$  (or if  $R_a$  is to be taken into account, then  $V + I_a R_a \cos \theta$ ) on no-load plus those to overcome the armature reaction.

Let  $AO$  = field AT required to produce the normal voltage  $V$  (or  $V + I_a R_a \cos \theta$ ) at no-load.

$OB_1$  = field AT required to neutralize the armature reaction

Then total field AT required are the phasor sum of  $AO + OB_1$  (Fig. 1.17(i))

total field AT,  $AB_1 = AO + OB_1$  ..... phasor sum

The AO can be found from O.C.C. and  $OB_1$  can be determined from S.C.C.. Note that the use of a d.c. quantity (field AT) as a phasor is perfectly valid in this case because the d.c. field is rotating at the same speed as the a.c. phasors i.e.  $\omega = 2\pi f$ .

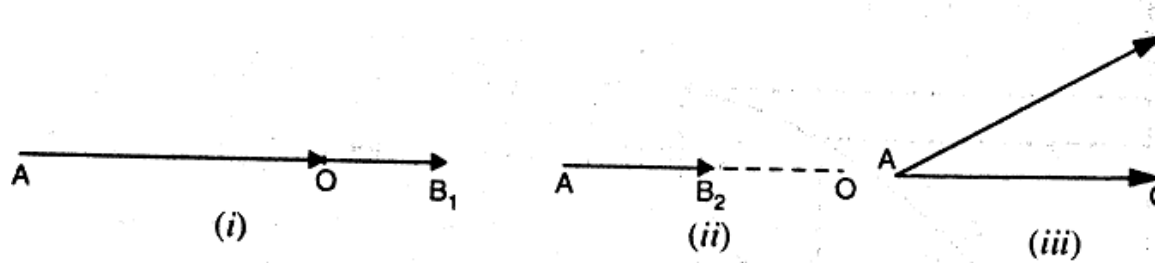

Fig 1.17

(ii) For a full-load current of zero p.f. leading, the armature AT are unchanged. Since they aid the main field, less field AT are required to produce the given e.m.f.

So, the total field AT,  $AB_2 = AO - B_2O$ .....phasor difference

Where  $B_2O$  =field AT required to neutralize armature reaction

This is illustrated in Fig 1.17(ii).Note that again AO is determined from O.C.C. and  $B_2O$  from S.C.C.

(iii) Between zero lagging and zero leading power factors, the armature m.m.f. rotates through  $180^\circ$ . At unity p.f. ,armature reaction is cross-magnetising only. Therefore,  $OB_3$  is drawn perpendicular to AO(Fig.1.17(iii)).Now  $AB_3$  shows the required AT in magnitude and direction.

General Case .

It may now be discussed the case when the pf has any value between zero (lagging or leading) and unity.If the power-factor is  $\cos \phi$  lagging, then  $\phi$  is laid off to the right of the vertical line  $OB_3$  as shown in Fig.1.18(i).The total field AT required are  $AB_4$  i.e.,phasor sum of AO and  $OB_4$ .If the power factor is  $\cos \phi$  leading , then  $\phi$  is laid off to the left of the vertical line  $OB_3$  as shown in Fig.1.18(ii).The total field AT required are  $AB_5$  i.e.,phasor sum of AO and  $OB_5$ .



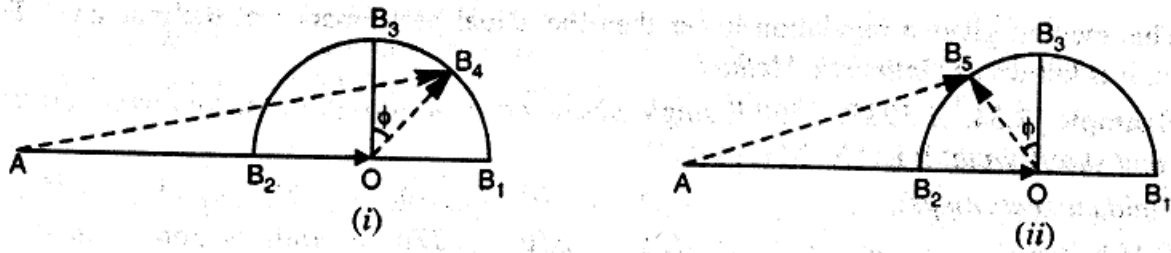

Fig 1.18

Since current  $\propto AT$ , it is more convenient to work in terms of field current. Fig. 1.19 shows the current diagram for the usual case for lagging power factor. Here AO represents the field current required to produce normal voltage  $V$  (or  $V + I_a R_a \cos\phi$ ) on no-load. The phasor OB represents the field current required for producing full-load current on short-circuit. The resultant field current is AB and the phasor sum of AO and OB. Note that phasor AB represents the field current required for demagnetizing an d to produce voltage  $V$  and  $I_a R_a \cos\phi$  drop. (if  $R_a$  is taken into account).

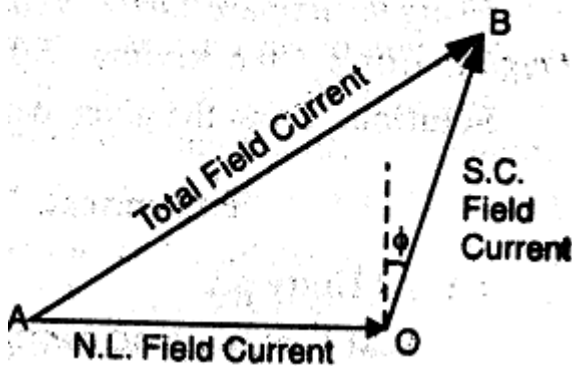

Fig.1.19

### PROCEDURE FOR AT METHOD

Suppose the alternator is supplying full-load current  $I_a$  at operating voltage  $V$  and p.f.  $\cos\phi$  lagging. The procedure for finding voltage regulation for AT method is as under :

- (i) From the O.C.C., field current OA required to produce the operating load voltage  $V$  (or  $V + I_a R_a \cos\phi$ ) is determined as shown in Fig.1.20. The field current OA is slid off horizontally as shown in Fig.1.21.

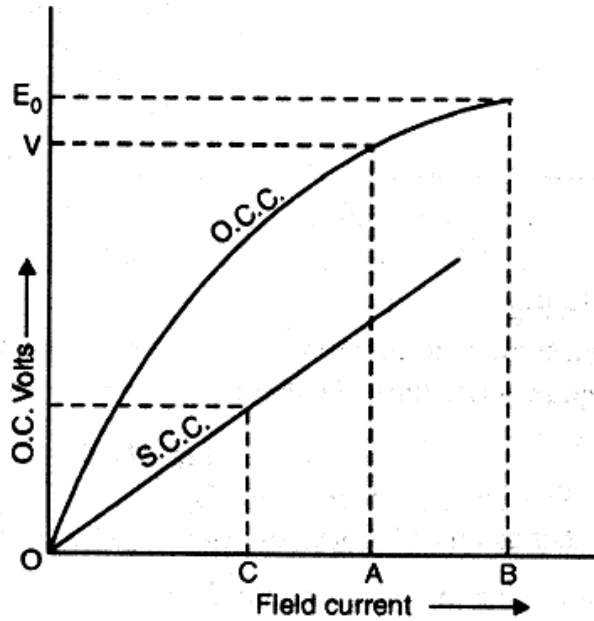

Fig.1.20

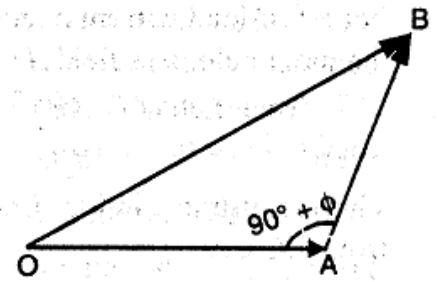

Fig.1.21

(ii) From S.C.C., the field current OC required for producing full-load current  $I_a$  on short-circuit is determined. The phasor AB(=OC) is drawn at an angle of  $(90^\circ + \phi)$  i.e.,  $\text{Arg}(OAB) = (90^\circ + \phi)$  as shown in Fig. 1.21.

(iii) The phasor sum of OA and AB gives the total field current OB required. The O.C. voltage  $E_0$  corresponding to field current OB on O.C.C. is the no-load e.m.f. voltage regulation =  $\frac{E_0 - V}{V} \times 100$

This method gives a regulation lower than the actual performance of the machine. For this reason, it is known as *Optimistic method*.

## ZERO POWER FACTOR METHOD OR POTIER METHOD

In this method, we separately determine the voltage drop due to armature leakage reactance ( $= I_a X_l$ ) and voltage drop due to armature reaction ( $= I_a X_{AR}$ ). Therefore, it gives more accurate results. The Potier method consists of the following steps:

### (i) Plotting O.C.C. :

The open-circuit characteristics (O.C.C.) of the alternator is plotted by conducting no-load test on the alternator as explained earlier. The lower part of O.C.C. is practically a straight line and when extended becomes the air-gap line. Therefore, air-gap line represents O.C.C. of the alternator if the reluctance of the iron portion of the magnetic circuit of the machine is neglected as compared to the reluctance of the air-gap.





field current necessary to overcome the demagnetising effect of armature reaction at full-load and is drawn parallel to the current phasor  $I_a$ . The phasor sum of  $i_{f1}$  &  $i_{f2}$  gives the total field current  $i_f$  required to produce  $E_0$ . The phasor  $E_0$  (=ON) lags behind  $i_f$  by  $90^\circ$ . Note that phasor MN represents the voltage drop  $I_a X_{AR}$  due to armature reaction.

$$\text{Percentage voltage regulation} = \frac{V_0 - V}{V} \times 100$$

## PROCEDURE FOR POTIER METHOD

For solving problems relating to Potier method, the following procedure is adopted:

- (i) Suppose the terminal voltage per phase is  $V$ .
- (ii) Find the armature leakage reactance drop ( $= I_a X_L$ ) from the potier triangle.
- (iii) Add  $I_a X_L$  (and  $I_a R_a$  if given) vectorially to  $V$  to get  $E$ .
- (iv) From the O.C.C, find the field current required to produce  $E$ . Let it be  $i_{f1}$ .
- (v) From the potier triangle, find the field current necessary for balancing armature reaction. Let it be  $i_{f2}$ .
- (vi) Find the phasor sum of  $i_{f1}$  &  $i_{f2}$  to get the resultant field current  $i_f$ .
- (vii) From the O.C.C., find the e.m.f. corresponding to field current  $i_f$ . This gives us  $E_0$ . Therefore, we can find the voltage regulation.

## LIMITATIONS OF POTIER METHOD

The Potier method has the following drawbacks :

- (a) The Potier triangle is based on the assumption that the armature leakage reactance is constant and the O.C.C. of the alternator is the same under load as it is under open-circuit conditions. However, this is not correct. Therefore, the value of armature leakage reactance determined by the potier triangle method is not absolutely accurate. In order to distinguish the value of leakage reactance thus determined from the absolutely correct value, the value of leakage

reactance determined by the potier triangle method is sometimes called potier leakage reactance.

(b) In the potier triangle method, some error is also introduced due to the fact that it is not possible to obtain exactly zero P.F. for the zero power factor load test.

(c) A greater amount of error is exhibited by machines of salient pole construction than the non-salient pole construction. Best results are obtained by determining the value of armature leakage reactance and the m.m.f. of armature reaction from a potier triangle located as high as possible on the test curves.

## PARALLEL OPERATION OF ALTERNATORS

It is rare to find a 3-phase alternator supplying its own load independently except under test conditions. In practice, a very large number of 3-phase alternators operate in parallel because the various power stations are interconnected through the national grid. Therefore, the output of any single alternator is small compared with the total inter-connected capacity. For example, the total capacity of the interconnected system may be over 40,000MW while the capacity of the biggest single alternator may be 500MW. For this reason, the performance of a single alternator is unlikely to affect appreciably the voltage and frequency of the whole system. An alternator connected to such a system is said to be connected to *infinite bus-bars*. The outstanding electrical characteristics of such bus-bars are that they are constant – voltage, constant-frequency bus-bars.

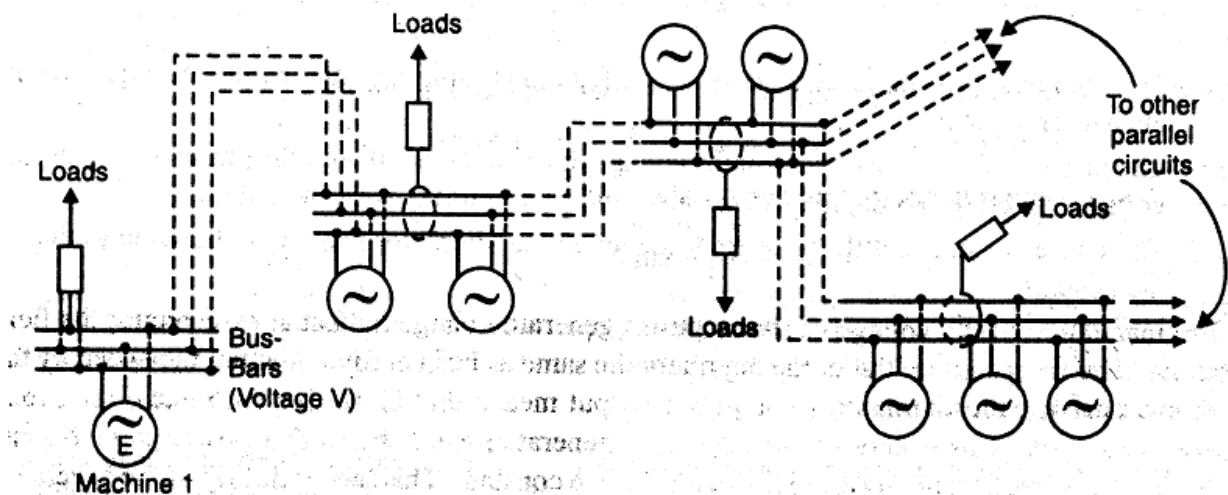

Fig.1.24

Fig. 1.24 Shows a typical infinite bus system .Loads are tapped from the infinite bus at various load centers. The alternators may be connected to or disconnected from the infinite bus, depending on the power demand on the system. If an alternator is connected to infinite bus-bars, no matter what power is delivered by the in-coming alternator, the voltage and the frequency of the system remain the same. The operation of connecting an alternator to the infinite bus-bars is known as parallel with the infinite bus-bars. It may be noted that before an alternator is connected to an infinite bus-bars, certain conditions must be satisfied.

### **ADVANTAGES of PARALLEL OPERATIONS OF ALTERNATORS**

The following are the advantages of operating alternators in parallel.

**(i) Continuity of service :** The continuity of service is one of the important requirements of any electrical apparatus. If one alternator fails, the continuity of supply can be maintained through the other healthy units. This will ensure un-interrupted supply to the consumers.

**(ii)Efficiency :**The load on the power system varies during the whole day ; being minimum during the late night hours. Since, alternators operate most efficiently when delivering full-load ,units can be added or put-off depending upon the load requirement. This permits the efficient operation of power system.

**(iii)Maintainance and Repair :** It is often desirable to carry out routine maintenance and repair of one or more units. For this purpose , the desired unit /units can be shut down and the continuity of supply is maintained through the other units.

**(iv)Load growth:** The load demand is increasing due to the increase in use of electrical energy. The load growth can be met by adding more units without disturbing the original installation .

### **CONDITIONS FOR PARALLELING ALTERNATOR WITH INFINITE BUSBARS**

The proper method of connecting an alternator to the infinite bus-bars is called synchronising. A stationary alternator must not be connected to live bus-bars. It is because the induced e.m.f. is zero at stand-still and a short-circuit will result .In order to connect an alternator safely to the infinite bus-bars , the following conditions are met.

- (i) The terminal voltage (r.m.s. value) of the incoming alternator must be the same as bus-bars voltage.
- (ii) The frequency of the generated voltage of the incoming alternator must be equal to the bus-bars frequency.

- (iii) The phase of the incoming alternator voltage must be identical with the phase of the bus-bars voltage. In other words, the two voltages must be in-phase with each other.
- (iv) The phase sequence of the voltage of the incoming alternator should be same as that of the bus-bars.

The magnitude of the voltage of the incoming alternator can be adjusted by changing its field excitation. The frequency of the incoming alternator can be changed by adjusting the speed of the prime-mover driving the alternator.

Condition(i) is indicated by a voltmeter, condition (ii) & (iii) are indicated by synchronizing lamps or a synchroscope. The condition (iv) is indicated by a phase sequence indicator.

### METHODS OF SYNCHRONISATION

The method of connecting an incoming alternator safely to the live busbars is called synchronising. The quality of voltage between the incoming alternators and the busbars can be easily checked by a voltmeter. The phase sequence of the alternator and the busbars can be checked by a phase sequence indicator. Differences in frequency and phase of the voltages of the incoming alternators and busbars can be checked by one of the following two methods.

1. **By three lamps(one dark,two bright) method.**
2. **By synchroscope**

**Three-Lamp method** : In this method of synchronising ,three lamps  $L_1, L_2$  and  $L_3$  are connected as shown in Fig.1.25. The lamp  $L_1$  is straight connected between the corresponding phases ( $R_1$  &  $R_2$ ) and the other two are cross-connected between the other two phases. Thus, lamp  $L_2$  is connected between  $Y_1$  &  $B_2$  and lamp  $L_3$  between  $B_1$  &  $Y_2$ . When the frequency & phase of the voltage of the incoming alternator is the same as that of the busbars, the straight connected lamp  $L_1$  will be dark while cross-connected lamp  $L_2$  &  $L_3$  will be equally bright. At this instant ,the synchronisation is perfect and the switch of the incoming alternator can be closed to connect it to the busbars. In Fig.1.25 Phasors  $R_1, Y_1$  &  $B_1$  represent the busbar voltages and phasors  $R_2, Y_2$  &  $B_2$  represent the voltages of the incoming alternator. At the instant when  $R_1$  is inphase with  $R_2$ , voltage across lamp  $L_1$  is zero and voltages across lamps



$L_2$  &  $L_3$  are equal. Therefore, lamp  $L_1$  is dark while lamps  $L_2$  &  $L_3$  will be equally bright. At this instant, the switch of the incoming alternator can be closed. Thus, incoming alternator gets connected in parallel with the busbars.

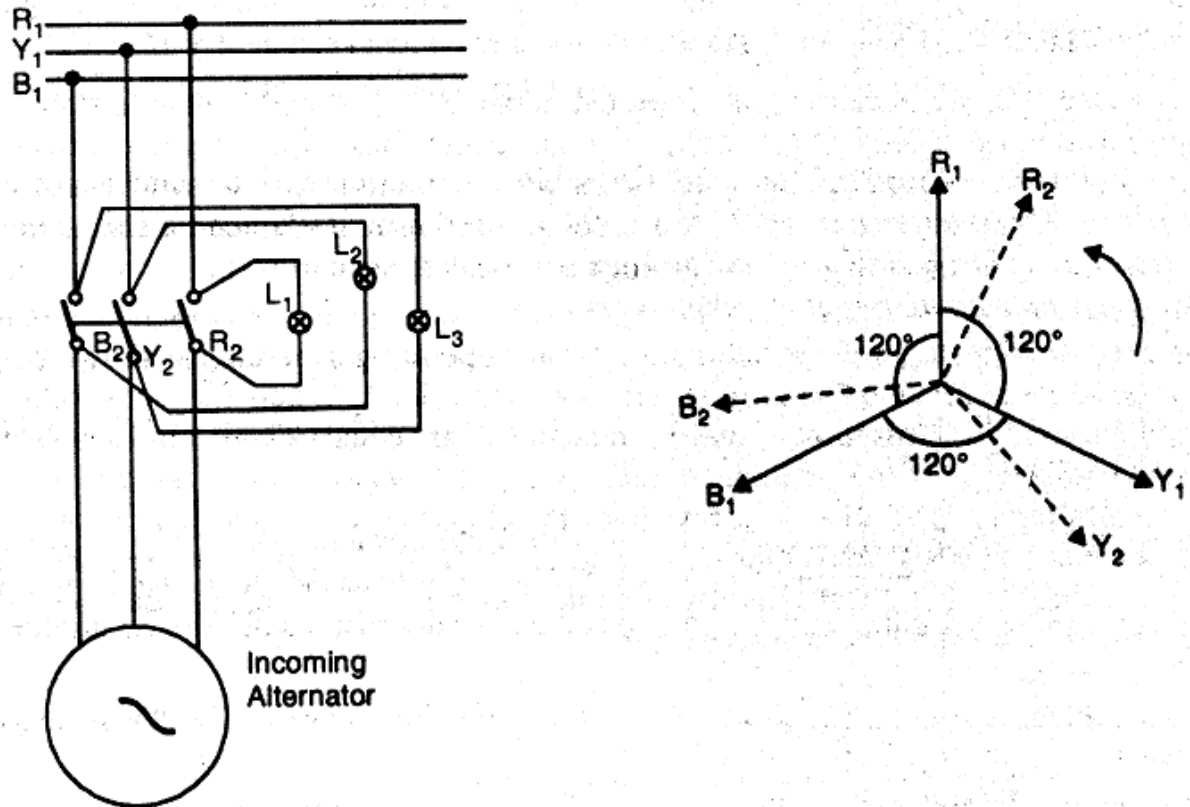

Fig.1.25

**Synchroscope** : A synchroscope is an instrument that indicates by means of a revolving pointer the phase difference and the frequency difference between the voltages of the incoming alternator and the busbars (Fig. 1.26). It is essentially a small motor, the field being supplied from the busbars through a potential transformer and the rotor from the incoming alternator. Pointer is attached to the rotor. When the incoming alternator is running fast, (i.e. the frequency of the incoming alternator is higher than that of the busbars), the rotor and hence pointer moves in the clock-wise direction. When the incoming alternator is running slow that is, (frequency of the incoming alternator is lower than that of the busbars), the pointer moves in anti-clockwise direction. When the frequency of the incoming alternator is equal to that of the busbars, no torque acts on the rotor and the pointer points vertically upwards ("12 O' Clock"). It indicates the correct instant for connecting the incoming alternator to the busbars. The synchroscope method is superior to the Lamp method because it not only gives a positive indication of the time to close the switch but also indicates the adjustments to be made

should there be a difference between the frequencies of the incoming alternator and the busbars.

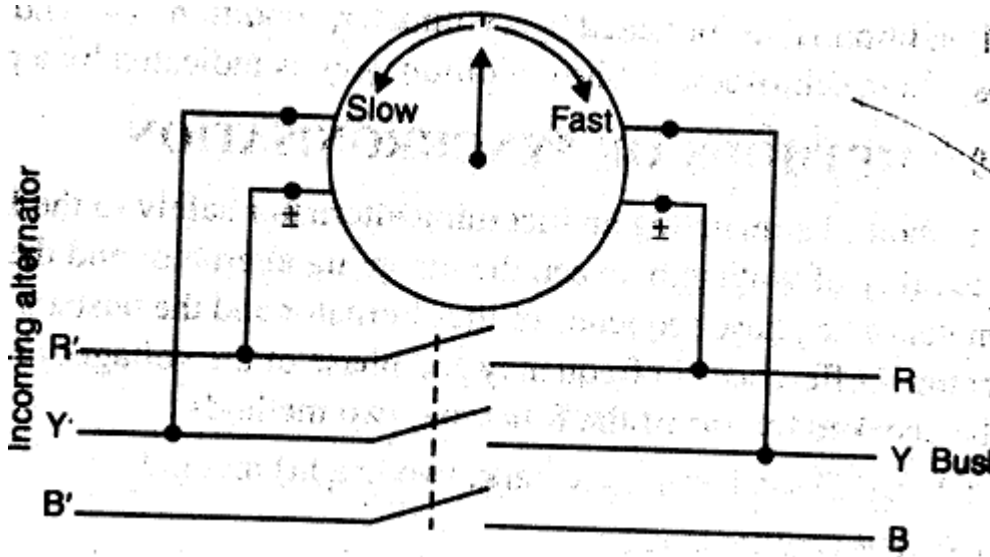

Fig.1.26

### Synchronising action :

When two or more alternators have been connected in parallel, they will remain in stable operation under all normal conditions i.e., voltage, frequency, speed and phase equality will continue. In other words, once synchronised properly, the alternators will continue to run in synchronism under all normal conditions. If one alternator tries to fall out of synchronism, it is immediately counteracted by the production of a synchronising torque which brings it back to synchronism. This automatic action is called the synchronising action of the alternators.

Consider two similar single-phase alternators 1 & 2 operating in parallel as shown in Fig. 1.27 (i). For simplicity, let us assume that the alternators are at no-load. When in exact synchronism, magnitudes of the small e.m.f.s  $E_1$  (Machine 1) &  $E_2$  (machine 2) are equal. These e.m.f.s are acting in the same direction with respect to the external circuit as shown in Fig. 1.27(ii). But in relation to each other, these e.m.f.s are in phase opposition i.e., if we trace the closed circuit formed by the two alternators we find that the e.m.f.s oppose each other as shown in Fig 1.27(iii). When the alternators are in exact synchronism,  $E_1$  &  $E_2$  are in exact phase opposition. Since,  $E_1 = E_2$  in magnitude, no current flows in the closed circuit formed by the two alternators.

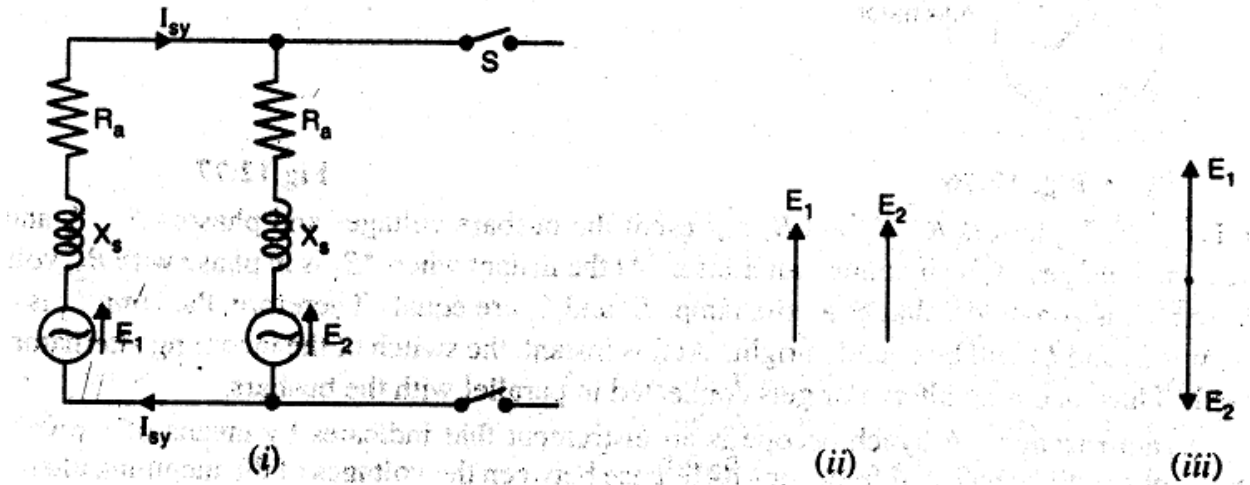

Fig.1.27

If one alternator drops out of synchronism, there is an automatic action to re-establish synchronism.

Let us discuss this point.

- (i) **Effect of speed change** : Suppose, due to any reason ,the speed of machine2 falls .Then emf  $E_2$  will fall back a phase angle of  $\alpha$  electrical degrees as shown in Fig 1.28.(though still  $E_1 = E_2$ ).There will be resultant e.m.f.  $E_r$  in the closed circuit formed by the two alternators.The emf  $E_r$  will circulate current (known as synchronising current  $I_{sy}$ ) in this closed circuit.

Synchronising current  $I_{sy} = \frac{E_r}{Z_s}$

The current  $I_{sy}$  lags behind  $E_r$  by an angle given by :

$$\tan \theta = \frac{X_s}{R_a} = \frac{X_s}{R_a}$$

$R_a$  = armature resistance of each alternator

$X_s$  = synchronous reactance of each alternator

$Z_s$  = synchronous impedance of each alternator

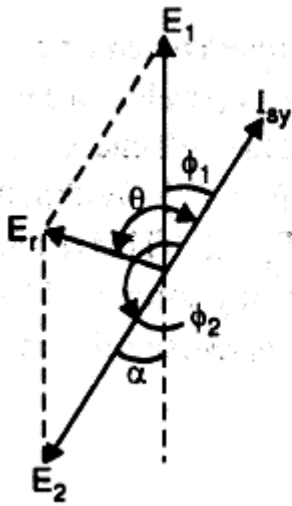

Fig.1.28

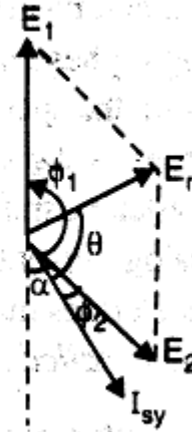

Fig.1.29

Since,  $R_a$  is very small as compared to  $X_s$ ,  $\theta$  is nearly  $90^\circ$  so that the current  $I_{sy}$  is almost in phase with  $E_1$  & in phase opposition to  $E_2$ . This means that machine 1 is generating and machine 2 is motoring. Consequently, the machine 1 tends to slow down and machine 2, by accepting power, tends to accelerate. This restores the status quo i.e., synchronism is re-established.

Conversely, if  $E_2$  tends to advance in phase, as shown in Fig. 1.29 the directions of  $E_r$  and  $I_{sy}$  are changed such that now machine 2 is generating and machine 1 is motoring. Once again the synchronism is restored.

- (ii) **Effect of inequality of e.m.f.s** : The automatic re-establishment of synchronism of two alternators operating in parallel also extends to any changes tending to alter the individual e.m.f.s. When in exact synchronism, then  $E_1 = E_2$  (magnitude) and they are in exact phase opposition as shown in Fig. 1.30(i). Suppose due to any reason, e.m.f.  $E_1$  increases. Then resultant e.m.f.  $E_r$  exists in the closed circuit formed by the two alternators. Then  $E_r = E_1 - E_2$  and is in-phase with  $E_1$ . The resultant e.m.f.  $E_r$  sends synchronising current  $I_{sy}$  in the closed circuit. Here again the current  $I_{sy}$  almost lags behind  $E_r$  by  $90^\circ$  (as  $Z_s = X_s$ ) as shown in Fig. 1.30(ii). Also  $I_{sy}$  lags almost  $90^\circ$  behind  $E_1$  and leads  $E_2$  almost by  $90^\circ$ . The power produced is practically zero; just enough to overcome copper losses. The current  $I_{sy}$  lags behind  $E_1$  and produces a demagnetising armature reaction effect on machine 1. At the same time  $I_{sy}$  leads  $E_2$  and produces magnetising armature reaction effect on the machine 2. Thus,  $E_1$  tends to fall and  $E_2$  tends to rise. The

result is that synchronism is re-established. The converse is true for  $E_2 > E_1$  as shown in Fig.1.30(iii)

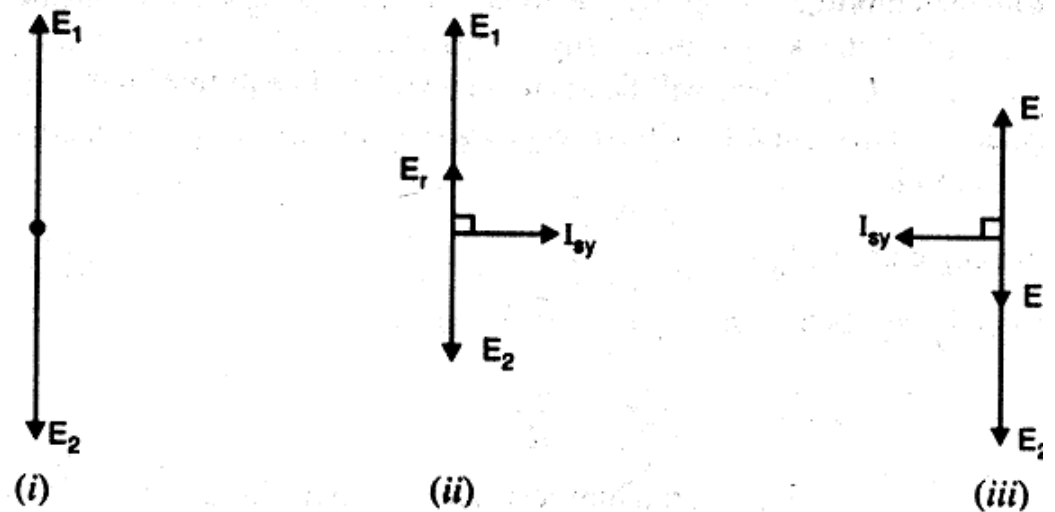

Fig.1.30

### SYNCHRONISING POWER :

When two alternators are operating in parallel, each machine has an inherent tendency to remain synchronised. Consider two similar single-phase alternators 1 & 2 operating in parallel at no-load as shown in Fig. Suppose, due to any reason, the speed of machine 2 decreases. This will cause  $E_2$  to fall back by a phase angle of  $\alpha$  electrical degrees as shown in Fig.1.31 (though still  $E_1 = E_2$ ). Within the local circuit formed by two alternators, the resultant e.m.f.  $E_r$  is the phasor difference  $E_1 - E_2$ . This resultant e.m.f. results in the production of synchronising current  $I_{sy}$  which sets up synchronising torque. The synchronising torque retards machine 1 and accelerates machine 2 so that synchronism is re-established. The power associated with synchronising torque is called synchronising power.

In Fig.1.32, machine 1 is generating and machine 2 is motoring. The power supplied by machine 1 is called **synchronising power**.

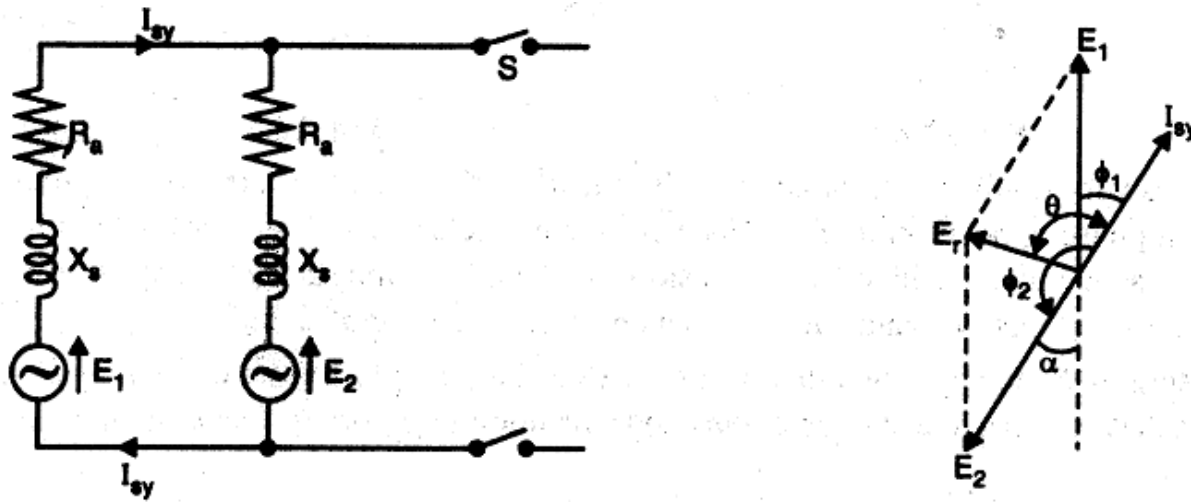

Fig.1.31

Fig.1.32

Referring to Fig.1.32 we have,

Synchronising power ,  $P_{sy} = E_1 I_{sy} \cos \phi_1 = E_1 I_{sy} \cos(90^\circ - \theta) = E_1 I_{sy} \sin \theta$   
 $= E_1 I_{sy}$  ( As  $\theta = 90^\circ$  so that  $\sin \theta = 1$ )

The synchronizing power goes to supply power input to machine 2 and the Cu losses in the local circuit of two machines.

$\therefore E_1 I_{sy} = E_2 I_{sy} + \text{Cu losses}$

Resultant e.m.f. ,  $E_r = 2E \cos(\frac{\alpha}{2})$  [ As  $E_1 = E_2 = E$  (say)]

$= 2 E \cos(90^\circ - \frac{\alpha}{2}) = 2 E \sin(\frac{\alpha}{2}) = 2 E \times \frac{\alpha}{2}$  ( As  $\alpha$  is small)  
 $= \alpha E$

Note that in this expression,  $\alpha$  is in electrical radians.

synchronising current  $I_{sy} = \frac{E_r}{2X_s}$  .....  $R_s$  of both machines is negligible

Here  $X_s$ =synchronizing reactance of each machine

$\therefore$  synchronizing power supplied by machine 1 is  $P_{sy} = E_1 I_{sy} = E \frac{E_r}{2X_s} = \frac{E^2 \alpha}{2X_s}$

$P_{sy} = \frac{\alpha E^2}{2X_s}$

Total synchronizing power for three phases  $= 3 P_{sy} = \frac{3 E^2 \alpha}{2X_s}$

Note that this is the value of synchronizing power when two alternators operate in parallel at no-load.

.....XXXXXXXXXXXXXXXXXXXXXXXXXXXXX.....

## SYNCHRONOUS MOTOR

### Defination :

A synchronous Motor is electrically identical with an alternation.

### **Characteristic Feature** :→

- (1) It runs either at synchronous speed or not at all. The only way to change its speed is to vary the supply frequency  $\left( N_s = \frac{120f}{P} \right)$ .
- (2) It is not inherently self starting. It has be run upto synchronous (or nearly synchronous) speed by means before it can be synchronorised to the supply
- (3) It is capable of being operated under a wide range of power factor both lagging and leadig.

### **Construction** :→

Like an alternator, a synchronous motor has the following main parts :

- (i) A stator which houses 3-phase distributed armature winding in the slots of the stator core and receives powers from a 3 $\phi$  -supply.
- (ii) A rotor that has a set of salient poles excited by direct current to form alternator N and S poles.

The exciting coil are connected in series to the slip rings and direct current is fed in to the winding from an external excite on mounted on the rotor shaft.

The stator is wound for the same number of poles as the rotor poles

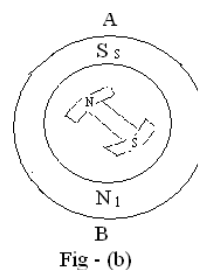
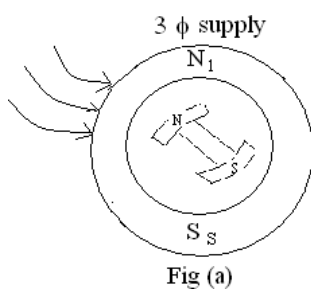

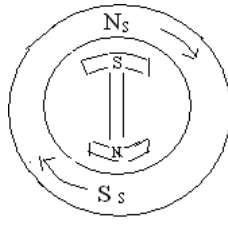

Fig - (c)

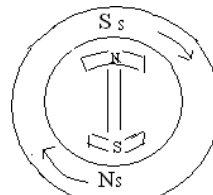

Fig-(d)

### Principle of Operation :→

When a  $3\phi$  winding is fed by a  $3\phi$  supply then a magnetic field of constant magnitude but rotating synchronous speed is produced in the stator. Consider a two pole stator which are shown two stator pole  $N_s$  and  $S_s$  rotating at synchronous speed in clockwise direction.

With the rotor position as shown in fig. suppose the stator pole are at that instant situated at point B. The two similar poles N and  $N_s$  as well as S and  $S_s$  will repel each other with the result that the rotor tends to rotate on the anticlockwise direction.

But half a period later stator poles having rotate around interchange their position i.e.  $N_s$  is at point B and  $S_s$  is at point A. Under these condition  $N_s$  atleast S and  $S_s$  attract N. Hence rotor tends to rotate clockwise (which is just the reverse direction).

It is seen that due to continuous and rapid rotation the stator pole, the rotor is subjected a torque which is rapidly reversing owing to this large inertial, the rotor cannot instantaneously respond to such likely reversing torque with the result that it remains stationary.

Considering the condition in fig(b) the stator and rotor are alternating each other. Suppose that the rotor is not stationary but is rotating clockwise with such a speed that it rotates through one pole pitch by the times the stator poles interchanged their positions. As shown in fig(c). Hence again stator and rotor poles attract each other. It means that if the rotor pole also shift their position along with the stator poles, then they will produce a torque.

### Method of starting :

The following steps are adopted for starting of a synchronous motor.

- (1) The fed winding is shorted that means D.C. excitation is not given to the field winding.
- (2) Reduced voltage with the help of auto-trans transformer is applied across the stator terminal.
- (3) When the motors at far nearly 9% of the synchronous speed, a d.c. excitation as applied to the field winding. At that time the motor is synchronized.



- (4) full supply voltage is applied across stator terminals by cutting out the autotransformer .
- (5) the motor then can be operated at any power factor by the d.c. excitation.
- (6) At light load or heavy load condition the rotor advances and backs to the stator flux respectively with an angle  $\alpha$ . It is called the load angle.

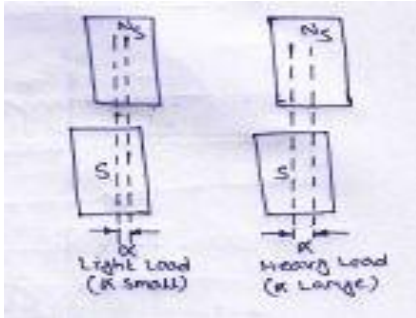

### Motor on no-load :

When a 3 $\phi$  supply is feed to a synchronous motor, the motor starts rotating. As a result back emf ( $E_s$ ) is set up in the alternator (stator) by the rotor flux which oppose the applied voltage 'V' his back emf of ( $E_s$ ) depends on rotor excitation only (and not on speed) as in D.C. motor. The net voltage of armature (stator in the voter difference of V &  $E_b$  Armature current is obtained by dividing this vector difference of voltage by the armature impedance

$$\text{i.e. } I_a = \frac{\vec{V} - \vec{E}_b}{S}$$

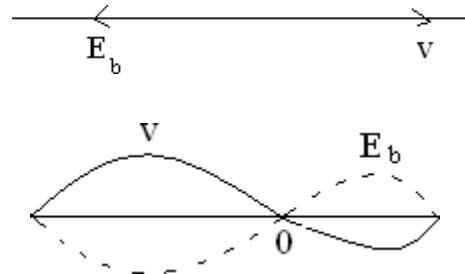

The Fig, show condition when the motor is running on no- direction on no-load & is having loss. As field excitation is given such that  $E_b = V$

The vector difference of  $E_b$  & V is f hence hence the armature current is also zero)

If the motor is on no load but it has losses then  $\theta$  vector for  $E_b$  faces back by a certain angle ' $\alpha$ ' . So that a resultant voltage  $E_R$  & hence current ' $I_a$  is brought into existence which supplies the losses.

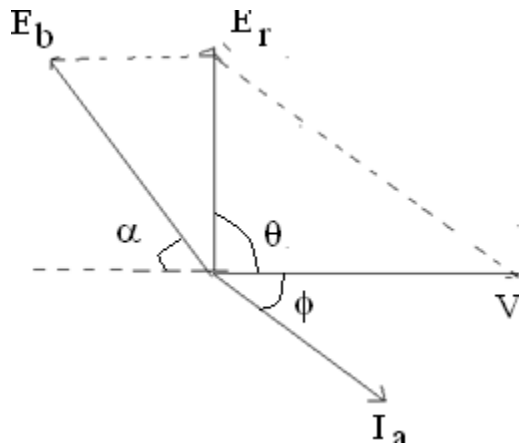

**Motor on Load :**

( Effect of varying load with constant excitation)

If the load motor is landed then the back emf ( $E_b$ ) places back by a certain value called the “load angle” or coupling angle.

The net voltage current the armature  $E_R = V - E_b$

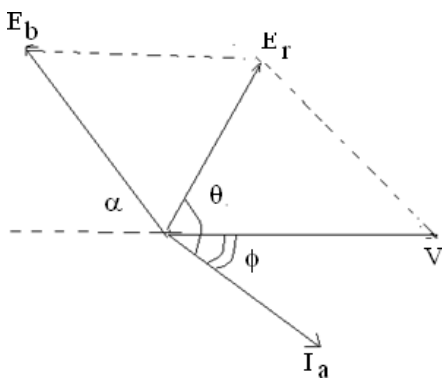

If the motor is further loaded, its rotor further back by a greater value of load angle ‘ $\alpha$ ’ the resultant voltage ‘ $E_R$ ’ is increased and the motor draws an increased armature current but at a devised power factor.

$$I_a = \frac{\vec{V} - \vec{E}_b}{Z_s} = \frac{\vec{V} - \vec{E}_b}{R_a + jX_s}$$

$$\Rightarrow V = E_b + I_a Z_s$$

$$= E_b + I_a (R + jX_s)$$

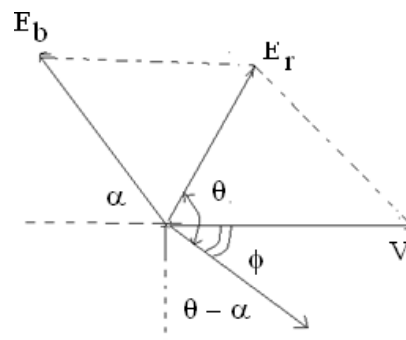

Where  $Z_s =$  Synchronous impedance / phase

$R_a =$  Armature resistance / phase

$X_s =$  Synchronous reactance / phase

The angle ' $\theta$ ' is known as "initial angle" by which ' $I_a$ ' lags behind  $E_R$ .

$$\theta = \tan^{-1} \frac{X_s}{R_a}$$

$\phi$  is the phase angle by which ' $I_a$ ' lags behind ' $V$ '.

If  $R_a$  is negligible, then  $\theta = 90^\circ$

Motor I/p per phase =  $V I_a \cos \phi$

Total I/p to the motor =  $\sqrt{3} V_L I_L \cos \phi$

Mechanical power developed in the rotor per phase

$$P_m = E_b I_a \cos(\alpha - \phi)$$

### Different Power stages in a Synchronous Motor

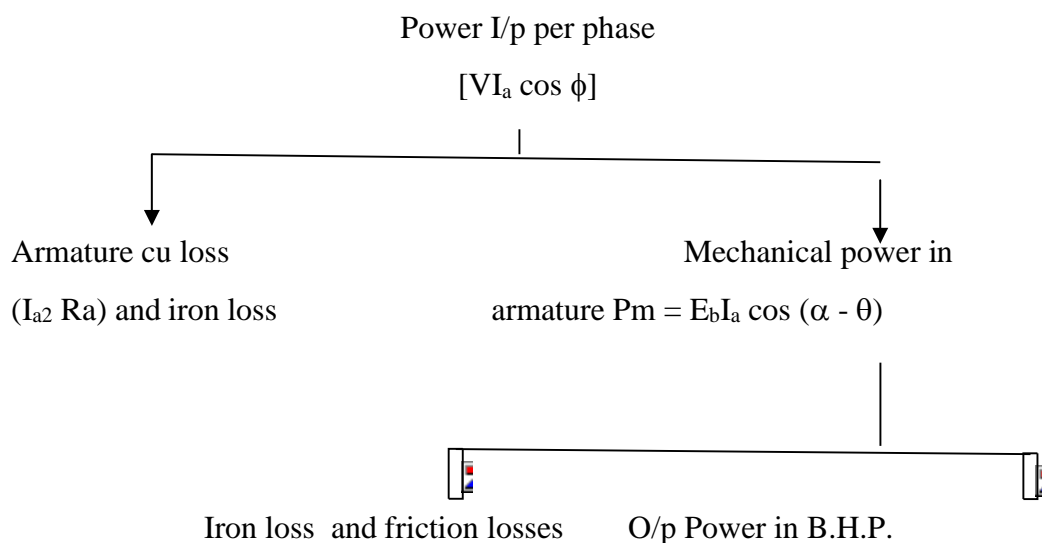

**Power or Torque Developed by the Motor :**



$$\begin{aligned} \frac{dP_m}{d\alpha} &= 0 \\ \Rightarrow \frac{d}{d\alpha} \left[ \frac{E_b V}{Z_s} \cos(\theta - \alpha) - \frac{E_b^2}{Z_s} \cos^2 \theta \right] &= 0 \\ \Rightarrow \frac{E_b V}{Z_s} [-\sin(\theta - \alpha)] - 0 &= 0 \\ \Rightarrow \frac{E_b V}{Z_s} - \sin(\theta - \alpha) &= 0 \\ \Rightarrow \sin(\theta - \alpha) &= 0 \\ \Rightarrow \sin(\theta - \alpha) &= \sin 0 \\ \Rightarrow \theta - \alpha &= 0 \\ \Rightarrow \theta &= \alpha \end{aligned}$$

Value of maximum power

$$\begin{aligned} (P_m)_{\max} &= \frac{E_b V}{Z_s} \cos(\theta - \alpha) - \frac{E_b^2}{Z_s} \cos^2 \theta \\ &= \frac{E_b V}{Z_s} - \frac{E_b^2}{Z_s} \cos^2 \theta \\ &= \frac{E_b V}{Z_s} - \frac{E_b^2}{Z_s} \cos^2 \theta \end{aligned}$$

Now, maximum power developed in the rotor depends on the value of internal angle 'θ'.

→ When  $\theta = \alpha = 90^\circ$

The power will be maximum.

$$(P_m)_{\max} = \frac{VE_b}{Z_s}$$

If 'T<sub>g</sub>' is the gross rotor torque developed by the motor, then

$$\Rightarrow T_g = \frac{P_m}{2\pi N_s} \left. \begin{array}{l} T_g \times 2\pi N_s = P_m \\ N_s \text{ in rps} \end{array} \right\}$$

$$\Rightarrow T_g = \frac{P_m}{2\pi N_s / 60} [N_s \text{ in rpm}]$$

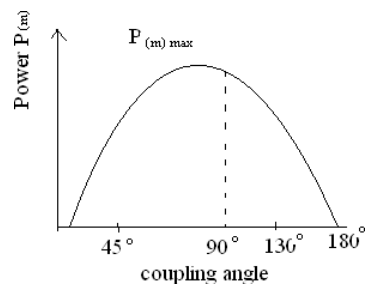

$$\Rightarrow T_g = \frac{60}{2\pi} \times \frac{P_m}{N_s} = \boxed{9.55 \frac{P_m}{N_s} N-m}$$

Shaft torque is given as

$$\boxed{T_{sh} = 9.55 \frac{P_{out}}{N_s}} \quad \text{N-M}$$

### Synchronous Motor with different excitations

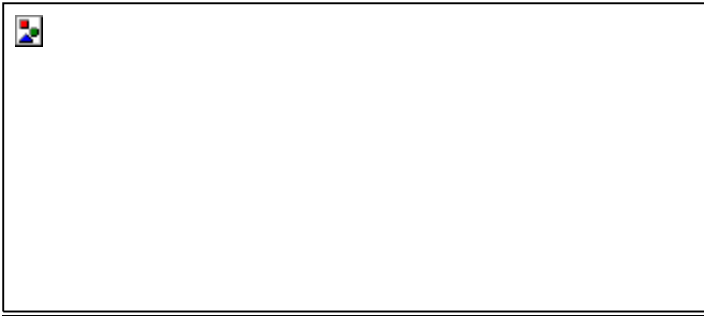

- (i) When  $E_b = V$ , is known as normal excitation
- (ii) When  $E_b < V$ , is known as under excitation, lagging pf.
- (iii) When  $E_b > V$ , is known as over excitation. leading pf.

The diagram shows the induced back emf in various pf.

#### **i) Lagging pf:**

$$AC^2 = AB^2 + BC^2 = [V - E_b \cos(\theta - \phi)]^2 + [E_b \sin(\theta - \phi)]^2$$

$$E_b = \sqrt{[V - I_a Z_s \cos(\theta - \phi)]^2 + [I_a Z_s \sin(\theta - \phi)]^2}$$

#### **ii) Leading pf:**

$$E_b = V + I_a Z_s \cos[180^\circ - (\theta + \phi)] + j I_a Z_s \sin[180^\circ - (\theta + \phi)]$$

#### **iii) Unity pf:**

$$OB = I_a R_a, \quad BC = I_a X_s$$

$$E_b = (V - I_a R_a) + j I_a X_s$$

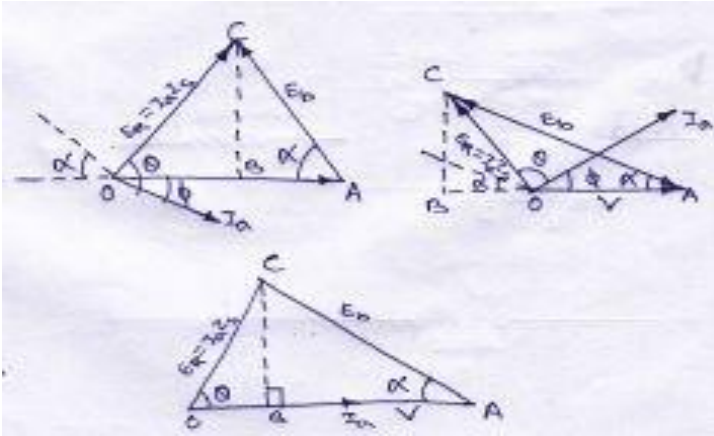

### Motor on Load

⇒ Effect of varying excitation with constant load.

Suppose a synchronous motor is operating with normal excitation ( $E_b = V$ ) at unity power factor with a given load. The armature is drawing a power of  $V I_a$  per phase which is enough to meet the mechanical load on the motor. The effect of changing excitation with load remains constant is discussed below.

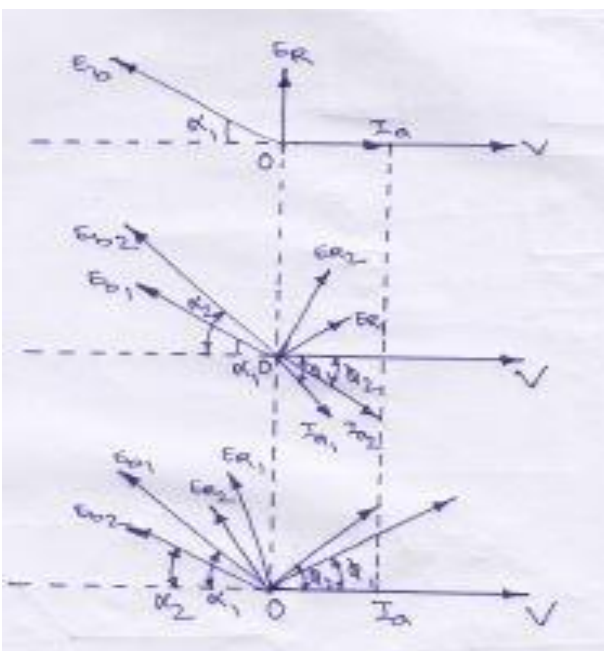
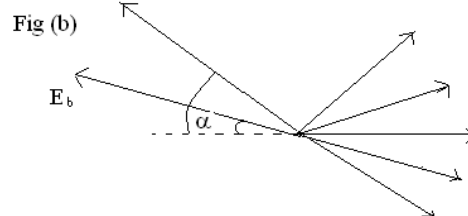
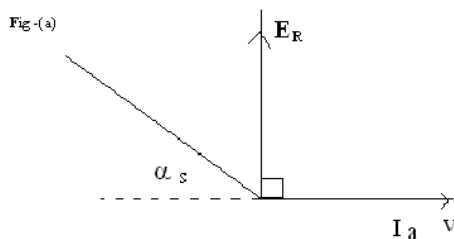

### Excitation Decreases:

As shown in fig (1) suppose due to decrease in excitation, back emf is reduced to  $E_{n_1}$  at the same load angle ' $\alpha$ '. The resultant voltage  $E_{R_1}$  causes a lagging armature current  $I_{a_1}$  to flow. Even though  $I_{a_1}$  is larger than  $I_{a_2}$  in magnitude. It is capable of producing necessary  $VI_a$  for carrying the constant load because  $I_{a_1} \cos \phi_1$  component is less than  $I_a$  so that  $VI_{a_1} \cos \phi_1 < VI_a$ .

Hence, it becomes necessary for load angle to increase from  $\alpha_1$  to  $\alpha_2$ , it increase back emf from  $E_{b_1}$  to  $E_{b_2}$ , which increases resultant voltage from  $E_{R_1}$  to  $E_{R_2}$  consequently, the armature current increases to  $I_{a_2}$  whose in phase component.

### (b) Excitation Increased

The effect of increasing field excitation is shown in fig (c), where increased  $E_n$  is shown at the original load angle  $\alpha_1$ . The resultant voltage causes loading current  $I_{a_1}$  whose in phase component is larger than  $I_a$ . Hence armature develops more power than the load in the motor. Accordingly, load angle decreases from  $\alpha_1$  to  $\alpha_2$  which develops resultant voltage from  $E_{R_1}$  to  $E_{R_2}$  consequently armature current decreases from  $I_{a_1}$  to  $I_{a_2}$  whose in phase component.  $I_{a_2} \cos \phi_2 = I_a$ . In the case armature current develops power sufficient to carry the constant load on the motor.

Hence, it is seen that variations in the excitation of the synchronous motor running with given load. Produces variation in its load angle only.



## Effect of Excitation on Armature Current and Power Factor.

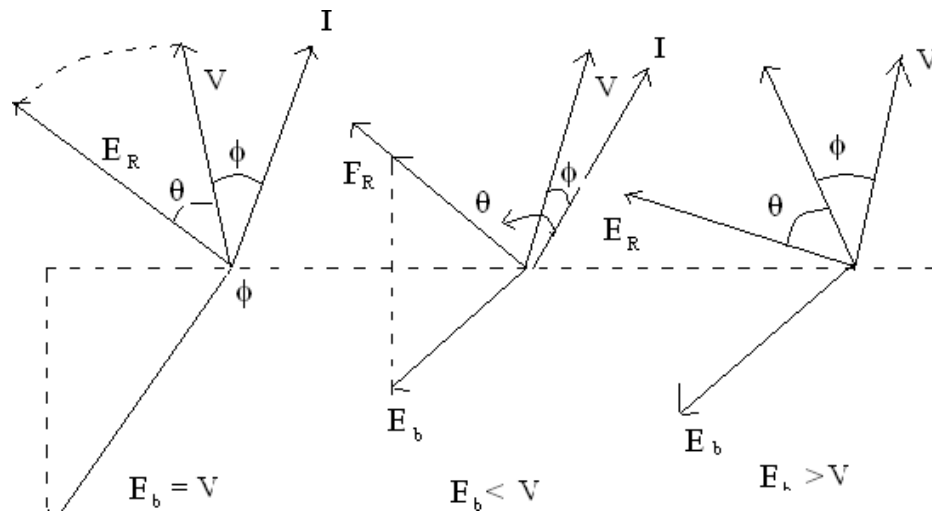

Consider a synchronous motor in which mechanical load is constant.

Fig (a) shows the case for 100% excitation i.e. when  $E_b = V$

The armature current  $I$  lags behind 'V' by an small angle  $\phi$  with  $E_R$  is fixed by stator

constants i.e.  $\tan \theta = \frac{x_s}{R_a}$ . In fig (b), the excitation is less than 100%  $E_b < V$ . Here  $E_R$  is

advanced in clock wise direction & also armature current. The magnitude of 'I' is increased but its power factor is decreased. The component of  $I \cos \phi$  remains the same as before but wattless component  $I \sin \phi$  is increased.

As excitation is decreased  $I$  will increase but p.f. will decrease.

Fig. (c) represents the conduction for over excited motor i.e.  $E_b > V$ . Here the resultant voltage  $E_R$  is pulled in anticlockwise direction & also 'I'. Now the motor is drawing a leading current.

for same voltage of excitation, 'I' will be in phase with 'v' i.e. p.f. is unity AC that the current drawn by the motor would be maximum.

### V-Curve.

Magnitude of armature current varies with excitation. The current has large value for low & high value of excitation. In between them, at any certain excitation. The current is

minimum. The variation of current 'I' with excitation is shown in fig below which is known as V-curve. Since it looks like 'V'.

Motor runs with leading p.f. when over-excited and with lagging p.f. when under excited. In between, the power factor will be unity. The variation of p.f. with excitation (shown in dotted line) which is known as inverted v-curve, since it looks like inverted 'V'. It is seen that the armature current will be minimum when the p.f. will be unity.

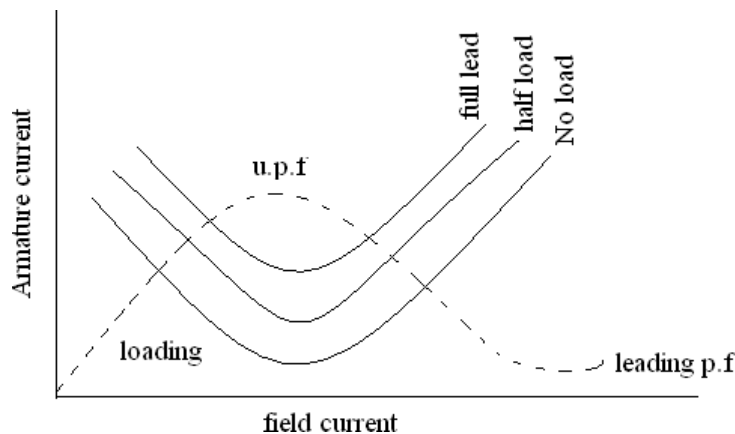

### Synchronous Condenser / Capacitor

Both transformer & induction motor draws lagging currents from the line on light loads, the power drawn by them has a large reactive component and power factor is very low.

It is seen that an over-excited synchronous motor will run with leading p.f. by using synchronous motor and transformers. The power factor can be increased and the reactive components of power can be decreased when synchronous motors are used for this purpose (p.f. improvement), is known as synchronous condenser or synchronous capacitor because it draws a leading current from the line like a capacitors because it draws a leading current from the line like a capacitor.

### **Hunting or Phase Swinging.**

When synchronous motor is used for driving a varying load. Then a condition known as hunting is produced. Hunting may also be caused if supply frequency is pulsating.

When a synchronous motor is loaded its rotor falls back in phase by the coupling angle ' $\alpha$ '. As the load is progressively increased, thus angle also increases so as to produced motor torque to meet with the increased load. If now there is a sudden decrease in the motor load, the rotor is pull back to new value of ' $\alpha$ '. In this way rotor starts oscillating about its new position of equilibrium. Corresponding to the new load. If the time period of those oscillations equals to

the natural time period of the machine, then mechanical resonance is set up. The amplitude of these oscillations may become so large to throw the machine out of synchronous.

To stop the oscillations damper or damping grids are employed. These damper-consists of (short circuited copper were in the faces of the field poles of the motor. The oscillatory motion of the rotor sets up eddy currents in the dampers which flows in such a way as to suppress the oscillations.

### Comparison between induction motor and synchronous motor.

<u>Induction Motor</u>		<u>Synchronous Motor</u>	
1.	Its speed decreases slightly as the load increased.	1.	It runs at either synchronous speed or not at all
2.	It always run with lagging power factor.	2.	It can be run under a wide rang of p.f. both lagging & leading.
3.	It is self –starting.	3.	It is inherently not self-starting.
4.	D.C. excitation is not required	4.	D.C. excitation is required.
5.	It is cheap & simple	5.	It is costlier & complicated.

### Application of Synchronous Motor :

#### 1. Power factor correction :

Over excited synchronous motor having leading p.f. are widely use for improving p.f. of power systems.

#### 2. Constant speed application.

High speed synchronous motor (above 600rpm) are used for centrifugal pumps, belt driven reciprocating, compressor, blowers, line shafts, rubber & paper mills etc.

Low speed synchronous motors (below 600rpm) are used for drives such as centrifugal and screw type pumps, balls and tube mills, vaccum pumps, choppers and metal rolling mills etc.

### 3. Voltage regulation :

The voltage at the end of a long transmission line varies greatly when large inductive loads are present. By installing a synchronous motor with a field regulator, this voltage rise can be controlled.

By varying the excitation, the p.f. can be made lagging or leading which helps to maintain the line voltage at its normal value.

#### Example :- 1

A 75-kW, 3- $\phi$ , Y-connected, 50-Hz, 440-V cylindrical rotor synchronous motor operates at rated condition with 0.8 p.f. leading. The motor efficiency excluding field and stator losses, is 95% and  $X_s = 2.5\Omega$ . Calculate (i) mechanical power developed (ii) armature current (iii) back e.m.f. (iv) power angle and (v) maximum or pull-out torque of the motor.

**Solution :**  $N_s = 120 \times 50/4 = 1500 \text{ rpm} = 25 \text{ rps}$

(i)  $P_m = P_{in} = P_{out} / \eta = 75 \times 10^3 / 0.95 = 78.950 \text{ W}$

(ii) Since power input is known

$$\therefore \sqrt{3} \times 440 \times I_a \times 0.8 = 78.950; \quad I_a = 129 \text{ A}$$

(iii) Applied voltage /phase =  $440/\sqrt{3} = 254 \text{ V}$ . Let  $V = 254 \angle 0^\circ$  as shown in fig

$$\text{Now, } V = E_b + jIX_s \text{ or } E_b = V - jI_aX_s = 254 \angle 0^\circ - 129$$

$$\angle 36.9^\circ \times 2.5 \angle 90^\circ = 250 \angle 0^\circ - 322 \angle 126.9^\circ = 254 - 322$$

$$(\cos 126.9^\circ + j \sin 126.9^\circ) = 254 - 322 (-0.6 + j 0.8) = 516 \angle -30^\circ$$

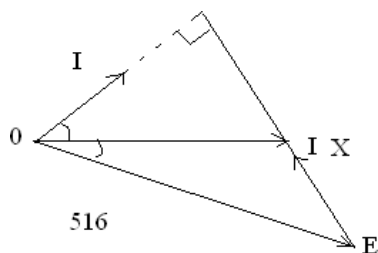

iv)  $\therefore \alpha = -30^\circ$

v) pull-out torque occurs when  $\alpha = 90^\circ$

$$\text{maximum } P_m = 3 \frac{E_b V}{X_s} \sin \delta = 3 \frac{256 \times 516}{2.5} = \sin 90^\circ = 157,275 \text{ W}$$

$$\therefore \text{pull-out torque} = 9.55 \times 157,275 / 1500 = 1,000 \text{ N-m.}$$

### Example : 2

A 20-pole, 693-V, 50Hz, 3 $\phi$ ,  $\Delta$ - connected synchronous motor is operating at no-load with normal excitation. It has armature resistance per phase of zero and synchronous reactance of 10 $\Omega$ . If rotor is retarded by 0.5 $^\circ$ (mechanical) from its synchronous position, compute.

- (i) rotor displacement in electrical degrees
- (ii) armature emf / phase
- (iii) armature current / phase
- (iv) power drawn by the motor
- (v) power developed by armature

How will these quantities change when motor is loaded and the rotor displacement increases to 5 $^\circ$  (mechanical) ?

### Solution :

$$(i) \quad \alpha (\text{elect.}) = \frac{P}{2} \times \alpha (\text{mech})$$

$$\therefore \alpha (\text{elect}) = \frac{20}{2} \times 0.5 = 5^\circ (\text{elect})$$

$$(ii) \quad V_p = V_L / \sqrt{3} = 693 / \sqrt{3}$$

$$= 400 \text{ V,}$$

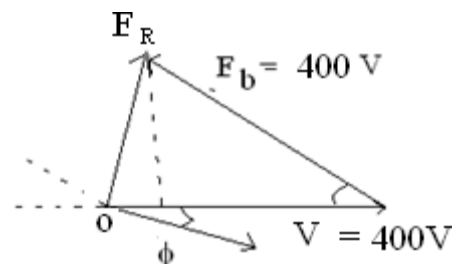

$$\therefore E_R = V_p - E_b \cos \alpha + j E_b \sin \alpha = (400 - 400 \cos 5^\circ + j 400 \sin 5^\circ)$$

$$= 1.5 + j 35 = 35 \angle 87.5^\circ \text{ V / phase}$$

$$(iii) \quad Z_s = 0 + j 10 = 10 \angle 90^\circ; I_a = E_R / Z_s = 35 \angle 87.5^\circ / 10 \angle 90^\circ$$

$$= 3.5 \angle - 2.5^\circ \text{ A / phase}$$

Obviously,  $I_a$  lags behind  $V_p$  by 2.5 $^\circ$

$$(iv) \quad \text{Power input / phase } V_p I_a \cos \phi = 400 \times 3.5 \times \cos 2.5^\circ = 1399 \text{ W}$$

$$\text{Total input power} = 3 \times 1399 = 4197 \text{ W}$$

- (v) Since  $R_a$  is negligible, armature  $Cu$  loss is also negligible. Hence 4197 W also represent power developed by armature.

### Example – 3

The input to an 11000-V, 3-phase, star-connected synchronous motor is 60 A. The effective resistance and synchronous reactance per phase are respectively 1 ohm and 30

ohm. Find (i) the power supplied to the motor (ii) mechanical power developed and (iii) induced emf for a power factor of 0.8 leading.

**Solution :** (i) Motor power input =  $\sqrt{3} \times 11000 \times 60 \times 0.8 = 915 \text{ kW}$

(i) **star Cu loss/phase** =  $60^2 \times 1 = 3600 \text{ W}$ ; Cu loss for three phase =  $3 \times 3600 = 10.8 \text{ kW}$

$$P_m = P_2 - \text{rotor Cu loss} = 915 - 10.8 = 904.2 \text{ kW}$$

$$V_P = 11000\sqrt{3} = 6350 \text{ V}, \phi = \cos^{-1} 0.8 = 36.9^\circ;$$

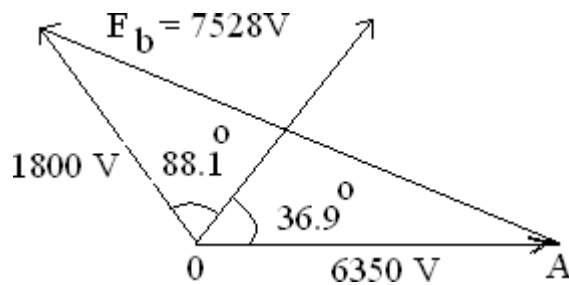

$$\theta = \tan^{-1}(30/1) = 88.1^\circ;$$

$$Z_s = 30 \Omega; \text{ stator impedance drop/ phase} = I_a Z_s$$

$$= 60 \times 30 = 1800 \text{ V}$$

As seen from Fig. 38.25

$$E_b^2 = 6350^2 + 1800^2 - 2 \times 6350 \times 1800 \times \cos(88.1^\circ + 36.9^\circ)$$

$$= 6350^2 + 1800^2 - 2 \times 6350 \times 1800 \times -0.572$$

$$\therefore E_b = 7528 \text{ V}; \text{ line value of } E_b = 7528 \times \sqrt{3} = 1.3042.$$

**Example -4 :** A 500-V, 1-phase synchronous motor gives a net output mechanical power of 7.46 kW and operates at 0.9 p.f. lagging. Its effective resistance is  $0.8 \Omega$ . If the iron and friction losses are 500 W and excitation losses are 800 W, estimate the armature current. Calculate the commercial efficiency.

**Solution :** Motor input =  $V I_a \cos \phi$ ; Armature Cu loss =  $I_a R_a^2$  Power developed in armature is  $P_m = V I_a \cos \phi - I_a R_a^2$

$$\therefore I_a^2 R_a - V I_a \cos \phi + P_m = 0 \quad \text{or } \therefore I_a = \frac{V \cos \phi \pm \sqrt{V^2 \cos^2 \phi - 4 R_a P_m}}{2 R_a}$$

Now,  $P_{\text{out}} = 7.46 \text{ kW} = 7,460 \text{ W}$

$$P_m = P_{out} + \text{iron and friction losses} + \text{excitation losses}$$

$$= 7460 + 500 + 800 = 8760 \text{ W}$$

$$I_a = \frac{500 \times 0.9 \pm \sqrt{(500 \times 0.9)^2 - 4 \times 0.8 \times 3760}}{2 \times 0.8} = \frac{450 \pm 417.7}{1.6} = \frac{32.3}{1.6} = 20.2 \text{ A}$$

### Example :- 5

The synchronous reactance per phase of a 3-phase star-connected 6.600 V synchronous motor is  $10\Omega$ . For a certain load, the input is 900 kW and the induced line emf is 8,900 V. (line value) Evaluate the line current. Neglect resistance.

**Solution :** Applied voltage / phase =  $6.600 / \sqrt{3} = 3,810 \text{ V}$

Back e.m.f. / phase =  $8,900 / \sqrt{3} = 5,140 \text{ V}$

$$\text{Input} = \sqrt{3} V_L \cdot I \cos \phi = 900,000$$

$$\therefore I \cos \phi = 9 \times 10^5 / \sqrt{3} \times 6.600 = 78.74 \text{ A}$$

In  $\Delta ABC$  of vector diagram in Fig we have  $AB^2 = AC^2 + BC^2$

$$\text{Now } OB = I X_s = 10 I$$

$$BC = OB \cos \phi = 10 \times 78.74 = 787.4 \text{ V}$$

$$\therefore 5,140^2 = 787.42 + AC^2$$

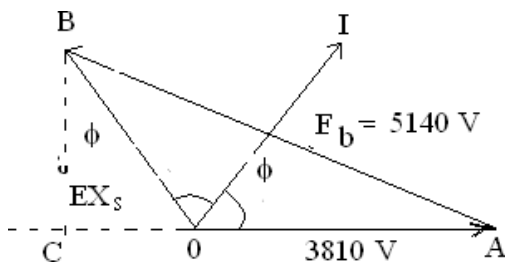

$$\therefore AC = 5,079 \text{ V}$$

$$OC = 5,079 - 3,810 = 1,269 \text{ V}$$

$$\tan \phi = 1269 / 787.4 = 1.612 \quad \phi = 58.2^\circ, \quad \cos \phi = 0.527$$

$$\text{Now } I \cos \phi = 78.74; \quad I = 78.74 / 0.527 = 149.4 \text{ A}$$

## **Single Phase induction Motor**

A single phase Induction Motor (I.M.) is very similar to 3 Phase squirrel cage I.M. It has a squirrel cage rotor and a single phase winding on stator like 3 phase I.M., single phase I.M. is not self starting. The stator winding produces a magnetic field which polarity reversed after each half cycle. So the field don't produce rotating field. If a single phase I.M. having squirrel cage rotor and 1-phase distributed stator winding, it doesn't develop any resulting starting torque as the torque developed in both the cycle neutralize each other. To make the I.M. starting, we have to add an another winding in the stator circuit is known as auxiliary winding (starting)

### **Making Single Phase I.M. Self starting :**

To make a 1-phase I.M. self starting we should some how produce a revolving stator magnetic field, this may be achieved by converting a 1-phase supply in to two phase supply by using an additional winding. Hence the rotor of the single phase motor starts rotating like 3 phase motor. When it achieves sufficient speed, the additional winding may be removed. But the rotor continue running.

### **Different types of single phase I.M.-**

1. Induction Motors like split-phase, capacitor and shaded pole type.
2. Repulsion type motors
3. A.C. series motors (Commutator motors) etc.

### **Split Phase Motor:**

The Stator circuit of a split phase I.M. is added with an auxiliary winding with the main winding and it is located  $90^0$  electrically apart from the main winding. The two windings are so designed that the auxiliary winding has high resistance and small reactance while the main winding has low resistance and large reactance.



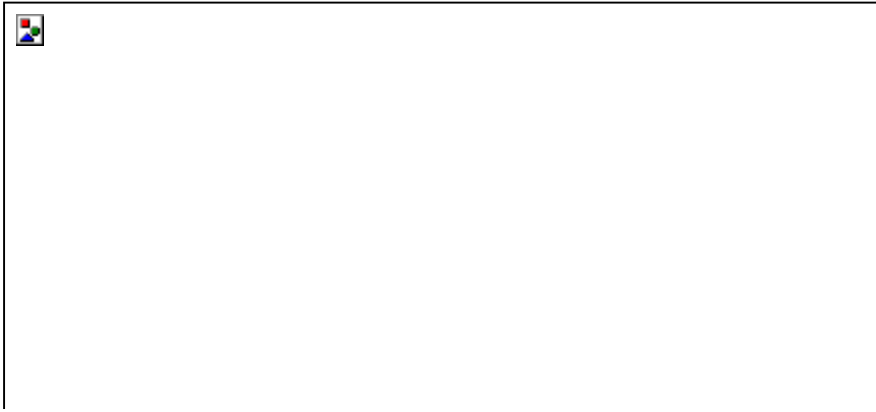

Figure 1 split phase I M

### **Operation-**

When supply is given to the starter windings both the windings are energized. Since main winding is made by highly inductive while the auxiliary winding is resistive that produce a weak revolving field for which it produces revolving flux and rotor starts revolving hence the motor started.

The Torque produced is,

$$T_s = K I_m I_s \sin \alpha$$

When  $\alpha$  is the phase angle between  $I_m$  &  $I_s$ . When the motor achieves about 75 % of synchronous speed, the centrifugal switch S will open and the auxiliary winding is cut off from the circuit. Then the motor operates as a 1 –  $\Phi$  I.M. and it continues to accelerate till it reaches it's normal speed which is below the synchronous speed. The starting torque is proportional to the Current

If the starting period delay exceeds 5 Seconds, the winding may burn out because the winding made of fine wire.

### Uses

Fan, Washing machine, small machine tools etc.

### **Capacitor Start I.M. :**

A Capacitor start motor is identical to a split phase motor except that the starting winding has same number of turns as main winding and a capacitor is connected in series with the starting winding.

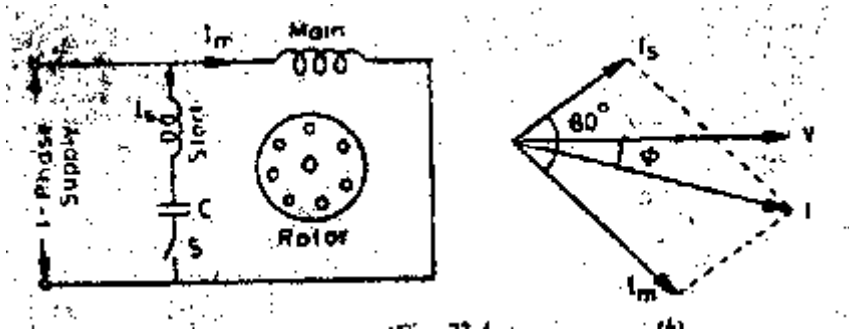

Figure 2 Capacitor Start I.M.

### Operation

The value of the capacitor is such that " $I_s$ " leads " $I_m$ " by The starting torque which is more than the split phase I.M. When torque is produced, the rotor starts rotating. When the rotor achieves 75 % of the  $N_s$ , the centrifugal switch will be open. Then auxiliary winding is cut off from the circuit. The motor then operate as a 1-phase I.M. and continue to accelerate till it reaches it's normal speed.

### *Advantages*

It's starting characteristics are better than the split phase I.M. For the same starting torque, the current of starting winding is only about half that in split phase I.M. so, it is heated less quickly.

Uses :

It is used where low starting torque is required.

### Capacitor start and run

It is similar to capacitor start motor except that the starting winding is not opened after starting. So, when the motor runs both windings are connected in the circuit . It has two capacitors with the starting winding. The capacitor  $C_1$  has smaller capacity than  $C_2$  and is connected in the circuit in series with the starting winding permanently during starting as well as running. The large capacitor  $C_2$  is connected in parallel in  $C_1$  for starting purpose only. When the motor approaches about 75 % of  $N_s$  then Centrifugal switch is opened and the capacitor  $C_2$  is disconnected from circuit.

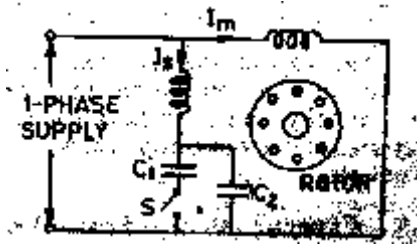

Figure 3 capacitor start induction motor

The important kind of capacitor motor is permanent capacitor motor. In such type the capacitor is permanently connected to the circuit and one in number only.

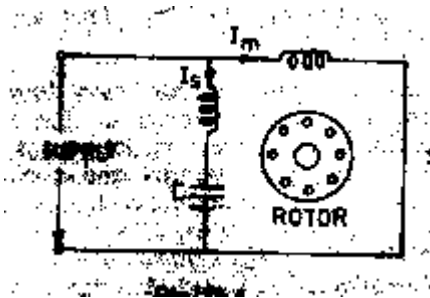

Figure 4 permanent capacitor motor

### **Characteristics**

This type of motor is designed for perfect 2-phase operation at any load and it produces continuous torque as compared to induction motor.

Uses

Due to its continuous torque and vibration free, it is used in hospitals, studio, refrigerators, compressors, stokers, ceiling fan, blowers etc.

### **Shaded Pole Motor**

The shaded pole motor is very popular for rating up to 0.05 HP. A small portion of pole core of about 30% is slot cut and surrounded by a short circuited ring of Cu strip called shading coil.

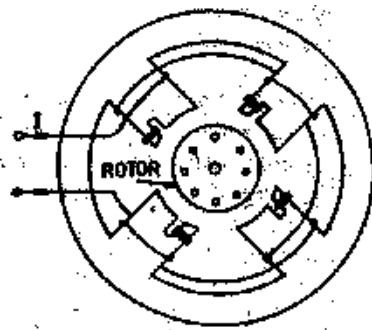

Figure 5 shaded pole motor

## Operation

From the total of core, the flux produced and emf is induced in the shading coil. The resulting current in shading coil is in such a direction, so as to oppose  $I$  and so the change in flux according to Lenz's law. So this flux in the shaded portion of the pole is weakened while in the unshaded portion is strengthened. The magnetic axis lies along the middle of this part.

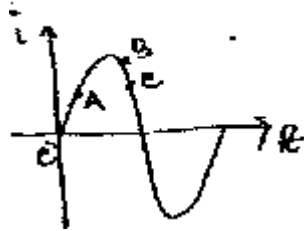

Figure 6 torque in shaded pole motor

During the portion in AB as shown in figure (6), the flux is reached almost maximum value, the flux distribution across the pole is uniform. Since no current is flowing in shading coil, the magnetic axis shift to the centre of the pole.

As the flux decreases as shown in figure (6), from B to C, This again set a induced current in the shading coil. This current flows in such a direction that to oppose the decrease in current. Thus the flux in the shaded portion of the pole is strengthened while the unshaded portion is weakened. So the magnetic axis shift to the middle part of the shaded pole.

This shifting of flux is like a rotating weak field moving in the direction from unshaded portion to shaded portion of the pole. Under the influence of the moving field a small starting torque is developed which torque starts to rotate the rotor, additional torque is produced by single phase motor action. Such motors are built in very small sizes of 5-50w but are simple in construction and are extremely rugged, reliable and cheap. they do not need any commutator, switch, brush, collector rings etc. However they suffer from disadvantages of (i) low starting torque, (ii) very little over load capacity and (iii) very low efficiency ranging from 5% to 35% from lower to higher ratings respectively.

### Uses

It is used in small fans, toys, hair drier of power up to 50 W.

### AC Series Motor / Universal Motor

The construction of AC series motor is as like as DC series motors. If a DC Series motor is connected to an AC supply, it will rotate and produce unidirectional torque because the

current flowing in both the armature and field reverses at the same time. When a DC series motor operates on a single phase supply, then it is called a AC series motor. The performances of this type of motor will not be satisfactory due to the following reasons.

1. The alternating flux would cause excessive eddy current loss in the yoke and the field core will become extremely heated.
2. Sparking will occur at brushes because of huge voltage and current induced in the short circuited armature coil during commutation period.
3. Power factor is very low.

Due to the above drawbacks DC series motor required some changes by which AC supply input disadvantages solved.. The changes made are

- a) The entire magnetic circuit is laminated in order to reduce the eddy current losses.
- b) A high field flux is obtained by using a low reluctance magnetic circuit.
- c) Excessive sparking eliminated by using high resistance leads to connect the coil to the commutator segment.

Though this type of motor can be operated either on AC or DC supply, the resulting torque speed curve is same. It is also known as Universal motor.

### *Operation*

When it is connected to an AC supply the same alternating current flows through the field and armature winding. The field winding produces an alternating flux that react with an armature current to produce a torque and the direction of the torque is always same because they (current and flux) reverses simultaneously.

### Characteristics

- a) Speed increases to a high value with a decreasing load.
- b) It has very high starting torque.
- c) At Full load, the power factor is 90 %.

### Uses.

- a. Sewing machine b. vacuum cleaners, c. mixer grinders and blenders
- d) High speed vacuum cleaners. e. hair driers f. power saw
- f. Drills g. Electric Shaver.

### **Single Phase Repulsion Motor**

A repulsion motor is similar to an Ac Series motor except some modification. The brushes are not connected to supply but are short circuited by themselves. The current induced in the armature conductor by mutual induction method.

### Construction Single Phase Repulsion Motor

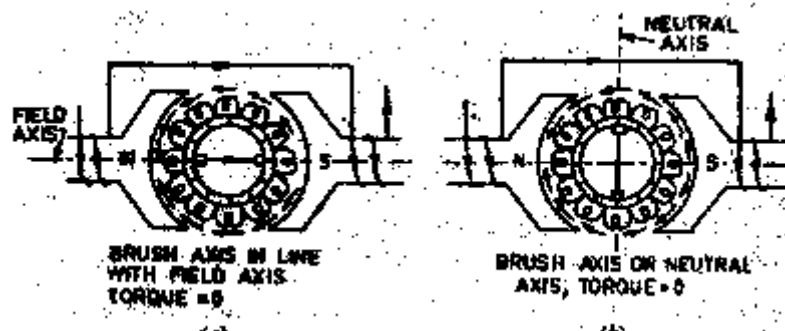

Figure 7 Single Phase Repulsion Motor

The field of the stator winding is connected directly to the AC single phase source. The rotor is similar to a DC motor armature winding connected to the commutator. The brushes are short circuited which make the rotor squirrel cage type. It has very high starting torque and also better power factor as compared to other single phase motor.

#### Operation

The figure shows, two pole repulsion motor with short circuited brushes. The brush axis is parallel to stator field. The emf is induced in the armature conductor by induction method and current flows through the rotor conductors. The current flows from N to S brush in two paths. during this brush position half of the rotor conductors under N pole carry current inward and half carry current outward. The same thing occurs under S pole. Therefore, same torque is produced in opposite direction in both the half coils. So the net torque is zero.

If the brush axis is in some angle other than  $0^\circ$  or  $90^\circ$  then a torque is developed in the rotor and accelerate the rotor to final speed. The brush axis is shifted in clockwise direction through some angle from stator field axis. The emf is induced in same direction, the current flows in two paths of the rotor winding between N & S. Now the more conductors under North pole carrying current in one direction while more conductors under south pole carrying current in opposite direction, so that the torque is developed in clockwise direction and the rotor rotates to its final speed.

The direction of rotation of the rotor depends upon the direction in which the brushes are shifted. If the brushes are shifted in clockwise direction from the stator field axis then the net torque in clockwise direction. It has high starting torque.

#### Use

Commercial refrigerators, compressors and pumps.

## **COMMUTATOR MOTORS**

### A.C. Series Motor or Universal Motor

A dc series motor will rotate in the same direction regardless of the polarity of the supply.

When a dc series motor operates on a single phase ac supply it is called an AC series motor. However some changes are required in a DC motor so that it can satisfactorily operate on A.C. supply.

The changes are as follows:

- i) The field core is constructed of a material having low hysteresis loss. It is laminated in order to reduce eddy current loss. Hence A.C. series motor requires a more expensive construction than a D.C. series motor.
- ii) The series field winding uses as few turns as possible to reduce the reactance of the field winding to minimum. This reduces the voltage drop across the field winding.
- iii) A high field flux is obtained by using low reluctance magnetic circuit.
- iv) There is considerable sparking between the brushes and the commutator when the motor is used on A.C. supply. It is because the alternating flux establishes high currents in the coils short circuited by the brushes. When the short circuited coils break contact from the commutator, excessive sparking is produced. This can be eliminated by using high resistance leads to connect the coils to the commutator segments.
- v) In order to reduce the effect of armature reaction thereby improving commutation and reducing armature reactance a compensating winding is used. This winding is put in the stator slot.

The drawback when A.C. supply is given to D.C. series motor (without modification)

—

- i) The efficiency is low due to hysteresis and eddy current loss.
- ii) The power factor is low due to large reactance of the field and armature winding.
- iii) The sparking at the brush is excessive.

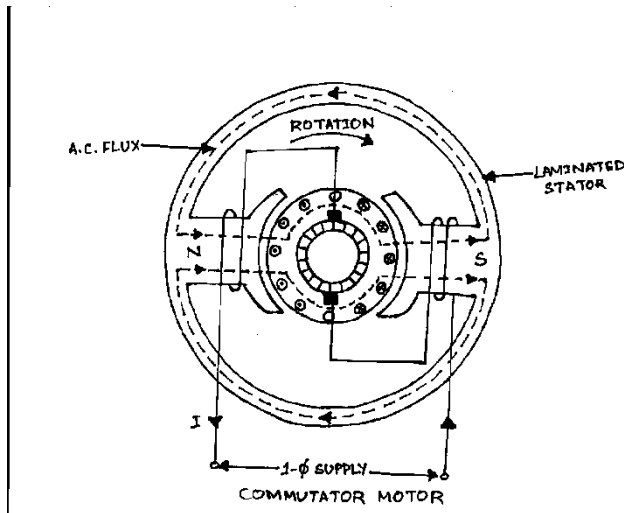

### Construction

The construction of an A.C. series motor is very similar to D.C. series motor except that above modification are incorporated.

This type of motor can be operated either on A.C. or D.C. supply and the resulting torque-speed curve is about the same in each case. For this reason it is sometime called universal motor.

Motors that can be used with a 1-phase A.C. source as well as a D.C. source of supply voltage are called universal motors.

#### Principle of Operation of A.C. series motor

When the motor is connected to an A.C. supply the same alternating current flows through the field and armature windings.

The field winding produces an alternating flux  $\Phi$  that reacts with the current flowing in the armature to produce a torque.

Since both armature current and flux reverse simultaneously, the torque always acts in the same direction.

#### Characteristics of A.C. Series Motor

The operating characteristics are similar to those of D.C. series motor –

- i) The speed increases to a high value with decrease in load.
- ii) The motor torque is high for large armature current, thus giving high starting torque.
- iii) At full load, the power factor is about 90 %, however at starting or when carrying overload power factor is low.



### **Application**

The fractional horsepower A.C. series motor have high speed and large starting torque.

Therefore be used to drive –

- a) High speed vacuum cleaners.
- b) Sewing Machine
- c) Electric Shavers
- d) Drills
- e) Mechanical tools etc.

### **Repulsion Motor**

A repulsion motor is similar to an A.C. series Motor except –

- i) The brushes are not connected to supply but are short circuited. Hence current are induced in the armature conductor by transformer action.
- ii) The field structure has non-silent pole construction

By adjusting the position of short circuited brushes on the commutator, the starting torque can be developed in the motor.

### **Construction**

The field of the stator winding is connected to the 1 –  $\Phi$  A.C. supply.

The armature or rotor with drum type winding like D.C. motor is connected to a commutator.

Here the brushes are not connected to the supply but are connected to each other or short circuited. Hence it is possible to vary the starting torque by changing the brush axis. So

Commutator motor has better power factor than conventional 1-phase motor.

### **Principle of Operation**

Fig. 1 shows two pole repulsion motor with its two short-circuited brushes

When field current is increasing in the direction shown the left hand pole is north pole and right hand pole is south pole.

- i) Here the brush axis is parallel to the stator field.

When the stator winding is energized from 1 –  $\Phi$  supply emf is induced in the armature conductor by induction. This emf will cause a current to flow in the armature conductor. By lens's law the direction of the emf is such that magnetic field of the resulting armature current will oppose the increase in flux.

The current direction in armature conductor is shown in the Fig.

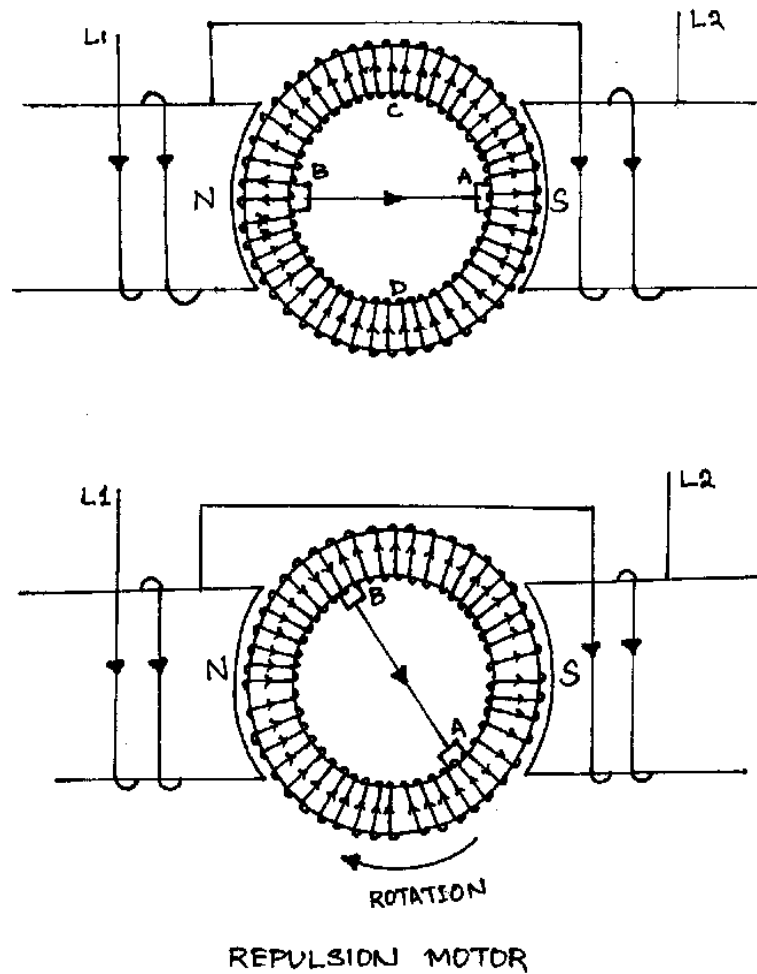

With brushes set in this position, half of the armature conductors under the N-pole carry current inward and half carry current outward. The same is true under south pole.

So as much torque is developed in one direction as in the other and the armature remains stationary.

The armature will also remain stationary if the brush axis is perpendicular to the stator field axis as even then net torque is zero.

If the brush axis is at some angle other than  $0^\circ$  or  $90^\circ$  to the axis of stator field a net torque is developed on the rotor and rotor accelerate to it's final speed.

Here in figure 2 because of the new brush position, the greater part of the conductor under the N-pole carry current in one direction. While the greater part of conductor under S-pole carry current in opposite direction.

With brushes in position 2 torque is developed in the clockwise direction and the rotor quickly attains the final speed.

The direction of rotation of the rotor depends upon the direction in which the brushes are shifted. If the brushes are shifted in clockwise direction from the stator field axis, the net torque acts in the clockwise direction and rotor accelerates in the clockwise direction and vice versa.

The total armature torque in a repulsion motor is

$$T_a = \sin 2\alpha \text{ where } \alpha \text{ is the angle between brush axis and stator field axis.}$$

For maximum torque,  $2\alpha = 90^\circ$  or  $\alpha = 45^\circ$ . Thus adjusting  $\alpha$  to  $45^\circ$  at starting, maximum torque can be obtained during starting period.

Characteristics

- a) The repulsion motor has characteristics very similar to those of an A.C. series motor i.e. it has a high starting torque and a high speed at no load.
- b) The speed which the repulsion motor develops for any given load will depend upon the position of the brushes.
- c) In comparison to other single phase motor, the repulsion motor has high starting torque and relatively low starting current.

### Repulsion Induction Motor

The repulsion – Induction motor produces a high starting torque entirely due to repulsion motor action and when running, it function through a combination of Induction motor and repulsion motor action.

#### **Construction**

The Fig. shows the connection of a 4-pole repulsion Induction motor for 230 V operation. It consist of a stator and a Rotor.

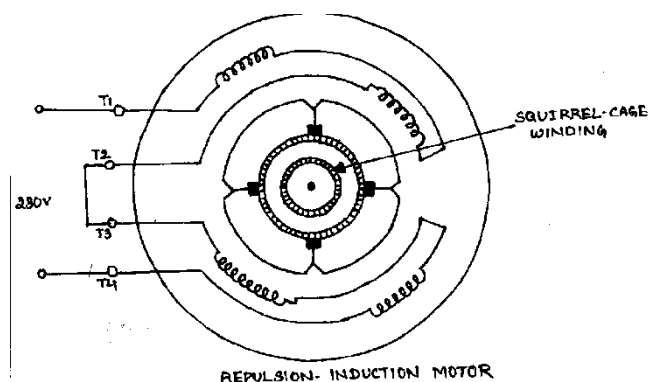

- i) The stator carries a single distributed winding fed from single-phase supply.
- ii) The rotor is provided with two independent windings placed one side the other. The inner winding is a squirrel-cage winding with rotor bars permanently short circuited. The outer winding is a repulsion commutator armature winding placed over the squirrel cage winding.

The repulsion winding is connected to a commutator on which ride short circuited brushes.

### Operation

When single phase stator winding is driven by an A.C. supply the repulsion winding is active. Consequently the motor starts as a repulsion motor with a corresponding high starting torque. As the motor speed increases, the current shifts from the outer to inner winding due to the decreasing impedance of the inner winding with increasing speed. Consequently at running speed, the squirrel cage winding carries the greater part of rotor current. This shifting of repulsion motor action to induction motor action is thus achieved without any switching arrangement.

It may be seen that the motor starts as a repulsion motor. When running, it function through a combination of principle of induction and repulsion.

### Characteristics

The no-load speed of a repulsion – Induction Motor is somewhat above the synchronous speed because of the effect of repulsion winding, however the speed at full load is slightly less than the synchronous speed in an induction motor.

The speed regulation of the motor is about 6 %.

The starting torque is 2.25 to 3 times the full load torque. The starting current is 3 to 4 times the full load current.

### Application

This type of motor is used for applications requiring a high starting torque with essentially constant running speed.

### Repulsion – Start Induction – Run motor

The action of repulsion motor is combined with that of a 1 –  $\Phi$  induction motor to produce repulsion – start induction – run motor (also called Repulsion Start Motor)

This motor starts as an ordinary repulsion motor, but after it reaches about 75 % of its full speed, Centrifugal short – circuiting device / switch short circuits its commutator.

From then on it runs as an Induction Motor with a short – circuited squirrel – Cage Rotor.

After the commutator is short circuited, brushes do not carry any current, hence they may also be lifted from the commutator in order to avoid unnecessary wear and tear and friction losses.

### Characteristics

The starting torque is 2.5 to 4.5 times the full load torque and the starting current is 3.75 times the full load value.

Due to their high starting torque, repulsion motors were used to operate devices such as refrigerators, pumps, compressor etc.

## SPECIAL PURPOSE ELECTRIC MACHINES

### **INTRODUCTION**

Special purpose electric machines have some features that distinguishes them from conventional machines. Stepper motor belongs to that type machine which rotates by a specific number of degrees in response to an input electrical signal and is widely used in digital control systems.

### **STEPPER MOTOR**

Stepper motors are also known as stepping motors or step motors. A stepper motor is an electro-magnetic motor that rotates by a specific number of degrees in response to an input electrical signal. Typical step sizes are  $2^\circ$ ,  $2.5^\circ$ ,  $7.5^\circ$ ,  $15^\circ$  for each electrical pulse. Note that there is no continuous energy conversion so that the rotor does not rotate continuously as in a conventional electric motor. The stepper motor converts electrical pulses into proportionate mechanical movement. Each revolution of stepper motor is made up of a series of definite individual steps. a step is defined as the angular rotation in degrees of the motor each time it receives the electrical pulse. such a step control is required in many applications. Figure 1.1 illustrates a simple application for a stepper motor. Each time the controller receives an input electrical signal, the paper is driven to a certain incremental distance. Stepper motors are relatively cheap and simple in construction and can be made to rotate in steps in either direction. These motors are excellent candidates for such applications as type-writers, control of floppy disc drives, numerical control of machine tools etc. The two most popular types of stepper motors are :

- (i) Permanent-magnet (PM) Stepper Motor
- (ii) Variable –reluctance(VR) Stepper Motor

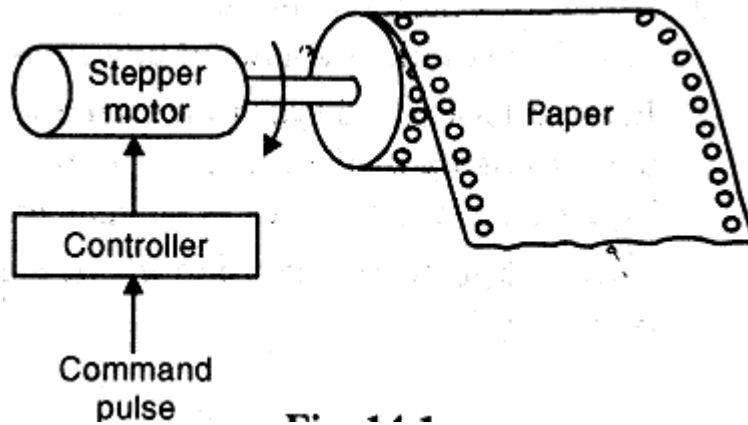

Fig. 1.1

The stator of a stepper motor of either type above carries stator windings which are energized from a dc source to create two or more stator poles. The stator poles are also called stator teeth. The rotor of a stepper motor may be a permanent magnet as in a Permanent Magnet stepper motor or a soft-iron material as in case of a variable reluctance motor. The rotor may also have two or more poles. The rotor poles are also called rotor teeth.

The stator coils are energized in groups referred to as phases. The stator windings may be 2-phase, 3-phase or 4-phase windings. The phase windings are brought out to terminals for DC excitation .

### PM Stepper Motor

The figure 1.2 shows a two-pole 1-phase permanent magnet stepper motor. When the stator is energized, the excitation torque acts on the rotor. The rotor will move to a position where the excitation torque is zero i.e. the rotor will be aligned in parallel to the stator field.

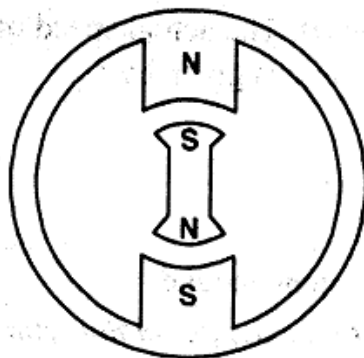

Fig.1.2

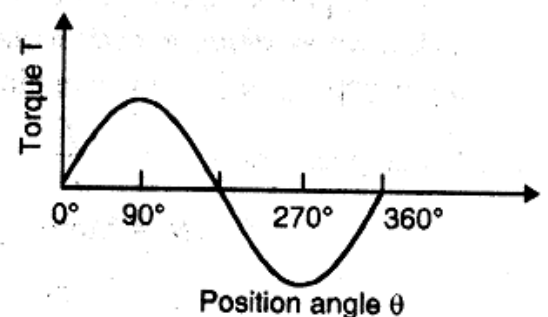

Fig.1.3

Fig 1.3 shows how excitation torque varies with the rotor position for a PM rotor. Note that maximum torque is developed when the rotor is displaced from the stator field by either  $90^\circ$  or  $270^\circ$ . However, the torque is zero and the rotor is aligned (parallel) with the stator field.

(iii) VR Stepper Motor

Fig. 1.4 shows a 2-pole, single phase variable-reluctance (VR) stepper motor. When the stator is energized, reluctance torque acts on the rotor (soft-iron material). The rotor will move to a position where reluctance is minimum and air-gap flux is maximum. This means that rotor teeth will align with the energized stator poles.

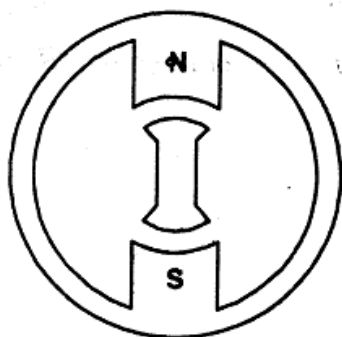

Fig.1.4

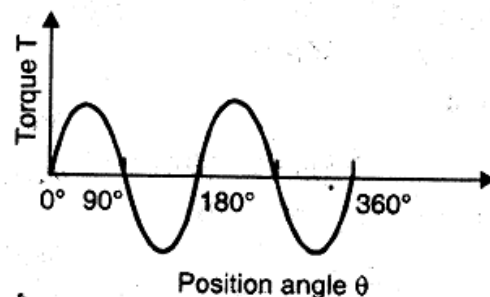

Fig.1.5

Fig.1.5 shows how reluctance torque varies with the rotor position for a VR soft-iron rotor. With the rotor at  $0^\circ$  or  $90^\circ$ , no torque is developed. Maximum torque is developed at  $45^\circ$  and  $135^\circ$  which is the position where reluctance torque forces the rotor or move to position of minimum reluctance.

**step angle** :the angle through which the motor shaft rotates for each command pulse is called step angle. It can be shown that for any PM or VR stepper motor, the step angle can be found from the following two relation:

- i) In terms of stator poles ( $N_s$ ) and rotor poles ( $N_r$ ), the step angle ( $\alpha$ ) is given by:

$$\text{Step angle, } \alpha = \frac{360^\circ}{N_s - N_r} \times 360^\circ$$

where  $\alpha$  = Step angle in degrees

$(N_s)$ =Number of stator poles(or teeth)

$(N_r)$ =Number of rotor poles (or teeth)

ii) In terms of stator phases (m) and rotor poles ( $N_r$ ), the step angle is given by:

$$\text{step angle, } \alpha = \frac{360^\circ}{m N_r}$$

$\alpha$ = step angle in degrees

m=Number of stator phases

$N_r$ =Number of rotor poles (or teeth)

**stepping rate.** An important specification of a stepper motor is the stepping rate. The number of steps per second is known as stepping frequency(f).The actual speed of a stepper motor depends on the step angle ( $\alpha$ ) and stepping frequency(f) and is given by :

$$\text{Speed of stepper motor, } N = \frac{60}{\alpha} f$$

N = motor speed in r.p.m.

f = stepping frequency i.e. steps/second

### Example 1.1

Determine the step angle of a variable-reluctance stepper motor with 12 teeth in the stator and 8 rotor teeth.

Solution :

Number of stator teeth,  $N_s = 12$

Number of rotor teeth,  $N_r = 8$

$$\text{Step angle, } \alpha = \frac{360^\circ}{N_s} \times \frac{360^\circ}{N_r} = \frac{360^\circ}{12} \times \frac{360^\circ}{8} = 15^\circ/\text{step}$$



**Example 1.2**

A stepper motor has a step angle of  $10^\circ$  and is required to rotate at 200 r.p.m. Determine the pulse rate(steps/second) for this motor.

Solution :

motor speed,  $N = \frac{1}{6}$

Hence , Pulse rate(steps per second) for this motor =  $\frac{1}{10} = 120$  steps/second

**PERMANENT –MAGNET (PM) STEPPER MOTOR**

A permanent-magnet(PM) stepper motor is a popular type of stepper motor.It operates on the principle of interaction between permanent-magnet and electromagnetic field.

**CONSTRUCTION** : The stator construction of a PM stepper motor is composed of steel laminations and carries stator windings. The stator phase windings are energized from a d.c. source to create two or more stator poles. The rotor of the motor is a permanent-magnet made up of high retentivity steel alloy.The rotor has even number of poles. Fig.1.6 shows a two-phase,2-pole PM stepper motor. The motor has two rotor poles.The stator coils are grouped to form 2-phase winding i.e.phase-A winding and phase-B winding.The phase winding terminals are brought out for d.c. excitation.

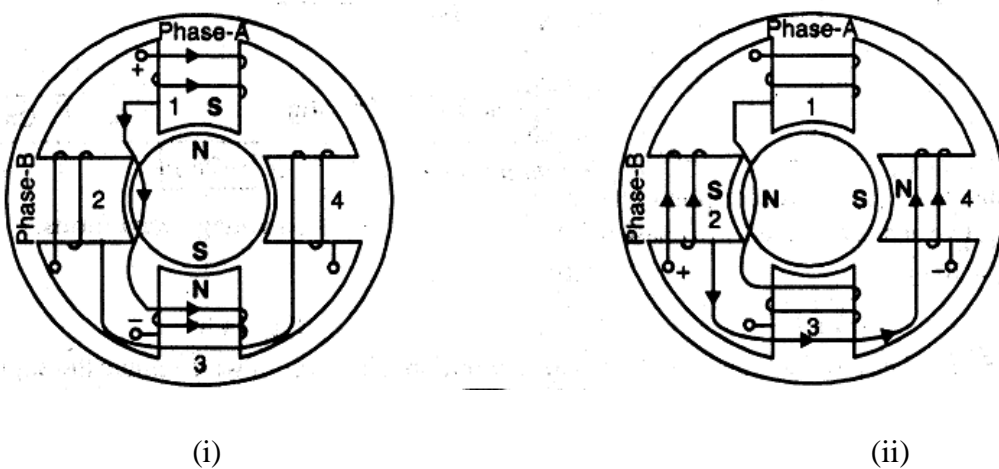

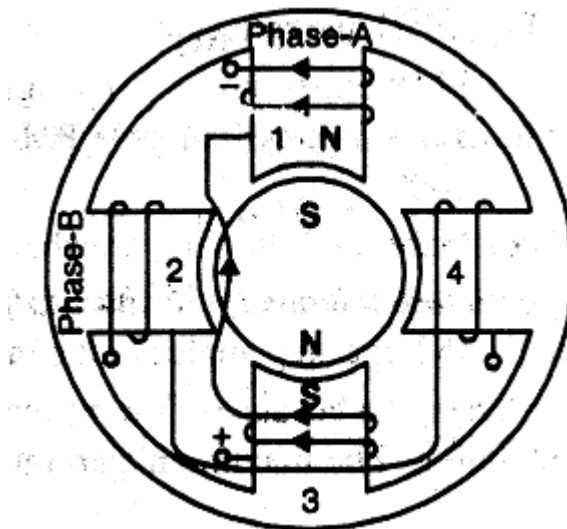

(iii)

Fig.1.6

**OPERATION** : for this PM stepper motor, the number of rotor poles,  $N_r = 2$  and number of phases,  $m=2$ .

$$\text{Step angle, } \alpha = \frac{360^\circ}{m N_r} = \frac{360^\circ}{2 \times 2} = 90^\circ/\text{step}$$

- (i) When only phase-A winding is energized by a constant current as shown in Fig.1.6(i) stator tooth 1 becomes the south pole. This makes the north pole of the PM rotor to align parallel with the south pole (stator tooth 1) of the stator. The rotor will remain locked in this position as long as phase-A winding remains energized. The first row of truth table in Fig. shows that only phase-A winding is excited while phase-B winding is unexcited. Under this condition, step angle  $\alpha = 90^\circ$ . The applied voltage waveforms in Fig also tally with the facts shown in the truth table.
- (ii) If phase A winding is de-energized and phase-B winding is energized as shown in Fig.1.6(ii), stator tooth 2 becomes south pole. As a result, the north pole of the PM rotor aligns parallel with the south pole (stator tooth 2) of the stator. Thus the rotor has displaced  $90^\circ$  in the anticlockwise direction.
- (iii) If phase B winding is de-energized and phase-A winding is excited by a reverse current the rotor will further rotate  $90^\circ$  in anticlockwise direction as shown in Fig.1.6(iii). Now the north pole of PM motor aligns with the stator tooth 3.

**Truth Table**

Cycle	Phase		Position $\delta^\circ$
	A	B	
+	1	0	0
	0	1	90
-	-1	0	180
	0	-1	270
+	1	0	360

Fig.1.7

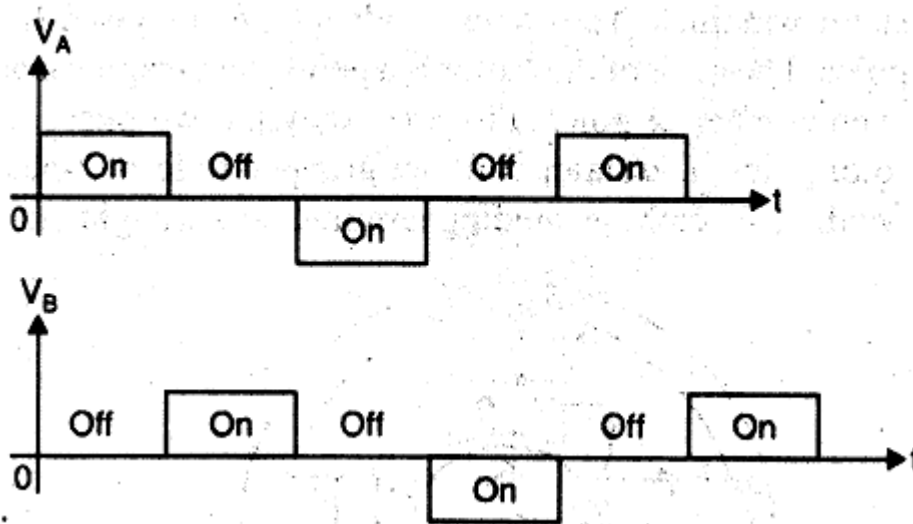

Fig.1.8

- (iv) So far the rotor has completed one-half revolution. However, if we continue the appropriate switching the rotor will complete one revolution in  $90^\circ$  steps.

We can change the step angle of a PM stepper motor by changing the number of rotor poles  $N_r$  and the number of phases ( $m$ ). Thus for a 3-phase, 24-pole PM stepper motor, the step angle  $\alpha = 360^\circ / mN_r = 360^\circ / 3 \times 24 = 5^\circ / \text{step}$ .

**Limitations** : The PM stepper motor has the following drawbacks :

- i) It is difficult to make a small permanent magnet rotor with a large number of poles. Therefore, PM stepper motors are restricted to large step angles in the range of  $30^\circ$  to  $90^\circ$

- ii) The PM stepper motors have high inertia because of the permanent-magnet rotor. Therefore, these motors have slow acceleration. the maximum step rate (Stepping frequency) is 300 steps/second.
- iii) The PM stepper motors have high rotational speed because of large stepping angle. Therefore, motor torque for a given output power is low.

### VARIABLE RELUCTANCE(VR) STEPPER MOTOR

The variable Reluctance stepper motor(VR) stepper motor operates on the same principle as the reluctance motor. that is, when a piece of ferro-magnetic material is free to rotate and is placed in a magnetic field the torque acts on the material to bring it to the position of minimum reluctance to the path of magnetic flux.

**CONSTRUCTION** : The stator construction of a VR stepper motor is the same as that of a PM stepper motor. The stator phase windings are wound on each stator tooth. The rotor is made of soft steel with teeth and slots .Figure shows the basic Variable-Reluctance stepper motor. In this circuit, the rotor is shown with fewer teeth than stator. This ensures that only one set of stator and rotor teeth will align at any given instant. In Fig. the stator has six teeth and the rotor has four teeth. The stator has three phases – A,B and C with teeth 1 and 4, 3 and 6 and 2 and 5 respectfully .For this VR stepper motor,

$$\text{step angle, } \alpha = \frac{360^\circ}{\frac{6}{4}} = 30^\circ/\text{step}$$

Therefore, the rotor will turn ~~each~~ <sup>30°</sup> time a pulse is applied.

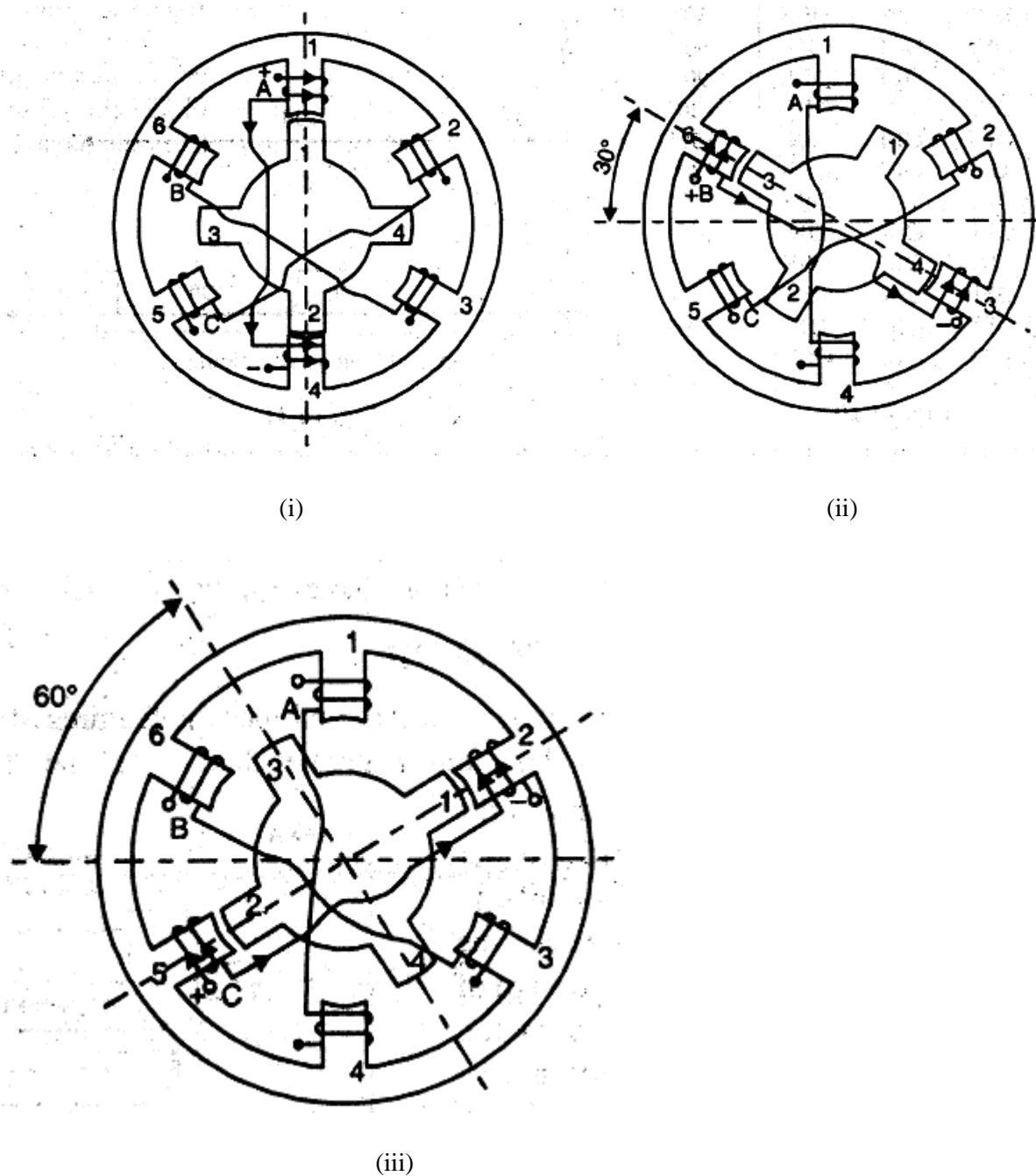

Fig.1.9

**OPERATION** : When the phase winding is energized, the rotor teeth will align with the energized stator poles.

- i) Fig.1.9(i) shows the position of the rotor when phase A is energized with a constant current. As long as phase A is energized, the rotor will be held stationary. Note that in this condition, the rotor teeth 1 and 2 are aligned with the energized stator teeth 1 and 4. The step angle  $\alpha = 0^\circ$ . Also refer to truth table and applied voltage waveform.

- ii) when phase A is switched off and phase B is energized, the rotor will turn  $30^\circ$  clockwise so that the rotor teeth 3 and 4 align with the energized stator teeth 6 and 3.
- iii) The effect of de-energising phase B and energizing phase C is shown in Fig.1.9(iii). In this circuit, the rotor has further moved  $30^\circ$  clockwise so that rotor teeth 1 and 2 align with energized stator teeth 2 and 5.
- iv) after the rotor has displaced  $60^\circ$  clockwise from its starting point, the step sequence has completed one cycle. The truth table in fig. shows the switching sequence to complete a full  $360^\circ$  rotation for the motor with six stator poles and four rotor poles.

**Truth Table**

Cycle	Phase			Position
	A	B	C	
1	ON	OFF	OFF	$0^\circ$
	OFF	ON	OFF	$30^\circ$
	OFF	OFF	ON	$60^\circ$
2	ON	OFF	OFF	$90^\circ$
	OFF	ON	OFF	$120^\circ$
	OFF	OFF	ON	$150^\circ$
3	ON	OFF	OFF	$180^\circ$
	OFF	ON	OFF	$210^\circ$
	OFF	OFF	ON	$240^\circ$
4	ON	OFF	OFF	$270^\circ$
	OFF	ON	OFF	$300^\circ$
	OFF	OFF	ON	$330^\circ$
5	ON	OFF	OFF	$360^\circ$

Fig.1.10

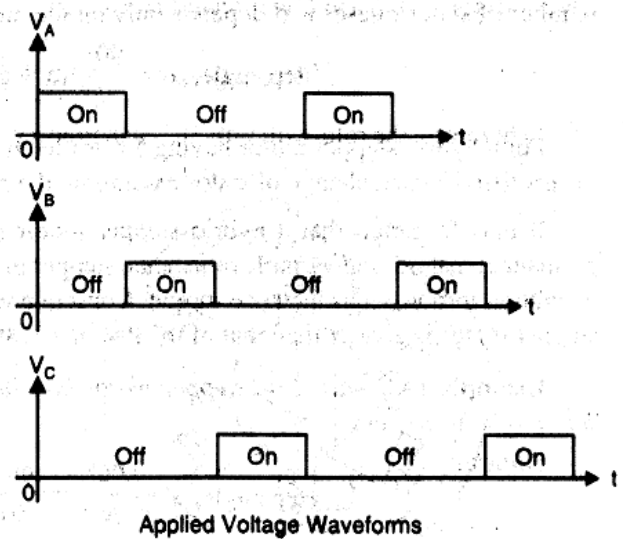

Fig.1.11

The direction of rotation will be reversed if the switching sequence is in the order of A,C and B. For this particular motor, applied voltage must have at least five cycle for one revolution.

## HYBRID STEPPER MOTOR

The hybrid stepper motor combines the features of the PM and the VR stepper motors. The torque developed by this motor is greater than that of the PM or VR stepper motor.

Construction : Fig.1.12 shows the basic construction of a hybrid stepper motor. The stator construction is similar to that of a VR or PM stepper motor. However, the rotor construction combines the design of the rotors of a VR and a PM stepper motor. The rotor of a hybrid stepper motor consists of two identical stacks of soft iron as well as an axially magnetized round permanent magnet. Soft iron stacks are attached to the north and south poles of the permanent magnet as shown in Fig.1.12

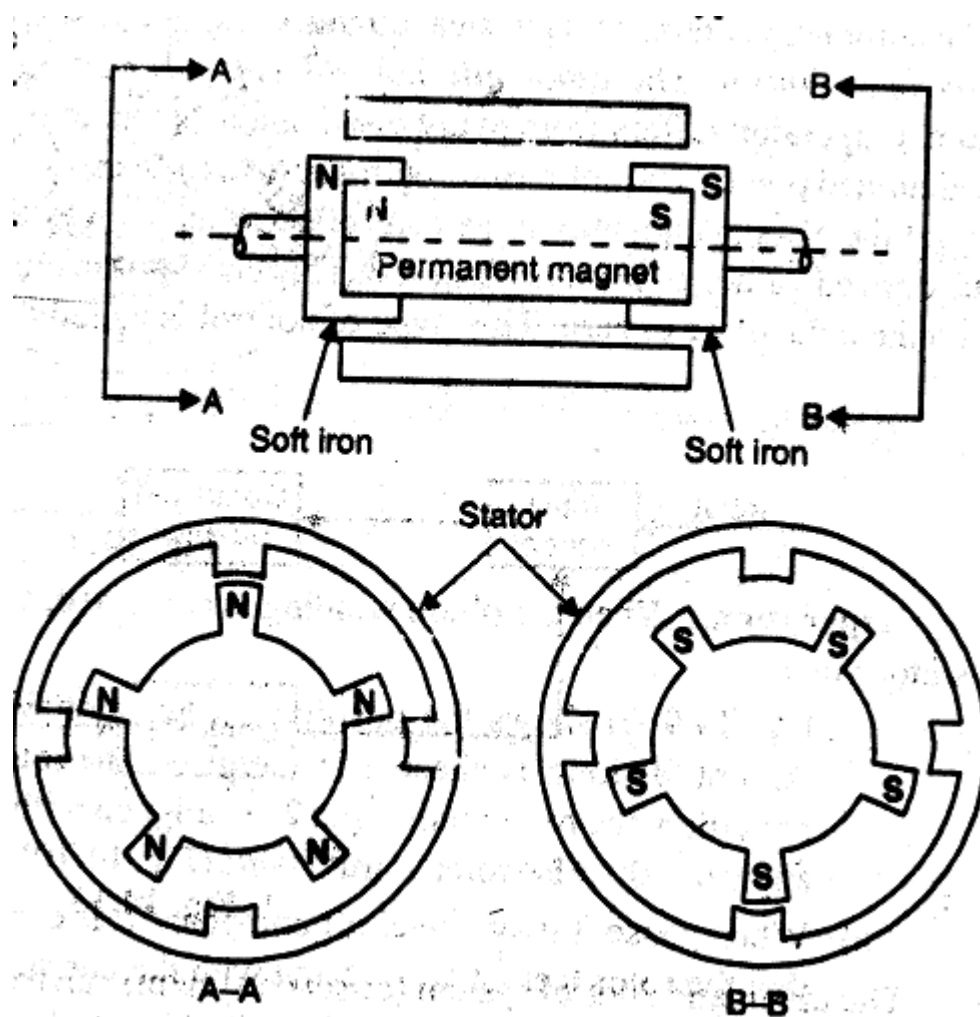

Fig 1.12

The rotor teeth are machined on the soft iron stacks. Thus the rotor teeth on one end become the north pole and those at the other end become the south pole.

This rotor teeth of both north and south poles are displaced in angle for the proper alignment of the rotor pole with that of the stator as shown in Fig.1.12

**OPERATION** : The operating mode of the hybrid stepper motor is very similar to that of a PM or VR stepper motor. The phase windings are energized in proper sequence and the

rotor rotates in steps. Unlike the VR or PM stepper motors, the step angle of a hybrid stepper motor is independent of the number of stator phases and depends only on the number of rotor teeth ( $N_r$ ). It is given by :

Step angle,  $\alpha = 90^\circ/N_r$  in deg

For a hybrid stepper motor having 5 rotor teeth, the step angle  $\alpha = 90^\circ/N_r = 90^\circ/5 = 18^\circ/\text{step}$ . It means that for each change of stator excitation, the rotor will turn by a step of  $18^\circ$ .

It may be noted that a hybrid stepper motor operates under the combined principles of the PM and VR stepper motors. Therefore, the hybrid motor develops both excitation torque and reluctance torque. Consequently the resultant torque developed by the hybrid stepper motor is greater than that of the PM or VR stepper motor.

.....XXXXXXXXXXXXXXXXX.....



## THREE PHASE TRANSFORMER

All alternating current electrical energy is nearly generated by three phase alternating current generators. Similarly three phase systems are used for transmission and distribution of electrical energy. There are several reasons why a three phase system is preferred over a single phase system. Some of the important reasons are

- Smaller size - KVA ratings of three phase generators and horse power ratings of three phase motors for a given physical size are higher than those of similar single phase units.
- Superior operating characteristics - operating characteristics of three phase motors and other appliances are superior to those of similar single phase units.
- Better efficiency - the efficiency of transmission and distribution of power in three phase system are better than in a single phase system.

Alternating current generated through a three phase generator has to be transmitted at higher voltage level for economic reason. Again at the receiving end of transmission line it is necessary to transform the energy through a suitable lower voltage level for distribution. It is therefore often necessary to transform the three phase voltage system to a higher or lower value.

Electric energy may be transferred from one three phase current to another three phase current with a change in voltage by means of a three phase transformer. Voltage transmission on a three phase system may also be performed by using three separate single phase transformer with the winding of the transformer connected in star or delta.

### **Advantages of single three phase transformer over a bank of three single phase transformers**

Recently, three phase transformer are increasingly being used for both step up and step down applications for the following reasons-

- The cost of one three phase transformer is less than the cost of three single phase transformer required to supply the same KVA output.
- The 3 phase transformer weighs less and occupies less space than 3 single phase transformer.
- The bus bar structure, switchgear and other wiring for a three phase transformer installation are simpler than those for three single phase transformer.

But there is one major advantage in using a bank of three single phase transformers than a single three phase transformer. If one single phase transformer among the bank becomes defective, it can be disconnected and power can be supplied by the other two single phase transformers unless replacement/repair is possible. However in a three phase transformer, if one of the phase winding becomes defective, the entire transformer must be taken out of a service for repair work, thereby completely disturbing the power supply.

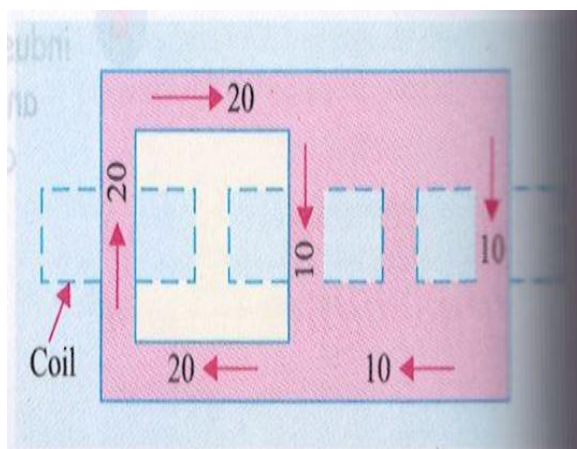
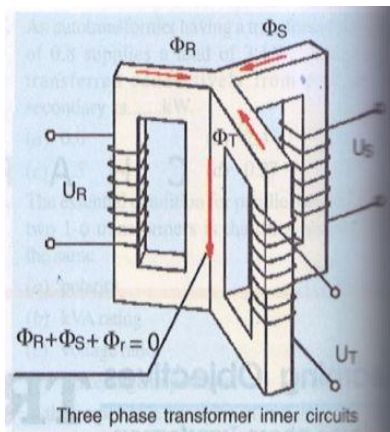

Fig.1.1

Fig.1.2

## Construction

The three phase transformers are also core type and shell type. The basic principle of a three phase transformer is shown in figure.1.1, in which only primary windings have been shown interconnected in star and put across three phase supply. Three cores are  $120^\circ$  apart and their empty legs are shown contact with each other. The centre leg formed by these three carriers the flux produced by the three phase currents  $I_R$ ,  $I_Y$  and  $I_B$ . As at any instant  $I_R + I_Y + I_B = 0$ , hence the sum of three fluxes is also zero. Therefore it will make no difference if the common leg is removed. In that case any two legs will act as their return path for the third Just as in a three phase system any two conductors act as the return for the current in the third conductor.

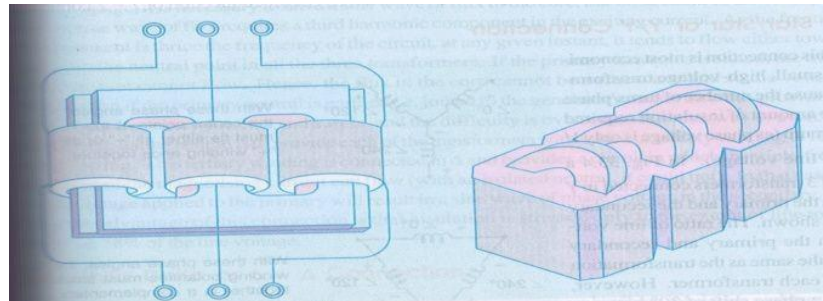

Fig.1.3

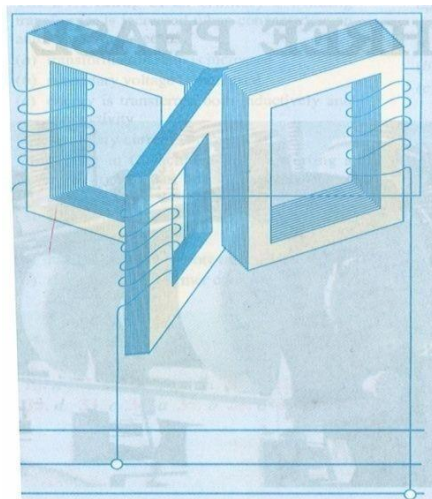

Fig.1.4

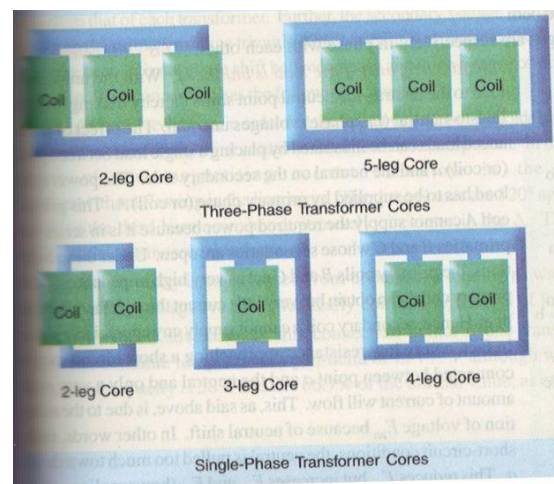

Fig.1.5

## Grouping of the three phase transformer

Three phase transformers are divided into four groups according to their phase displacement between the line voltage on the hv and lv side.

Group1- 0 degree displacement (star-star or delta-delta)

Group2 - 180 degree displacement (star-star or delta-delta but the secondary is reversed)

Group3- +30 degree displacement (sta-delta)

Group4- -30 degree displacement (delta-star)

Thus a connection Yd11 gives the following information

Y indicates that hv is connected in star

d indicates that lv is connected in delta

11 indicate that lv line voltage lags hv line voltage by +30 degree. (Measured from hv phasor in anticlockwise direction).

The phase difference between the hv & lv windings for different types of connection can be represented by comparing it with the hour hand of the clock. When the hour hand of the clock is at 12 O'clock position, the phase displacement is zero. Similarly

Position of hour hand of clock	Phase displacement
0	0°
11	+30°
1	-30°
6	180°

Depending on the phase displacement of the voltages of hv (high voltage) & lv (low voltage) sides, transformers are classified into groups called “Vector group”. Transformer having the same phase displacement between the hv & lv sides are classified into one same group. For successful parallel operation of transformers, they should belong to the same vector group. For example, a star-star connected three phase transformer can be paralleled with another three phase transformer whose windings are either star-star connected or delta-delta connected. A star-star connected transformer cannot be paralleled with another star-delta connected transformer as this may result in short-circuiting of the secondary side.

## Three phase transformer connection

There are various methods available for transforming three phase voltages to higher or lower 3 phase voltages i.e. For handling a considerable amount of power. Usually star connection is used for high voltage transformation and delta connection is used for high current transformation. The most common connection are

1. Y-Y
2.  $\Delta$ - $\Delta$
3. Y- $\Delta$
4.  $\Delta$ -Y
5. Open  $\Delta$  or V-V
6. Scott connection or T-T connection

### Star/Star or Y-Y connection:-

This connection is most economical for small, high voltage transformer because the no of turns per phase and the amount of insulation required is minimum (as phase voltage is only  $1/\sqrt{3}$  of line

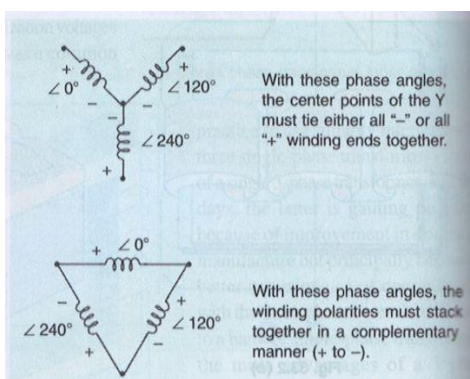

Fig.1.6

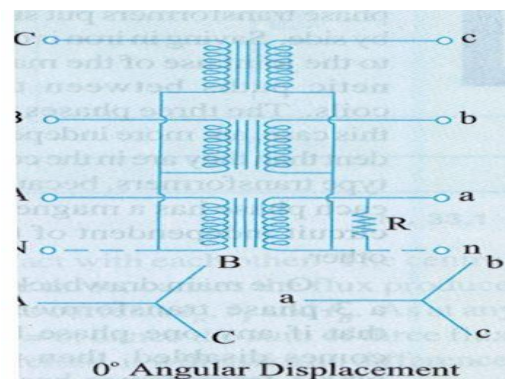

Fig.1.7

-3-

Voltage). In figure 1.7 a bank of three transformers connected in star on both the primary and secondary sides are shown. The ratio of line voltage on the primary and secondary sides is the same as the transformation ratio of each transformer. However there is a phase shift of  $30^\circ$  between the phase voltages and line voltages both on the primary and secondary sides. Of course line voltages on both sides as well as primary voltages are respectively in phase with each other. This connection works satisfactorily only if the load is balanced. With the unbalanced load to the neutral, the neutral point shifts there by making the 3 line- to-neutral

(I.e. phase) voltages unequal. The effect of unbalanced loads can be illustrated by placing a single load between phase (or coil) a and the neutral on secondary side. The power in the load has to be supplied by primary phase (or coil) A. This primary coil A cannot supply the required power because it is in series with primaries B and C whose secondaries are opened. Under these condition the primary coils B and C act as very high impedances so that primary coil A can obtain but very little current through them from the line. Hence secondary coil a cannot supply appreciable power. In fact, a very low resistance approaching a short circuit may be connected between point A and the neutral and only a very small amount of current will flow. This, as said above, is due to the reduction of voltage  $E_{an}$  because of neutral shift. In other words, under short-circuit condition, the neutral is pulled too much towards coil a. This reduces  $E_{an}$  but increases  $E_{bn}$  &  $E_{cn}$  (however line voltage  $E_{AB}$ ,  $E_{BC}$ ,  $E_{CA}$  are unaffected). On the primary side,  $E_{an}$  will be practically reduced to zero whereas  $E_{BN}$  &  $E_{CN}$  will rise to nearly full primary line voltage. This difficulty of shifting (or floating) neutral can be obviated by connecting the primary neutral (shown dotted in the figure) back to the generator so that primary coil A can take its required power from between its line and the neutral. It should be noted that if a single phase load is connected between the lines a and b, there will be a similar but less pronounced neutral shift which results in an over voltage on one or more transformers.

Another advantage of stabilizing the primary neutral by connecting it to neutral of the generator is that it eliminates distortion in the secondary phase voltages. This is explained as follows. For delivering a sine wave of voltage, it is necessary to have a sine wave of flux in the core, but on account of the characteristics of iron, a sine wave flux requires a third harmonic component in the exciting current. As the frequency of this component is thrice the frequency of three circuit, at any given instant of time, it tends to flow either towards or away from the neutral point in all the three transformers. If the primary neutral is isolated the triple frequency current cannot flow. Hence, the flux in the core cannot be a sine wave and so the voltages are distorted. But if the primary neutral is earthed i.e. joined to the generator neutral, then this provides a path for the triple frequency currents and e.m.f.s and the difficulty is overcome. Another way of avoiding this trouble of oscillating neutral is to provide each of the transformers with a third or tertiary winding of relatively low KVA rating. This tertiary winding connected in delta and provides a circuit in which the triple frequency component of the magnetising current can flow (with an isolated neutral, it could not). In this case a sine wave of voltage applied to the primary will result in a sine wave of

phase voltage in the secondary. As said above, the advantage of this connection is that insulation is stressed only to the extent of line to neutral voltage i.e. 58% of the line voltage.

### Delta-Delta or $\Delta$ - $\Delta$ connection:-

This connection is economical for large, low voltage transformers in which insulation problem is not so urgent, because it increases the number of turns/phase. The transformers connection and voltage triangles are shown in fig 1.8 The ratio of transformation between primary and secondary line voltage is exactly the same as that of each transformers. Further, the secondary voltage triangle abc occupy the same relative position as the primary voltage triangle ABC i.e. there is no angular displacement between the two. Moreover, there is no internal phase shift between phase and line voltages on either side as was the case in Y-Y connection. This connection has the following advantages:

-4-

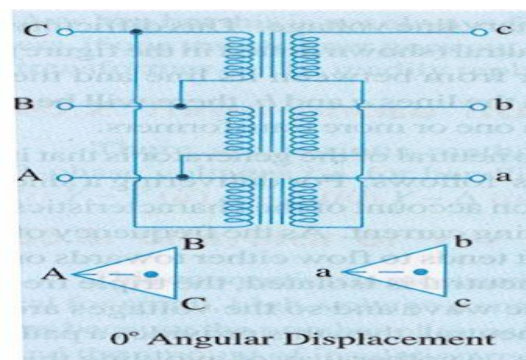

Fig.1.8

- As explained above, in order that the output voltage be sinusoidal, it is necessary that the magnetising current of the transformer must contained a third harmonic component. In this case third harmonic component of the magnetising current can flow in the  $\Delta$  connected transformer primaries without flowing in the line wires. The three phases are  $120^\circ$  apart which is  $3 \times 120^\circ = 360^\circ$  with respect to the third harmonic, hence it merely circulates in the  $\Delta$ . Therefore the flux is sinusoidal which results in sinusoidal voltages.



2. No difficulty is experienced from unbalanced loading as was the case in Y-Y connection. The three phase voltages remain practically constant regardless of load imbalance.

3. An added advantage of this connection is that if one transformer becomes disable, the system can continue to operate in open delta or in V-V although with reduced available capacity. The reduced capacity is 58% and not 66.7% of the normal value as explained in Art.1.9.

#### Wye/Delta or Y- $\Delta$ connection:-

The main use of this connection is at the substation end of the transmission line where the voltage is to be stepped down. The primary winding is Y connected with grounded neutral as shown in fig1.9 the ratio between the secondary and primary line voltage is  $1/\sqrt{3}$  times the transformation ratio of each transformer. There is a  $30^\circ$  shift between the primary and secondary line voltages which means that a Y- $\Delta$  transformer bank cannot be paralleled with either a Y-Y and  $\Delta$ - $\Delta$  bank. Also, a third harmonic current flows in the  $\Delta$  to provide a sinusoidal flux.

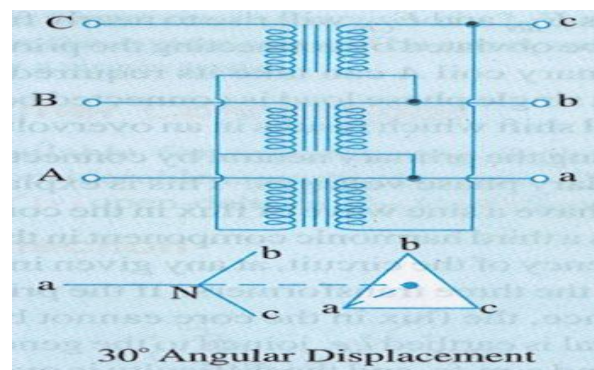

Fig.1.9

#### Delta/Wye or $\Delta$ -Y connection:-

This connection is generally employed where it is necessary to step up the voltage as for example at the beginning of high tension transmission system. The connection is show in fig1.10 the neutral of the secondary is grounded for providing three phase four wire service. In recent years, these connections has gained considerable popularity because it can be used to serve both the three phase power equipment and single phase lighting circuit.



This connection is not open to the objection of a floating neutral and voltage distortion because the existence of a  $\Delta$  connection allows a path for the third harmonic currents. It would be observed that the primary and secondary line voltages and line currents are out of phase with each other by  $30^\circ$ . Because of this  $30^\circ$  shift it is impossible to parallel such a bank with a  $\Delta$ - $\Delta$  and **Y**-**Y** bank of transformers even though the voltage ratios are correctly adjusted. The ratio of secondary to primary voltage is  $\sqrt{3}$  times the transformation ratio of each transformer.

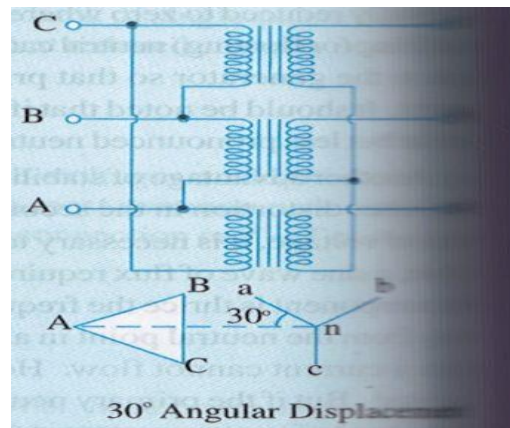

Fig.1.10

**Example 1.1.** A 3 phase, 50 Hz transformer has a delta-connected primary and star connected secondary, the line voltage being 22000 V and 400V respectively. The secondary has a star connected balanced load at 0.8 power factor lagging. The line current on the primary side is 5A. Determine the current in each coil of the primary and in each secondary line. What is the output of the transformer in KW ?

**Solution :** It could be noted that in 3 phase transformer, the phase transformation ratio is equal to the turn ratio but the terminal or line voltages depend upon the method of connection employed. The delta/star connection is shown in figure 1.11 .

Phase voltage on primary side= 22000V

Phase voltage on secondary side=  $400/\sqrt{3}$

$$K = 400/22000 \times \sqrt{3} = 1/55\sqrt{3}$$

Primary phase current =  $5/\sqrt{3}$  A

Secondary phase current=  $(5/\sqrt{3})/K = (5/\sqrt{3})/(1/55\sqrt{3}) = 275$  A

$$\text{Output} = \sqrt{3}V_L I_L \cos\Phi = \sqrt{3} \times 400 \times 275 \times 0.8 = \mathbf{15.24 \text{ KW}}$$

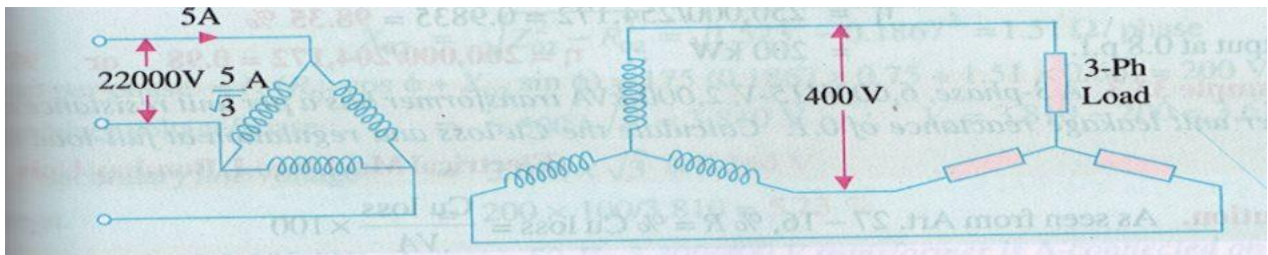

Fig.1.11

**Example 1.2.** A 500KVA, 3 phase, 50 Hz transformer has a voltage ratio (line voltage) of 33/11 KV and is delta/star connected. The resistances per phase are: high voltage 35  $\Omega$ , low voltage 0.876  $\Omega$  and the iron loss is 3050 W. calculate the value of efficiency at full load and  $\frac{1}{2}$  of full load respectively A) at unity P.F. and B) 0.8 P.F.

**Solution:** Transformation ratio (K) =  $11000 / \sqrt{3} \times 33000 = 1/3\sqrt{3}$

$$\text{Per phase } R_{02} = 0.876 + (1/3\sqrt{3})^2 \times 35 = 2.172 \Omega$$

$$\text{Secondary phase current} = 500000 / (\sqrt{3} \times 11000) = 500/11\sqrt{3} \text{ A}$$

**Full load condition :**

$$\text{Full load total Cu loss} = 3 \times (500/11\sqrt{3})^2 \times 2.172 = 4490 \text{ W}$$

$$\text{Iron loss} = 3050 \text{ W}$$

$$\text{Total full load losses} = 4490 + 3050 = 7540 \text{ W:}$$

$$\text{Output at unity P.F} = 500 \text{ KW}$$

$$\text{Full load efficiency} = 500000 / 507540 = 0.9854 \text{ or } \mathbf{98.54 \%}$$

$$\text{Output at 0.8 P.F} = 0.8 \times 500 = 400 \text{ KW}$$

$$\text{Efficiency} = 400000 / 407540 = 0.982 \text{ or } \mathbf{98.2\%}$$

**Half load condition :**

$$\text{Output at unity P.F} = 250 \text{ KW}$$

$$\text{Cu losses} = (1/2)^2 \times 4490 = \mathbf{1,222 \text{ W}}$$

$$\text{Total losses} = 3050 + 1222 = 4172 \text{ W}$$

Efficiency= $250000/254172=0.9835$  or **98.35%**

Output at 0.8 P.F=200 KW

Efficiency=  $200000/204172= 0.98$  or **98%**

### **Open- Delta or V-V Connection.**

If one of the transformers of a  $\Delta$ - $\Delta$  is removed and 3phase supply is connected to the primaries as shown in Fig. 1.12, then three equal 3 phase voltages will be at the secondary terminals on no load. This method of transforming 3-phase power by means of only two transformers is called the open  $\Delta$  or V-V connection.

It is employed:

1. When the three-phase load is too small to warrant the installation of full three phase transformer bank.
2. When one of the transformers in a  $\Delta$ - $\Delta$  bank is disabled, so that service is continued although at reduced capacity, till the faulty transformers is repaired or a new one is substituted.
3. When it is anticipated that in future the load will increase necessitating the closing of open delta.

One important point to note is that the total load that can be carried by a V-V bank is not two-third of the capacity of a  $\Delta$ - $\Delta$  bank but it is only 57.7% of it. That is a reduction of 15% (STRICTLY, 15.5%) from its normal rating. Suppose there is  $\Delta$ - $\Delta$  bank of three 10-kVA transformers. When one transformer removed, then it runs in V-V. The total rating of the transformer kVA rating but only 0.866 of it i.e.  $20 \times 0.866 = 17.32$  (or  $30 \times 0.57 = 17.3 \text{ kVA}$ ). The fact that the ratio of V- capacity to  $\Delta$ - capacity is  $1/\sqrt{3} = 57.7\%$  (or nearly 58%) instead of 66.67 percent can be proved as follows:

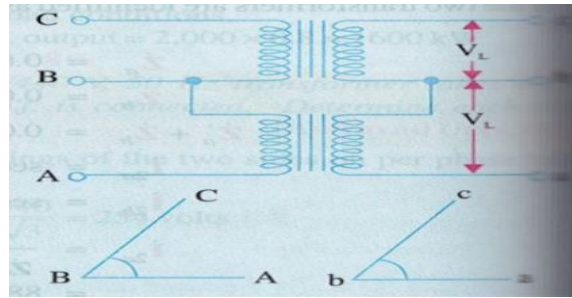

Fig1.12

As seen from fig 1.13(a)

$$\Delta\text{-}\Delta \text{ capacity} = \sqrt{3} \cdot V_L I_L = \sqrt{3} \cdot V_L (\sqrt{3} I_s) = 3 V_L \cdot I_s$$

In Fig1.13 (b) it is obvious that when  $\Delta\text{-}\Delta$  bank becomes V-V bank, the secondary line current  $I_L$  becomes equal to the secondary phase current  $I_s$ .

$$(\text{V-V- capacity} / \Delta\text{-}\Delta \text{ capacity}) = \sqrt{3} \cdot V_L I_s / 3 V_L \cdot I_s = 1/\sqrt{3} = 0.577 \text{ or } 58\%$$

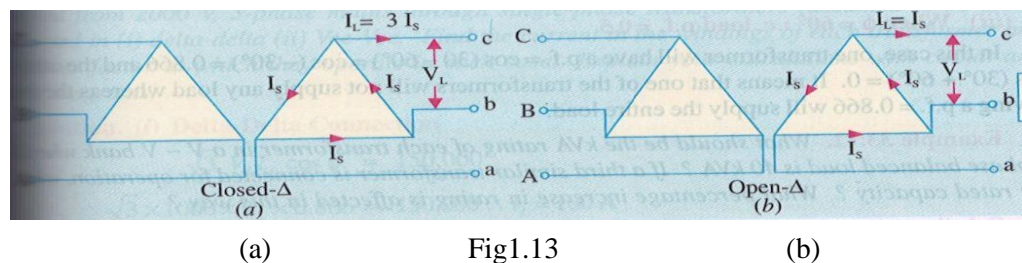

Fig1.13

It means that the 3-phase load which can be carried without exceeding the rating of the transformers is 57.7 per cent of the original load rather than the expected 66.7%. It is obvious from above that when one transformer is removed from a  $\Delta\text{-}\Delta$  bank.

1. The bank capacity is reduced from 30 kVA to  $30 \times 0.577 = 17.3$  kVA and not to 20 kVA as might be thought of.
2. Only 86.6% of the rated capacity of the two remaining transformers is available (i.e.  $20 \times 0.866 = 17.3$  kVA). In other words, ratio of operating capacity to available capacity on an open  $\Delta$  is 0.866. This factor of 0.866 is sometimes called the utility factor.
3. Each transformer will supply 57.7% of load and not 50% when operating in V-V.

However, it is worth noting that if three transformers in a  $\Delta\text{-}\Delta$  bank are delivering their rated load and one transformer is removed, the overload on each of the remaining transformers is 73.2% because

$$(\text{Total load in V-V}) / (\text{VA/transformer}) = \sqrt{3} \cdot V_L I_s / V_L I_s = \sqrt{3} = 1.732$$

This over-load may be carried temporarily but some provision must be made to reduce the load if overheating and consequent breakdown of the remaining two transformers is to be avoided.

The disadvantages of this connection are:

1. The average power factor at which the V-bank operates is less than that of the load, this power factor is actually 86.6% of the balanced load power factor. Another significant point to note is that, except for a balanced unity power factor load, the two transformers in the V-V bank operate at different power factors.
2. Secondary terminal voltages tend to become unbalanced to a great extent when the load is increased, this happens even when the load is perfectly balanced.

It may, however be noted that if two transformers are operating in V-V and loaded to rated capacity in the above example, to 17.3kVA, the addition of a third transformer increases the total capacity by  $\sqrt{3}$  or 173.2% (i.e to 30kVA). it means that for an increase in cost of 50% for the third transformer. The increase in capacity is 73.2% when converting from a V-V system to a  $\Delta$ - $\Delta$  system.

#### Power supplied by V-V connection:

When a V-V bank of two transformer supplies a balanced 3-phase load of power factor  $\cos \phi$ , then one transformer operates at a p.f. of  $\cos(30^\circ - \phi)$  and the other at  $\cos(30^\circ + \phi)$ . Consequently, the two transformers will not have the same voltage regulation.

$$P_1 = \text{KVA} \times \cos(30^\circ - \phi) \text{ And } P_2 = \text{KVA} \times \cos(30^\circ + \phi)$$

i) When  $\phi=0$  i.e. load p.f. =1

Each transformer will have a p.f. =  $\cos 30^\circ = 0.866$

ii) When  $\phi=30^\circ$  i.e. load p.f. =0.866,

In this case, one transformer has a p.f. of  $\cos(30^\circ - 30^\circ) = 1$  and the other of  $\cos(30^\circ + 30^\circ) = 0.866$

iii) ) when  $\phi=60^\circ$  i.e. load p.f.=0.5,

In this case, one transformer has a p.f. of  $\cos(30^\circ - 60^\circ) = \cos(-30^\circ) = 0.866$  and the other of  $\cos(30^\circ + 60^\circ) = \cos(90^\circ) = 0$ . It means that one of the transformers will not supply any load whereas the other having a power factor of 0.866 will supply the entire load.

**Example 1.3.** What should be the kVA rating of each transformer in a V – V bank when the 3 – phase balanced load is 40 kVA? If a third similar transformer is connected for operation, what is the rated capacity? What percentage increase in rating is affected in this way?

**Solution.** As pointed out earlier, the kVA rating of each transformer has to be 15% greater.

$$\text{kVA / transformer} = (40 / 2) \times 1.15 = 23$$

$$\Delta - \Delta \text{ bank rating} = 23 \times 3 = 69; \text{ Increase} = [(69 - 40) / 40] \times 100 = 72.5 \%$$

### Scott Connection or T-T connection:

This is a connection by which 3-phase to 3-phase transformation is accomplished with the help of two transformers as shown in Fig. 1.14. Since it was first proposed by Charles F. Scott, it is frequently referred to as Scott connection. This connection can also be used for 3-phase to 2-phase transformation as explained.

One of the transformers has centre taps both on the primary and secondary ending (Fig.1.14) and is known as the main transformer. It forms the horizontal member of the connection (Fig.1.15).

The other transformer has a 0.866 tap and is known as teaser transformer. One end of both the primary and secondary of the teaser transformer is joined to the centre taps on both primary and secondary of the main transformer respectively as shown in Fig. 1.15(a). The other end A of the teaser primary and the two ends B and C of the main transformer primary are connected to the 3-phase supply.

The voltage diagram is shown in Fig 1.15(a) where the 3-phase supply line voltage is assumed to be 100 V and a transformation ratio of unity. For understanding as to how 3-phase transformation results from this arrangement, it is desirable to think of the primary and secondary vector voltage forming geometrical Ts' (from which this connection gets its name).



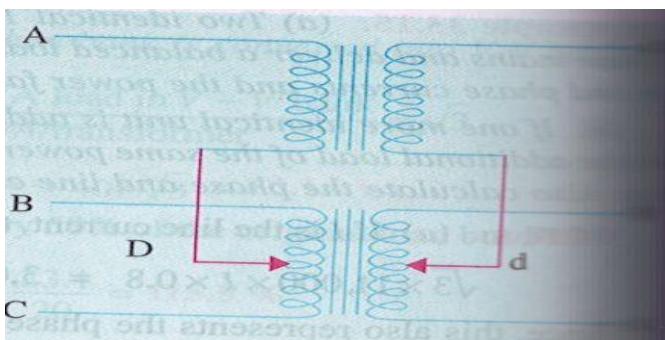

Fig1.14

In the primary voltage T of Fig 1.15(a)  $E_{DC}$  and  $E_{DB}$  are each 50V and differ in phase by  $180^\circ$  because both coils DB and DC are on the same magnetic circuit and are connected in opposition. Each side of the equilateral triangle represents 100 V. The voltage  $E_{DA}$  being the altitude of the equilateral triangle is equal to  $(\sqrt{3}/2) \times 100 = 86.6$  V and lags behind the voltage across the main by  $90^\circ$ . The same relation holds good in the secondary winding so that  $abc$  is a symmetrical 3-phase system.

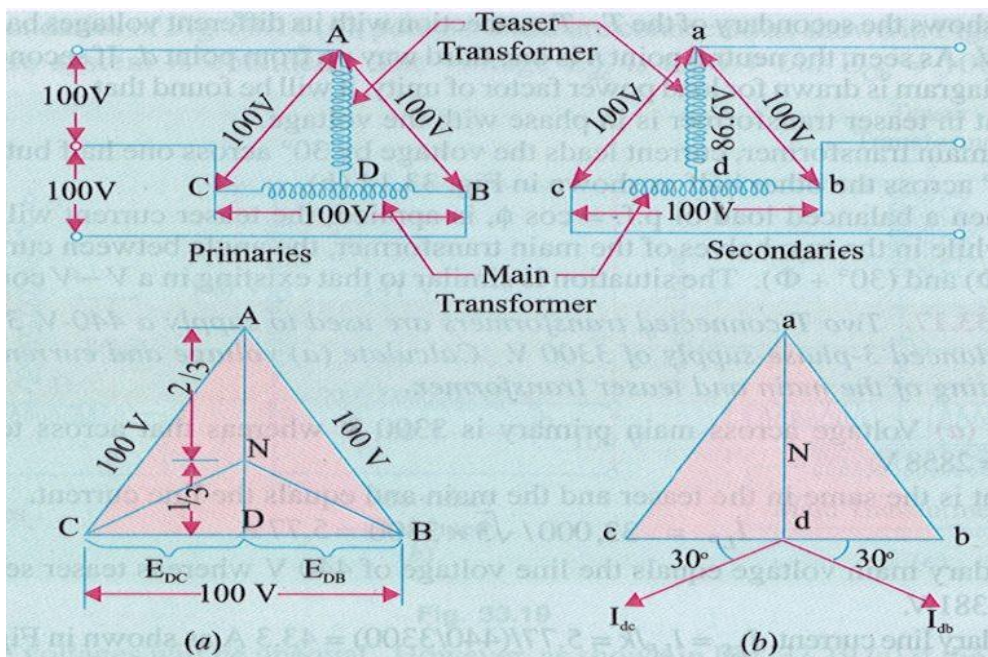

Fig.1.15

With reference to the secondary voltage triangle of Fig. 1.15(b), it should be noted that for a load of unity power factor, current  $I_{db}$  lags behind voltage  $E_{db}$  by  $30^\circ$  and  $I_{db}$  leads

$E_{dc}$  by  $30^\circ$ . In other words, the teaser transformer and each half of the main transformer, all operate at different power factors.

Obviously, the full rating of the transformers is not being utilized. The teaser transformer operates at only 0.866 of its rated voltage and the main transformer coils operate at  $\cos 30^\circ = 0.866$  power factor, which is equivalent to the main transformer's coils working at 86.6 per cent of their kVA rating. Hence the capacity to rating ratio in a T-T. Connection is 86.6% - the same as in V-V connection if two identical units are used, although heating in the two cases is not the same.

If, however, both the teaser primary and secondary windings are designed for 86.6volts only, then they will be operating at full rating, hence the combined rating of the arrangement would become  $(86.6+86.6)/(100+86.6)=0.928$  of its total rating. In other words, ratio of kVA utilized to that available would be 0.928 which makes this connection more economical than open- $\Delta$  with its ratio of 0.866.

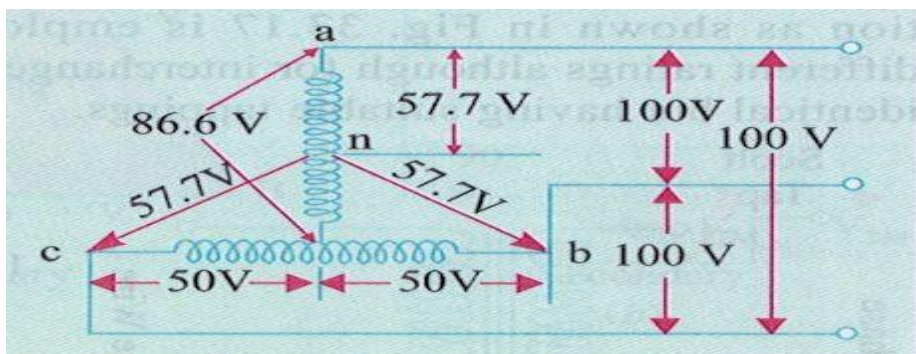

Fig1.16

Fig1.16 shows the secondary of the T-T connection with its different voltages based on a nominal voltage of 100 V. As seen, the neutral point n is one third ways up from point d. If secondary voltage and current vector diagram is drawn for load power factor of unity, it will be found that

1. Current in teaser transformer is in phase with the voltage.
2. In the main transformer, current leads the voltage by  $30^\circ$  across one half but lags the voltage by  $30^\circ$  across the other half as shown in figure 33.15(b)

Hence when a balanced load of power factor  $=\cos\Phi$ , is applied, the teaser current will lag or lead the voltage by  $\Phi$  while in the two halves of the main



transformer, the angle between current voltage will be  $(30^\circ - \Phi)$  and  $(30^\circ + \Phi)$ . The situation is similar to that existing in a V-V connection.

**Example-1.4.** Two T- connected transformers are used to supply a 440V, 33KVA balanced load from a balanced three phase supply of 3300V. Calculate (a) Voltage and current rating of each coil (b) KVA rating of the main and teaser transformer.

**Solution :-** (a) Voltage across main primary is 3300V where as that across teaser primary is  $=0.866 \times 3300 = 2858\text{V}$

The current is the same in the teaser and the main and equals the line current.

$$I_{LP} = 33000 / \sqrt{3} \times 3300 = 5.77\text{A}$$

The secondary main voltage equals the line voltage of 440V whereas teaser secondary voltage  $=0.866 \times 440 = 381\text{V}$

The secondary line current,  $I_{Ls} = I_{LP} / k = 5.77 / (440/3300) = 43.3\text{A}$  as shown in figure 1.17

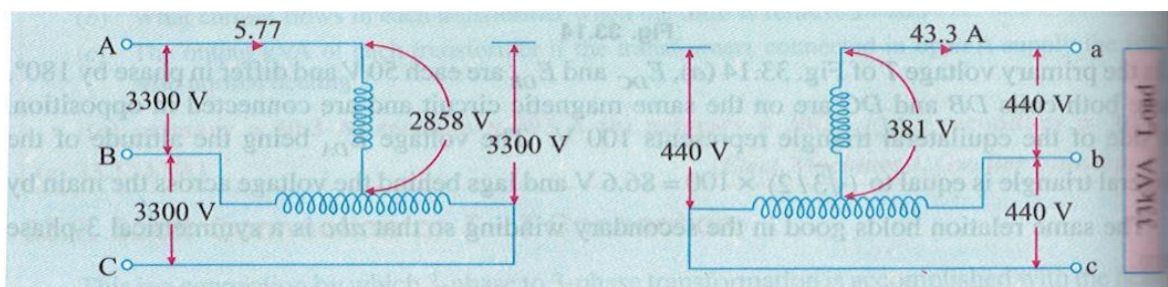

Fig.1.17

(b) Main KVA =  $3300 \times 5.77 \times 10^{-3} = 19\text{KVA}$

Teaser KVA =  $0.866 \times \text{main KVA} = 0.866 \times 19 = 16.4\text{KVA}$

### Three-phase to Two-phase Conversion and vice-versa

This conversion is required to supply two-phase furnaces, to link two-phase circuit with 3-phase system and also to supply a 3-phase apparatus from a 2-phase supply source. For this purpose, Scott connection as shown in fig 1.18 is employed. This connection requires two transformers of different ratings although for interchangeability and provision for spares, both transformers may be identical but having suitable tapings.

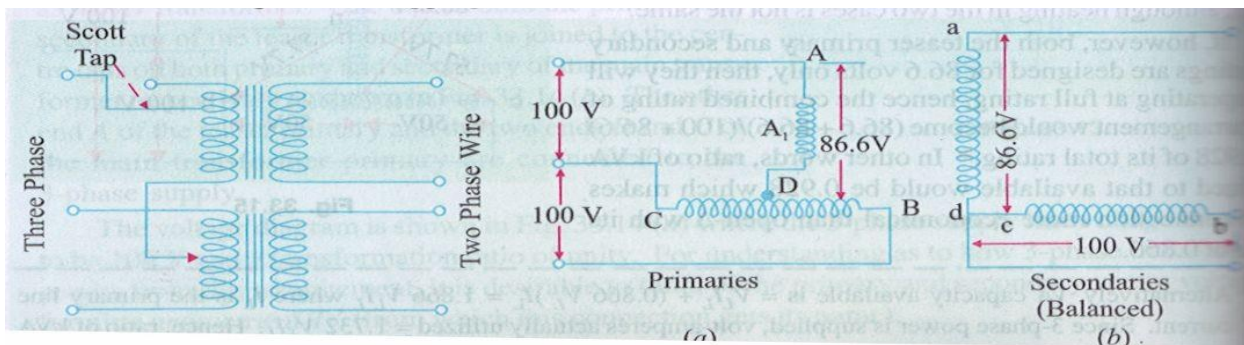

Fig1.18

Fig.1.19

If, in the secondaries of Fig.1.15 (b), points c and d are connected as shown in Fig.1.19 (b), then a 2-phase, 3-wire system is obtained. The voltage  $E_{dc}$  is 86.6 V but  $E_{cb} = 100V$ , hence the resulting 2-phase voltages will be unequal. However, as shown in Fig.1.20 (a) if the 3-phase line is connected to point  $A_1$ , such that  $DA_1$  represents 86.6% of the teaser primary turns (which are the same as that of main primary), then this will increase the volts/turn in the ratio of 100:86.6, because now 86.6 volts are applied across 86.6 percent of turns and not 100% turns. In other words, this will make volts/turn the same both in primary of the teaser and that of the main transformers. If the secondaries are of both the transformers have the same number of turns, then the secondary voltage will be equal magnitude as shown, thus resulting in a 2-phase, 3-wire system.

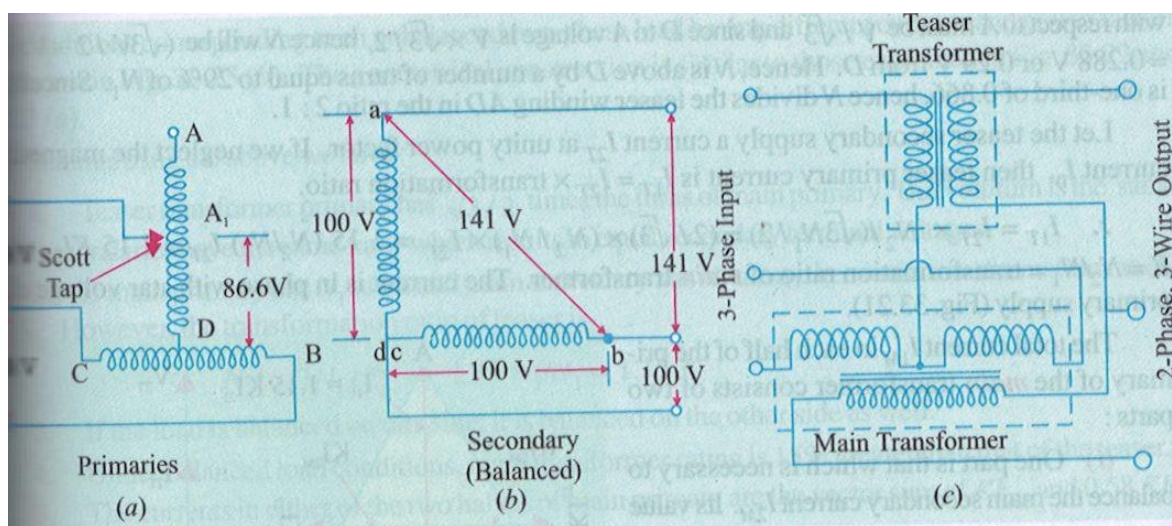

Fig1.20

Consider the same connection drawn slightly differently as in fig.1.21. The primary of the main transformer having  $N_1$  turns is connected between terminals CB of a 3-phase supply. If supply line voltage is  $V$ . then obviously  $V_{AB}=V_{BC}=V_{CA}= V$  but voltage between A and D is  $V \times \sqrt{3}/2$ . As said above, the number of turns between A and D should be  $(\sqrt{3}/2)N_1$

for making volt/turn the same in both primaries. If so, then secondaries having equal turns , the secondary terminal voltages will be equal in magnitude although in phase quadrature.

-12-

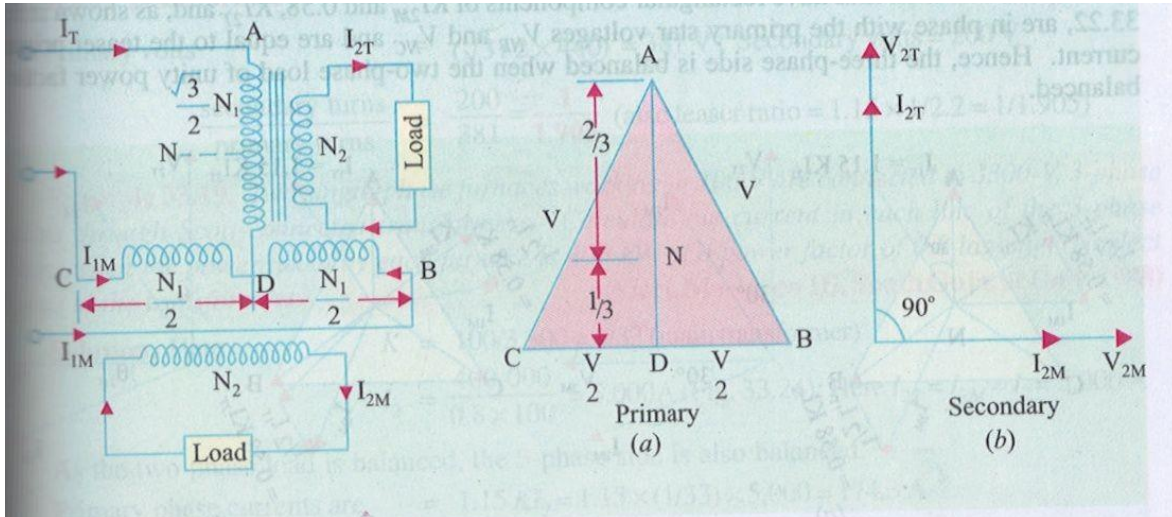

Fig1.21

Fig1.22

It is to be noted that point D is not the neutral point of the primary supply because its voltage with respect to any line is not  $V/\sqrt{3}$ . Let N be the neutral point. Its position can be determined as follows. Voltage N of with respect to A must be  $V/\sqrt{3}$  and since D to A voltage is  $V \times \sqrt{3}/2$ , hence N will be  $\sqrt{3}V/2 - V/\sqrt{3} = 0.288V$  or  $0.29V$  from D. Hence, N is above D by a number of turns equal to 29% of  $N_1$ . Since 0.288 is one third of 0.866, hence N divides the teaser winding AD in the ratio 2:1.

Let the teaser secondary supply a current  $I_{2T}$  at unity power factor. If we neglect the magnetizing current  $I_0$ , then teaser primary current is  $I_{1T} = I_{2T} \times \text{transformation ratio}$

$\therefore I_{1T} = I_{2T} \times N_2 / (\sqrt{3}N_1/2) = (2/\sqrt{3}) \times (N_2/N_1) \times I_{2T} = 1.15 \times (N_2/N_1) \times I_{2T} = 1.15K I_{2T}$  where  $K = N_2/N_1 = \text{transformation ratio of main transformer}$ . The current is in phase with star voltage of the primary supply (figure1.22)

The total current  $I_{1M}$  in each half of the of the primary of the main transformer consists of two parts:

1. One part is that which is necessary to balance the main secondary current  $I_{2M}$ , its value is  $= I_{2M} \times (N_2/N_1) = K I_{2M}$



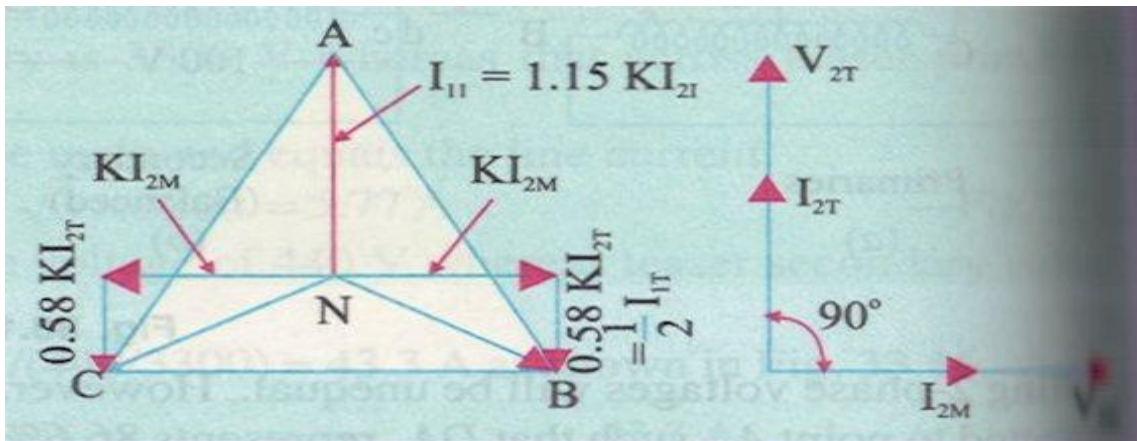

Fig1.23

2. The second part is equal to one half of the teaser primary current i.e.  $0.5 I_{1T}$ . This is so because the main transformer primary forms a return path for the teaser primary current which divides itself into two halves at mid point D in either direction. The value of each half is  $=0.5 I_{1T} = 1.15K I_{2T}/2 = 0.58 K I_{2T}$ .

Hence the current in the lines B and C are obtained vectorially as shown in fig.1.23. It should be noted that as the two halves of the teaser primary current flow in opposite directions from point D, they have no magnetic effect on the core and play no part at all in balancing the secondary ampere-turns of the main transformer.

The line currents thus have rectangular components of  $K I_{2M}$  and  $0.58 K I_{2T}$  and as shown in fig. 1.23, are in phase with primary star voltages  $V_{NB}$  and  $V_{NC}$  and are equal to the teaser primary current. Hence, the three phase side is balanced when the two phase load of unity power factor is balanced.

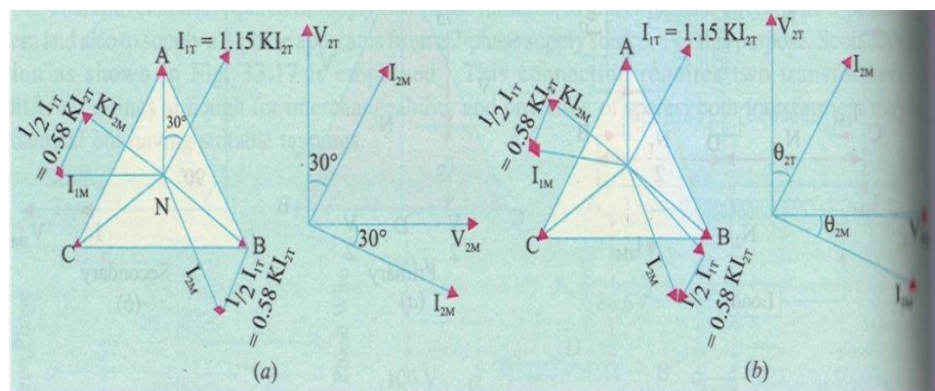

Fig1.24

Figure 1.24(a) illustrates the condition corresponding to a balanced two phase load at a lagging power factor of 0.866. The construction is the same as in figure 1.23. It will be seen that the three-phase side is again balanced. But under these conditions the main transformer rating is 15% greater than that of the teaser, because its voltage is 15% greater although its current is the same.

Hence, *we conclude that if the load is balanced on one side, it would always be balanced on the other side.*

The conditions corresponding to an unbalanced two-phase load having different currents and power factors are shown in figure 1.24(b). The geometrical construction is similar to those explained in figure 1.23 and 1.24(a).

Summarizing the above we have:

1. Teaser transformer primary has  $\sqrt{3}/2$  times the turns of main primary. But volt/turn is the same. Their secondaries have the same turns which result in equal secondary terminal voltages.
2. If main primary has  $N_1$  turns and main secondary has  $N_2$  turns, then main transformation ratio is  $N_2/N_1$ . However, the transformation ratio of teaser is  $N_2/(\sqrt{3} N_1/2) = 1.15 N_2/N_1 = 1.15K$ .
3. If the load is balanced on one side, it is balanced on the other side as well.
4. Under balanced load conditions, main transformer rating is 15% greater than that of the teaser.
5. The currents in either of the two halves of main primary are the vector sum of  $K I_{2M}$  and  $0.58K I_{2T}$  (or  $0.5 I_{1T}$ )

**Example 1.5.** Two transformers are required for Scott connection operating from a 440V, three phase supply for supplying two single phase furnaces at 200V on the two phase side. If the total output is 150KVA, calculate the secondary to primary turn ratio and the winding currents of each transformer.

**Soln: - main transformer**

Primary volts= 440V ∴ secondary volts=200V ∴  $N_2/N_1=200/440=1/2.2$

Secondary current =  $150000/2 \times 200=375 \text{ A}$

Primary current =  $375 \times 1/2.2=197 \text{ A}$

**Teaser transformer**

Primary volts=  $(\sqrt{3}/2 \times 440) = 381 \text{ V}$ : Secondary volts = 200V

Secondary turns /primary turns =  $200/381=0.52$  (also teaser ratio =  $1.15 \times 1/2.2=0.52$ ).

**Parallel operation of three phase transformer**

Transformers are said to be connected in parallel when their primary windings are connected to a common voltage supplier and their secondary windings are connected to a common load.

**Reasons for parallel operation**

1. Extension of loads - for large loads it may be impracticable or uneconomical to have a single large transformer.
2. Capacity to spare – in substations the total load required may be supplied by an appropriate no of transformers of standard size. This reduces the spare capacity of the substation.
3. Future extension - there scope of future extension of a substation to supply a load beyond the capacity of the transformers already installed.
4. If there is a breakdown of transformer in system of transformers connected in parallel, there is no interruption of power supply for essential service. Similarly when a transformer is taken out of service for its maintenance and inspection the continuity of supply is maintained.

### Condition for parallel operation

All the condition which applied to the parallel operation of single phase transformer also is applied to the parallel running of three phase transformer but with the following addition

1. The voltage ratio must refer to the terminal *voltage of primary and secondary*. It is obvious that this ratio may not be equal to the ratio of the number of turns per phase. For example, if  $V_1$ ,  $V_2$  are the primary and secondary terminal voltages, then for Y/ $\Delta$  connection the turn ratio is  $V_2 / (V_1/\sqrt{3}) = \sqrt{3}V_2 / V_1$ .
2. The phase displacement between primary and secondary voltages must be the same for all transformers which are to be connected for parallel operation.
3. Phase sequence must be the same.
4. All the three transformers in the three phase transformer bank will be of the same construction either core or shell.

**Note 1:** IN dealing with three phase transformer calculation are made for one phase only. The value of equivalent impedance used is the impedance per phase referred to secondary.

2. In case the impedance of primary and secondary windings are given separately then primary impedance must be referred to secondary by multiplying it with (transformation ratio)<sup>2</sup>.
3. For Y/ $\Delta$  or  $\Delta$ / Y transformers should be remembered that the voltage ratio as given in the question is referred to terminal voltages and are quite different from turn ratio.

### Tap changers in transformers

The modern equipments, utilising electrical energy are design to operate satisfactorily at one voltage level. It is therefore of paramount importance to keep the consumers' terminal voltage, within the prescribed limits. The transformer output voltage and hence the consumers' terminal voltage, can be controlled by providing taps either on the primary or on the secondary.

The principle of regulating the secondary output voltage is based on changing the number of turns in the secondary quantities.  $V_2 = (N_2 / N_1) \times V_1$ .

If the tap changer is design to operate, when the transformer is out of circuit, it is then called off-load (or no load) tap changer. A tap changer design to operate with the transformer in the circuit is called on load tap changer.

### No load (or off-load) Tap changer

This tap changer is used for seasonal voltage variation. And elementary form of no load tap changer is illustrated in figure.1.25. It has six studs mark from one to six. The winding is tapped at six points equal to the number of studs. The tapping leads are connected to six correspondingly marks stationary studs arranged in circle. The face plate carrying the six studs, can be mounted anywhere on the transformer, say on the yoke or any other convenient place. The rotatable arm R can be rotated by means of hand wheel, from outside the tank.

If the winding is tapped at 2.5% intervals, than with the rotatable arm R

- At studs 1,2: Full winding is in circuit
- At studs 2,3: 97.5% of the winding is in circuit
- At studs 3,4: 95% of the winding is in circuit
- At studs 4,5: 92.5% of the winding is in circuit
- At studs 5,6: 90% of the winding is in circuit

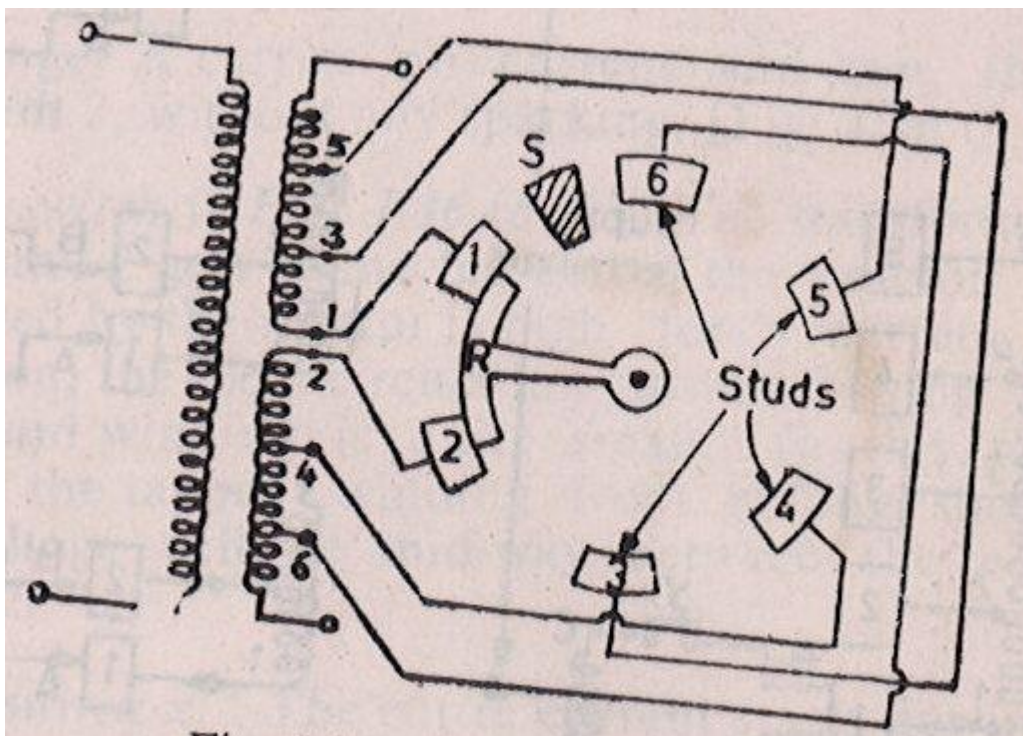



Figure 1.25

Stop S fixes the final position and prevents the arm R from being rotated clockwise. In the absence of stop S, the arm R may come in contact with studs 1 and 6. In such a case, only the lower part of the winding is cut out circuit and this is undesirable from mechanical stress considerations.

The tap changing must be carried out only after the transformer is disconnected from the supply. Suppose arm R is at studs 1, 2. For bringing arm R at studs 2 and 3, the transformer is first de-energised and then arm R is rotated to bridge studs 2 and 3. After this, transformer is switched on to the supply and now 97.5% of the winding remains in circuit.

### On-load tap changer

The tap changer is used for daily or short period voltage alteration. The output voltage can be regulated with the changer, without any supply interruptions. During the operation of an on-load tap changer.

- The main circuit should not be opened otherwise dangerous sparking will occur and
- No part of the tap winding should get short circuited

One form of elementary on load tap-changer is illustrated in figure 1.26(a). The centre tap reactor C prevents the tap from getting short circuited. The transformer tapings are connected to the correspondingly marked segments 1 to 5. Two moveable fingers, A and B connected to centre-tapped reactor via. Switches x and y, make contact with any one of the segments under normal operations.

In fig. 1.26 (a), both the fingers are in contact with segment 1 and full winding is in circuit switches x, y are closed. One half of the total current flows through x, lower half of the reactor and then to the external circuit. It is seen that currents in the upper and lower halves of the reactor flow in opposite direction. Since the whole reactor is wound in the same direction the m.m.f produced by one half is opposite to the m.m.f produced by the secondary half. These m.m.f.s are equal and the net m.m.f is practically zero: therefore the reactor is almost non inductive and the impedance offered by it is very small. Consequently the voltage drop in the centre-tap reactor is negligible.

When a change in voltage is required the finger A and B can be brought to segment to, by adopting the following sequence of operations.

- Open switch y figure 1.26 (b1). The entire current must now flow through the lower half of the reactor. It therefore, becomes highly inductive and there is a large voltage drop. It should be noted that the reactor must be designed to handle full load current, momentarily.
- The finger B carries no current and can therefore, be moved to segment 2, without any sparking (figure 1.26(b2)).
- Close switch Y figure 1.26 (b3) the transformer winding between taps 1 and 2 gets connected across the reactor. Since the impedance offered by the reactor is high for a current flowing in only one direction, the local circulating current flowing through the reactor and tapped winding is quite small. In this manner, the reactor prevents the tapped winding from getting short circuited. The terminal voltage will be mid-way between the potentials of tappings 1 and 2.
- Open switch x: The entire currents start flowing through the upper half of the reactor, manifested by large voltage drop, fig. 1.26 (b4).
- Move the finger A from segment 1 to segment 2 and then close switch x: The winding between taps 1 and 2 is therefore completely out of circuit, fig. 1.26(b5). If further change in voltage is required, the above sequence of operations is repeated.
- For large power transformers the switches x and y may be circuit breakers.

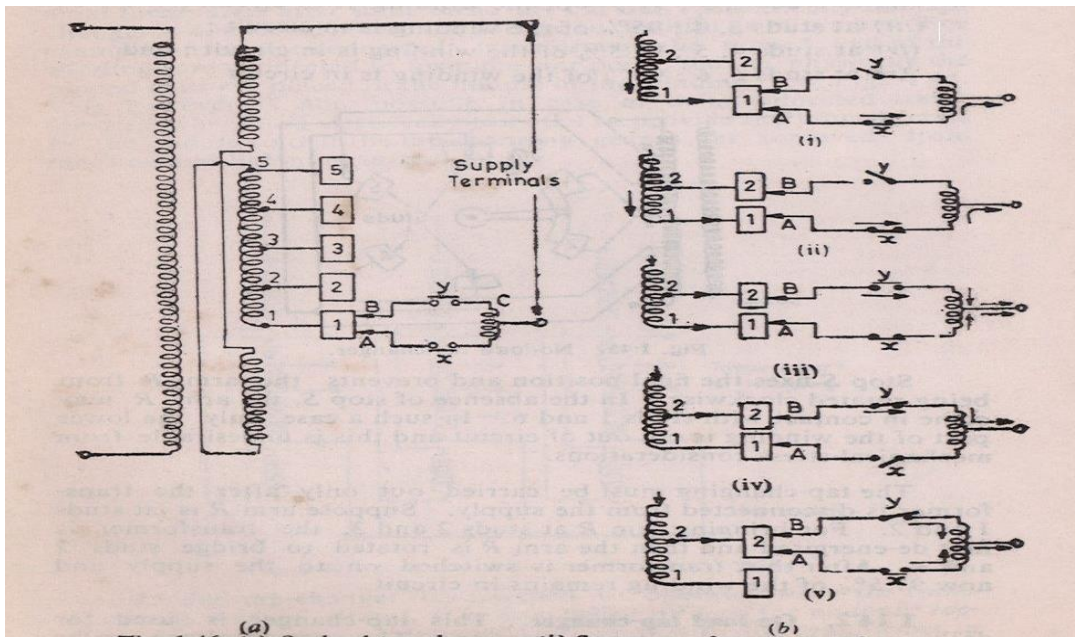

Figure 1.26

### Maintenance of Transformer

The normal life of transformer is about 30 years. It could even be longer if operated carefully and maintained regularly. The main object of maintenance of transformers is to maintain its insulation in good condition. Factors affecting the insulation of a transformer are: moisture, presence of oxygen, and solid impurities.

Maintenance of transformers needs (i) external inspection, and (ii) internal inspection periodically.

The external inspection requires inspection of parts and auxiliaries of the transformer that can be done without opening the tank or lowering the oil level but with the transformer taken out of service, e.g. megger tests, ratio tests, water-flow tests, taking out sample of oil and testing it, inspection of bushings, breathers, oil level, tank, gaskets, ground wire for all auxiliary apparatus, etc. In the case of large transformers, the condition of circulating pumps, on load tapping gears, oil gauges, pressure relief devices, oil gauges, etc., need to be checked.

### Checking and testing of transformer oil

The deterioration of insulation oil is generally due to oxidation, especially when the transformer works under the condition of high temperatures. Oxidation is due to the formation of acids, sludge and water which accompanies the chemical change. Samples of

transformer oil are taken out carefully and tested for colour and odour. Cloudiness in oil may be due to suspended moisture or suspended solid matter. Dark brown colour may indicate dissolved asphalt, green colour dissolved copper compounds; and acid smell indicates the presence of volatile acids.

The oil samples may be tested as follows:

- (a) The dielectric strength of oil should be tested as per IS: 335 – 1953. The oil should withstand the test voltage of at least 30kV for one minute without breakdown.
- (b) Crackle test for free water should be performed as per IS: 335 – 1953. The test is only qualitative.
- (c) The acidity of oil should be determined as per IS: 1866 – 1961.
- (d) Sludge test: The traces of solid matter in oil samples may be examined as per IS: 1866 – 1961.

### **Insulation resistance**

The insulation resistance is measured by megger test along with the temperature. This is because the insulation resistance in megohms gets reduced to nearly half for every 10<sup>0</sup>c temperature rise. The insulation resistance should not be less than two megohms for each 1000 v of operating voltage.

### **Internal inspection of Transformer**

Take samples of oil from top and bottom for testing: Lower oil in transformer. Check inside bushings, brackets, HV, LV windings for damage insulation; check connections, ground of core, insulation condition of various parts, and inside condition. An inspection schedule should be drawn for checks monthly, quarterly and yearly inspection.

### **Maintenance schedule**

**Every hour:** Check temperature of oil, windings, ambient, load & voltage. Adjust load to keep the temperature rise within a permissible limit.

**Daily:** (a) Check oil level; if low, fill in dry oil.

(b) Check the colour of the silica gel in the breather. Colour should be blue. If the colour of the silica gel becomes pink replace them.

**Quarterly:** Check for proper working of cooling fans, circulating pumps, etc.

**Half-yearly:** Check the dielectric strength of oil, bushes, insulators, cable boxes, filter, and replace oil if necessary.

**Yearly:** Check oil for acidity, sludge formation, contacts, lightning arrestors, etc.

Check alarms, relays, etc.

Check earth resistance.

**Five yearly:** Carry out overall inspection of the transformer including lifting of core and coils. Clean the transformer with dry transformer oil.

### 1.24 Diagnostic tests for power Transformer

The Transformer is the heart of the Grid S/S & it is the most costly equipment in it. Any failure in it will not only damage the equipment nearby & may also create danger to the life of the Operating staff. It takes a lot of time to replace a power Transformer, which will affect the steady power supply. Hence it becomes very essential to ascertain the condition of the Transformer under service. The monitoring of Transformer's condition is not that simple as it sounds. Because no test give a very clear picture about the condition. So to ascertain the real condition of the Transformer diagnostic analysis has to be done from a set of results. This is known as diagnostic analysis of a power Transformer.

Normally every utility make some routine tests at least annually to the transformer. Any slight deviation in the routine test, diagnostic analysis may refer to. Even this analysis is essential at a new condition for signature impression as well as to detect any design or assembly defect. The total life of the Transformer may be divided in three segments. The initial period, which is a small period usually 4 to 5 years, is known as **INFANT MORTALITY**. The percentage of failure is quite high in this period. Any failure in this period attributes to design or assemble failure. The 2<sup>nd</sup> stage which is quite longer period is the **NOMAL PERIOD** & has a very less percentage of failure. In this period attribute to poor maintenance. The 3<sup>rd</sup> period is the **AGEING PERIOD**. Again the percentage of failure increases in this period because of ageing factor of mainly soild insulation used. The Frequency of analysis should be more may be almost in every 2 years. This life cycle characteristic is known as **BATH TUB CHARECTETISTIC** because of shape.

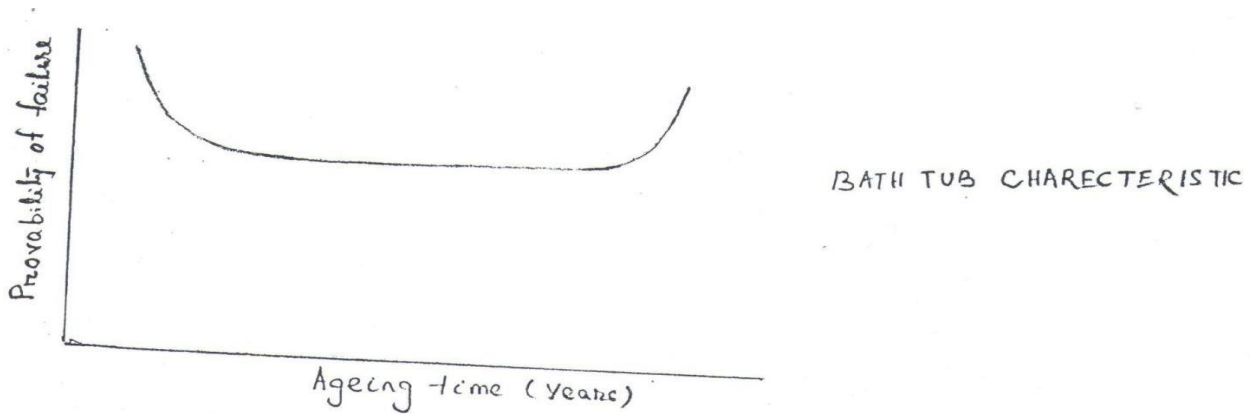

Fig.1.27

The normal routine test that may be conducted atleast every year are;

- IR value.
- PI value.
- Trans value
- BDV Test value.
- However, BDV may be done additionally atleast in every 2 months.
- If any abnormalities are found in the above tests, then only we have to go for dissolved gas analysis (DGA Test), otherwise it is not required.

The life of the Transformer is generally the life of the soild insulation, the cellulosic paper. The degree of deterioration of the insulation is mainly due to the diffrent stress that act on the transformwer under service, which reflects on the life of the transformer used, The stree that act.

- **Mechanical stress:** between conductors, leads & windings due to over currents or fault current, mainly due to system short circuits.
- **Thermal Stress:** Due to local heating, over load currents & leakage flux or due to malfunctioning of cooling system.
- **Dialectric Stree:** System over voltage, Transient impluse condition or due to internal resonance within a winding.
- **Environmental Stress:** Moisture ingress, pollution.

Even may new type of insulation has been developed, the cellulosic paper is still widely used.

The rising temperature in presence of moisture & oxygen accelerate the aging process of the solid insulation, For a example, the paper with 2% moisture ages three times faster than 1% moisture & 30 times faster than 3% moisture content. The degradation product from oil oxidation, such as peroxides & water soluble acid absorbs in paper & makes it brittle & low strength oxycellulose. The oxidation gradually depletes the natural oxidation inhibitors present in naphthalenic oil & products are acid, ketones, peroxides, soap, and aldehyds. This causes colloidal contamination in the oil which form hydrocarbon which again polymerises to form partly conducting sludge & get deposited on the windings thus it makes heat transfer more difficult & oxidation become more faster due to rise of temperature, So it is conclusive that presence of moisture & oxygen in oil or paper is the main culprit to reduce life of the transformer. The routine test must be conducted regularly to know the presence of the moisture & whether it is within the limit or not. If the value is low then there is no problem otherwise we have to go for further analysis regarding the presence of moisture & other conducting gases & where it is present (whether in oil or in paper or in both). Accordingly steps will be taken. The oxidations also accelerate due to partial discharge.

By now our stand is more clear that;

- We want to know whether any moisture or any conducting soluble gas or conducting particulars present in the insulation.
- If present not within limit then it is essential to know where it is and in which form and how to separate it out & to increase the life period.
- We should not allow to increase the moisture content in oil and if however it has entered then it is essential to know to what level the damage has been taken place. So that we can decrease the effect to certain level and increase the life of our transformer.

### 1.25. Routine test

#### (1) IR value:

It is simply the insulation resistance of the insulating materials i.e. paper & oil in combination, A DC potential is applied usually 5 KV between different windings, between winding & tank of the transformer. Earlier, the value was noted after allowing the current for 15 sec. But now a day value is noted after 1 min. As the real values can be known only after allowing the current for certain time. What should be the IR Value? It is a real debate. It

depends upon the size & shape of the insulating materials & also affected by different environmental condition. In a thumb rule people consider it as  $1.5 \text{ M}\Omega/\text{KV}$ . If there is any huge variation then it is generally marked, Before taking the IR value all clamps & connectors should be properly tightened & bushing & tanks should be cleaned. This test has least importance unless & until the value is out right low.

## (2) PI Value:

It is known as polarisation index. It is a number having no unit. It is a ratio of insulation resistance value taken for 10 min. to 1 min. Now the question arises what is polarisation & how its value is affected due to the presence of moisture or any conducting soluble gas.

In a conductor there is free electron, which is free to move under application of external field, but in case of insulator there is no free electron. At normal condition the electron moves around the protons such that CG of both consider with each other, has no net polar effect, when an external field is applied the rotation of the electron around the proton is no more circular but eccentric as shown in the figure.

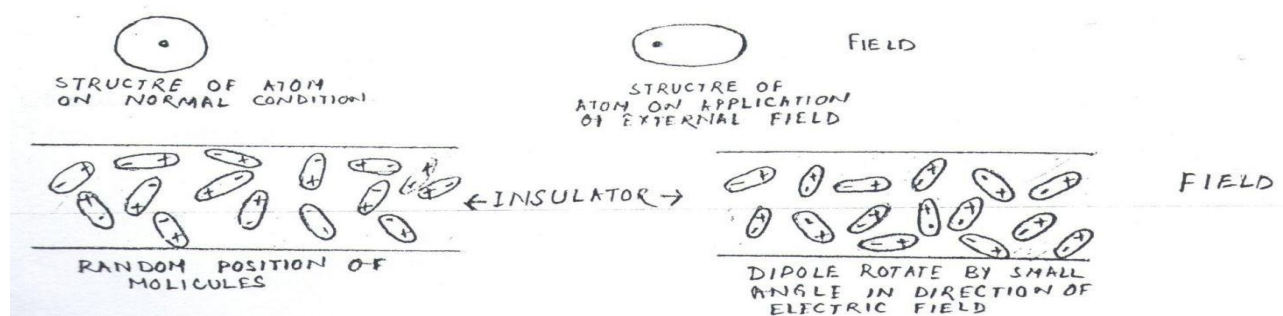

Fig.1.28

This implies when an electrical field is applied the CG of proton & electron are no more same but displaced with a small gap. This result into a electrical dipole or it can be said that polarisation has taken place. This dipoles orient around itself in such a manner that the net electrical field produced by the dipoles, opposes the applied electrical field. The reduction in applied field reduces the current or increase the resistance values. The increasing value is more & more as more & more dipole oriented around itself. After around 10min almost all orientation takes place so 10 min values is taken. The polarisation index has a other name that is **DRYNESS FACTOR**.



The name suggests that the dryness of the insulation has a certain role over that ratio which is known as polarisation index. If there is some moisture or desolve conducting gases present in a insulator then a conduction sphere appears around the insulator which does not allow to penetrate the external field. This reduces the polarisation effect. So reduction & PI value indicates the presence of moisture or any desolve conducting gases in the insulator, as per IS the value above 1.5 is consider to be good.

### 3) Tan $\delta$ value:

The PI value is affectec by moisture & desolve gases but there may be many other conducting non soluble substances which allowed more current to flow to the insturator causing more heat & oxidation. Thus causing deterioration of insulating materials. Tan  $\delta$  test gives more clear-cut picture regarding the presence of any conducting materials presence in the insulator.

When a insulator is in between two conducting substances it is nothing but a capacitor. So when we apply a AC potential between two winding or winding & tank which is earthed acts as a capacitive circuit as both solid & liquid insulator are in between. Ideally the current should lead the voltage by an angle of  $90^0$ . But practically it will not beacause of certain resistance present in it. The angle by which it falls to reach  $90^0$  is known as  $\delta$  angle.

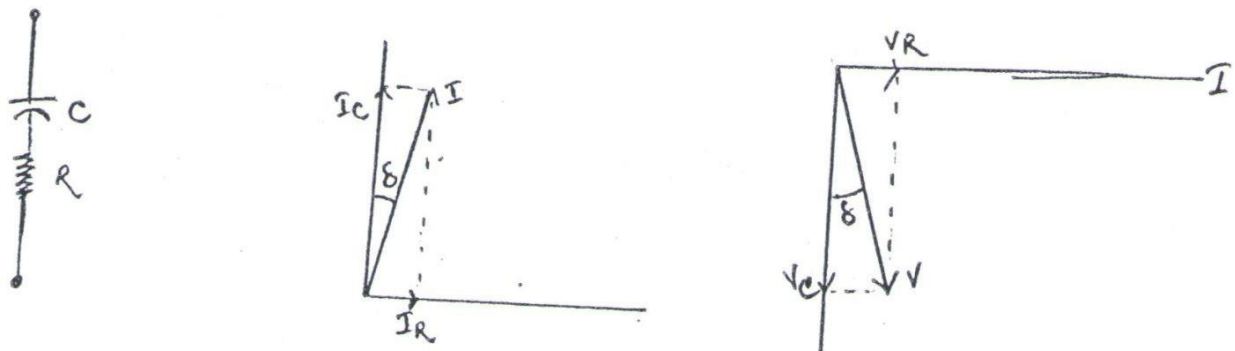
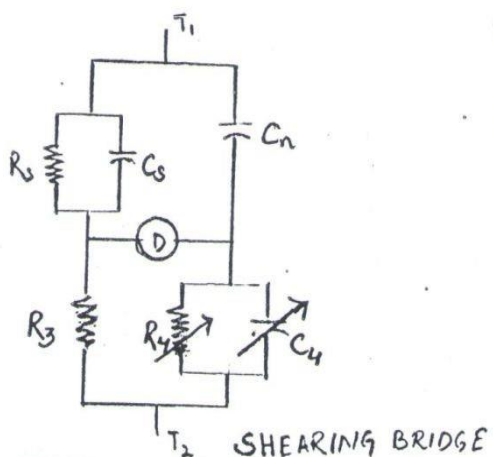

Fig.1.29

$$\text{Tan}\delta = V_R / V_C = R / X_C$$

Higher is the value of Tan $\delta$ , more is the resistive materials present in the insulation in any form as per value upto 0.2 allowed.

To major the Tan $\delta$  value the instrument used is nothing but a Sheraing bridge, supported by a software to give the result directly in Tan $\delta$ .



Under balance condition  
 $Z_1/Z_3 = Z_2/Z_4$   
 Equating real & imaginary part  
 $C_5 = \frac{C_n \times R_4}{R_3}$  &  $R_5 = \frac{R_3 \times C_4}{C_n}$   
 $\tan \delta = \omega \times \left( \frac{C_n \times R_4}{R_3} \right) \times \left( \frac{R_3 \times C_4}{C_n} \right)$   
 $= \omega R_4 C_4$   
 $R_5$  &  $C_5$  to be calculated that of transformer  
 all other values are known.

Fig.1.30

**4) BDV Test value:**

It is a very simple test. The breakdown voltage (BDV) of an insulator is the potential at which it loses its insulating property & become conducting. Oil is taken in a glass or plastic container of usually 300ml to 500ml capacities. The electrode are of copper, brass bronze or stainless steel well polished having spherical shape of dia 12.5mm to 13mm separated by  $2.5 \pm 0.1$ mm.

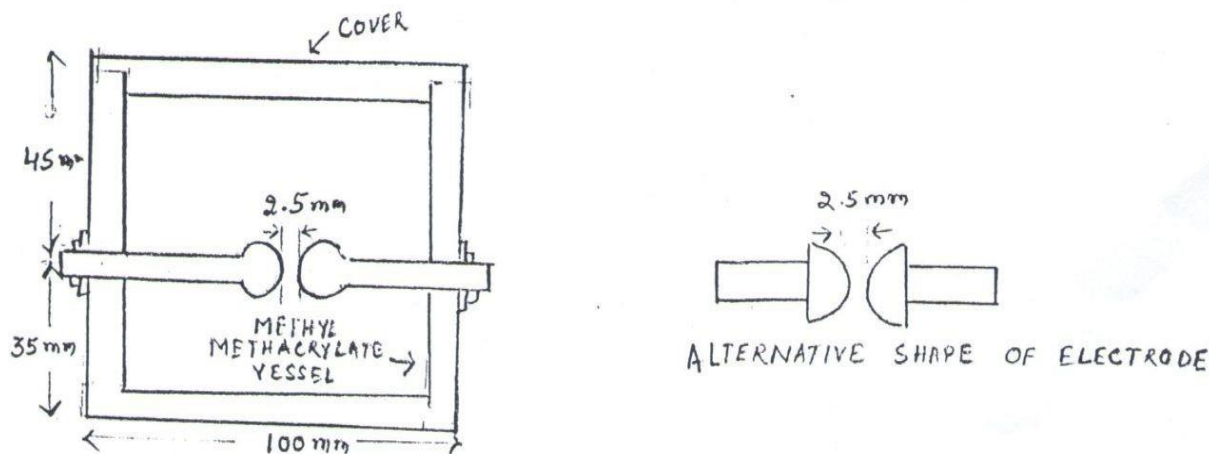

Fig.1.31

The oil under test should be between  $15^{\circ}\text{C}$  to  $35^{\circ}\text{C}$  preferably  $27^{\circ}\text{C}$ . The applied potential at rated frequency should be raised gradually at a rate around 2KV per sec till flash over takes place. The test kits automatically switch OFF within 0.02sec, The average of six tests result is taken. The time interval between two tests should be 5min. if the disappearance of air bubble does not take place. The value recommended by IS is above 50KV. This test

may be taken in every month. Proper care should be taken at sampling time; so that no external moisture enters to it.

### SUMMARY

BDV	>50KV	Good.
	<50KV	Should be taken again in a better weather condition & if it is still low, then filtration or dehydration may be required & will be decided after other tests.
PI	>1.5	Good.
	<1.5	Filtration or dehydration may be required & will be decided after other tests.
Tan $\delta$	<0.2	Good.
	>0.2	Filtration or dehydration may be required & will be decided after other tests.

#### **Other Test:**

- 1) IR, PI & Tan $\delta$ .
- 2) Test on Oil & DGA.
- 3) Recovery Voltage Measurement.
- 4) Dielectric Spectroscopy Test.
- 5) Magnetic Balance Test.
- 6) Turns Ratio Test.
- 7) Frequency Response Analysis.
- 8) Coil Resistance Test.
- 9) Degree of polymerisation Test. (DP)
- 10) Partial Discharge Test (PD)
- 11) Surge Voltage Analysis Test.