

# **LECTURE NOTES ON**

## **Electrical Installation and Estimating**

**For**

**6<sup>th</sup>sem, Electrical Engg. (Diploma)**

**Prepared by:**

**Lect.Umesh ch. Sethi**

**(GF in Electrical Engg.)**

## **BASICS OF ESTIMATING**

Estimating is an art by which an estimator can get an approximation of the material, investment involved and the time to be taken for the completion of electrification project. By estimating the material cost and the time required for completion of electrification project we can get help in making right and firm decision while making a contract with any firm but it is a report prepared on estimating.

A good estimating have the following parameter

1. Estimating the quantity of material and cost involved
2. Analysis of cost or selling price
3. Maintaining proper accounts
4. Provision of selling aids.

## **PURPOSE OF ESTIMATING AND COSTING**

It is necessary to know the required material and the cost to be incurred on it before starting a new project and also prepared a complete project report. It is very necessary bcz it gives the amount of money required, availability of material. To purchase material from market, a market survey is required.

## **QUALITIES OF A GOOD ESTIMATOR**

1. Estimator should have complete knowledge and practical experience about estimation.
2. An estimator should have good imagination and experimenting power and have updated knowledge.
3. An estimator should go to the work place time to time for inspecting the project work.
4. A good estimator should always keep for future extension while estimating a project.
5. An estimator should keep up-to-date knowledge of prices of material that available in market.

## **ESSENTIAL ELEMENT OF ESTIMATING AND COSTING**

Before any electrical project initiated, the knowledge of material required for the project and the estimate and cost involved is essential while preparing design and list of material required for the project. The following elements are required.

1. Specification of material
2. Latest market cost of material
3. Price list and net prices
4. Calculation of material and labor cost
5. Knowledge of purchase system
6. Labor Cost

## **OTHER IMPORTANT FACTOR OF ESTIMATING AND COSTING**

1. Contingencies
2. Overhead Charges
3. Supervision charges
4. Production cost
5. Profit
6. Storage charges
7. Tools and plant charges
8. Total cost

## **INDIAN ELECTRICITY RULE**

Definitions-

(1) In these rules, unless the context otherwise requires, -

(a) “**The Act**” means the Indian Electricity Act, 1910;

These rules may be called the Indian Electricity Rules, 1956.

(2) They shall come into force at once.

**AMPERE:** “Ampere” means a unit of electric current and is the unvarying electric current which when passed through a solution of nitrate of silver in water.

**APPARATUS:** “Apparatus” means electrical apparatus and includes all machines, fittings, accessories and appliances in which conductors are used.

**ACCESSIBLE:** “Accessible” means within physical reach without the use of any appliance or special effort;

**BARE:** “Bare” means not covered with insulating materials.

**CABLE:** “Cable” means a length of insulated single conductor (solid or stranded or of two or more such conductors, each provided with its own insulation, which are laid up together. Such insulated conductor or conductors may or may not be provided with an overall mechanical protective covering.

**CIRCUIT:** “Circuit” means an arrangement of conductor or conductors for the purpose of conveying energy and forming a system or a branch of a system.

**CONDUCTOR:** “Conductor” means any wire, cable, bar, tube, rail or plate used for conducting energy and so arranged as to be electrically connected to a system.

**CONDUIT:** “Conduit” means rigid or flexible metallic tubing or mechanically strong and fire resisting non-metallic tubing into which a cable or cables may be drawn for the purpose of affording it or them mechanical protection.

**DANGER:** “Danger” means danger to health or danger to life or any part of body from shock, burn or other injury to persons, or property, or from fire or explosion, attendant upon the generation, transmission, transformation, conversion, distribution or use of energy.

**DEAD:** “Dead” means at or about earth potential and disconnected from any live system.

**NOTE-** The term “dead” is used only with reference to current carrying parts when these parts are not live.

**CUT OUT:** “Cut-out” means any appliance for automatically interrupting the transmission of energy through any conductor when the current rises above a predetermined amount, and shall also include fusible cutout.

**EARTHING SYSTEM:** “Earthing system” means an electrical system in which all the conductors are earthed.

**LIVE:** “Live” means electrically charged

**SPAN:** “Span” means the horizontal distance between two adjacent supporting points of an overhead conductor.

**SWITCH GEAR:** “Switchgear” shall denote switches, circuit breakers, cut-outs and other apparatus used for the operation, regulation and control of circuits.

**VOLT:** “Volt” means a unit of electromotive force and is the electric pressure, which, when steadily applied to a conductor, the resistance of which is one ohm, will produce a current of one ampere

**VOLTAGE:** “Voltage” means the difference of electric potential measured in volts between any two conductors or between any part of either conductor and the earth as measured by a suitable voltmeter and is said to be;

“**Low**” where the voltage does not exceed 250 volts under normal conditions subject, however, to the percentage variation allowed by these rules.

“**Medium**” where the voltage does not exceed 650 volts under normal conditions subject, however, to the percentage variation allowed by these rules.

“**High**” where the voltage does not exceed 33,000 volts under normal conditions subject, however, to the percentage variation allowed by these rules.

“**Extra high**” where the voltage exceeds 33,000 volts under normal conditions subject, however, to the percentage variation allowed by these rules.

### **GENERAL SAFETY PRECAUTION RULE**

To install electrical equipment or work on any electrical equipment safely in the workplace, **general electrical safety rules** must be followed according to **Indian Electricity Rule 1956**, revised in 2020, to prevent electrical incidents.

**RULE-29:** All electric supply lines and apparatus shall be of sufficient ratings.

**RULE-30:** Power supply lines, wires, accessories and devices must be kept in a safe condition and suitable in all respects for the supply of energy and free from any danger.

**RULE-32:** The earthed and grounded neutral conductor and the position of switches and circuit breakers must be appropriately identified.

**RULE-33:** A suitable earth terminal must be provided and maintained in an accessible position at or near the start point of the supply.

**RULE-34:** Wherever bare conductors are used, they should be inaccessible and fitted with switches in an easily accessible position to make them dead whenever necessary.

**RULE-35:** A danger notice in Hindi or English and the local language with a skull and bone sign (as specified in IS No. 2551) must be permanently affixed on all medium, high and very high voltage installations.

**RULE-36:** No one shall work on a live electrical power line or device and no one shall assist such a person on such work, unless he is authorized to do so.

Anyone working on an electrical power line or device or both must be provided with tools and safety devices such as gloves, rubber shoes, seat belts, ladders, grounding devices, helmets, line testers, hand lamps, etc. to protect it against mechanical or electrical injury.

**RULE-40:** Street boxes should not contain gas lines and precautions should be taken to prevent any influx of water or gas. All street boxes should be inspected regularly for the presence of gas.

**RULE-41:** Any power plant, substation, junction box, pillar or supply pole in which a circuit or device is located must be distinguished from one another by means of a permanent identification.

**RULE-43:** Adequate arrangements for fighting electrical fires must be installed and maintained. A first aid kit and personal protective equipment must be available in sufficient quantity.

**RULE-44:** Instructions for catering for people with electric shock should be posted in English or Hindi and the local language in prominent places. An artificial respirator must be provided and maintained in good working order in each inhabited high voltage or very high voltage power plant.

**RULE-45:** Contractors licensed by the state government should only be deployed to perform all electrical installation work, including additions, modifications, repairs and adjustments to existing installations.

**RULE-46:** All electrical installations should be tested and inspected at periodic intervals not to exceed five years by a licensed electrical inspector.

**GENERAL CONDITION TO RELATING TO SUPPLY AND USE OF ENERGY**

**IER-47:** Testing of consumer's installation-Upon receipt of an application for a new or additional supply of energy and before connecting the supply or reconnecting the same after a period of six months, the supplier shall inspect and test the applicants' installation.

**IER-48: Precautions against leakage before connection-**

- (i) High Voltage Equipments installations- (a) High Voltage equipments shall have the IR value as stipulated in the relevant Indian Standard. (b) At a pressure of 1000 V applied between each live conductor and earth for a period of one minute the insulation resistance of HV installations shall be at least 1 Mega ohm or as specified by the 1 [Bureau of Indian Standards] from time to time.
- (ii) Medium and Low Voltage Installations- At a pressure of 500 V applied between each live conductor and earth for a period of one minute, the insulation resistance of medium and low voltage installations shall be at least 1 Mega ohm or as specified by the 2 [Bureau of Indian Standards from time to time.

**IER-49: Leakage on consumer's premises-**

**IER-50: Supply and use of energy-**The energy shall not be supplied, transformed, converted or used or continued to be supplied, transformed, converted or used unless provisions as set out below are observed

- (i) A linked switch with fuse(s) or a circuit breaker by low and medium voltage consumers.
- (ii) A linked switch with fuse(s) or a circuit breaker by HV consumers having aggregate installed transformer/apparatus capacity up to 1000 KVA to be supplied at voltage upto 11 KV and 2500 KVA at higher -voltages (above 11 KV and not exceeding 33 KV).
- (iii) A circuit breaker by HV consumers having an aggregate installed transformer/apparatus capacity above 1000 KVA and supplied at 11 KV and above 2500 KVA supplied at higher voltages (above 11 KV and not exceeding 33 KV).
- (iv) A circuit breaker by EHV consumer.

**IER-51:** Provisions applicable to medium, high or extra-high voltage installations The following provisions shall be observed where energy at medium, high or extra high voltage is supplied, converted, transformed or used.

**IER-54: Declared voltage of supply to consumer.** - Except with the written consent of the consumer or with the previous sanction of the State Government a supplier shall not permit the voltage at the point of commencement of supply as defined under rule 58 to vary from the declared voltage-

- (i) In the case of low or medium voltage, by more than 6 per cent, or;
- (ii) In the case of high voltage, by more than 6 per cent on the higher side or by more than 9 per cent on the lower side, or;
- (iii) In the case of extra-high voltage, by more than 10 per cent on the higher side or by more than 12.5 per cent on the lower side.

**IER-55:** Declared frequency of supply to consumer- Except with the written consent of the consumer or with the previous sanction of the State Government a supplier shall not permit the frequency of an alternating current supply to vary from the declared frequency by more than 3 per cent.

**IER-56: Sealing of meters, and cut-outs-**

**IER-57: Meters, maximum demand indicators and other apparatus on consumer's premises-**

**IER-58:** Point of commencement of supply- The point of commencement of supply of energy to a consumer shall be deemed to be the point at the incoming terminal of the cut-outs installed by the consumer under rule 50.

**IER-59: Precautions against failure of supply: Notice of failures-**

**IER-60: Test for resistance of insulation-**

**IER-61: Connection with earth-**

**IER-62: Systems at medium voltage-** Where a medium voltage supply system is employed, the voltage between earth and any conductor forming part of the same system shall not, under normal conditions, exceed low voltage.

## **HIGH VOLTAGE SYSTEM**

### **IER-63: Approval by Inspector-**

### **IER-64: Use of energy at high and extra-high voltage-**

### **IER-65: Testing, Operation and Maintenance-**

### **IER-66: Metal sheathed electric supply lines.**

The conductors shall be enclosed in metal sheathing which shall be electrically continuous and connected with earth, and the conductivity of the metal sheathing shall be maintained and reasonable precautions taken where necessary to avoid corrosion of the sheathing.

**IER-67:** Connection with earth-All non-current carrying metal parts associated with HV/EHV installation shall be effectively earthed to a grounding system

### **IER-68: General conditions as to transformation and control of energy-**

Where energy at high or extra-high voltage is transformed, converted, regulated or otherwise controlled in substations or switch-stations (including outdoor substations and out-door switch-stations) or in street boxes constructed underground,

**IER-70:** Condensers- Suitable provision shall be made for immediate and automatic discharge of every static condenser on disconnection of supply.

## **OVERHEAD LINE**

### **IER-74: Material and strength-**

All conductors of overhead lines other than those specified in sub-rule

(1) of rule 86 shall have a breaking strength of not less than 350 kg.

(2) Where the voltage is low and the span is of less than 15 metres and is on the owner's or consumer's premises, a conductor having an actual breaking strength of not less than 150 kg may be used.

**IER-75:** Joints-Joints between conductors of overhead lines shall be mechanically and electrically secure under the conditions of operation. The ultimate strength of the joint shall not be less than 95 per cent of that of the conductor, and the electrical conductivity not less than that of the conductor.

### **IER-76: Maximum stresses: Factors of safety-**

The owner of every overhead line shall ensure that it has the following minimum factors of safety:-

- (i) For metal supports -1.5 (ii) For mechanically processed concrete supports- 2.0 (iii) For hand-moulded concrete supports -2.5 (iv) For wood supports- 3.0.

### **IER-77: Clearance above ground of the lowest conductor-**

(1) No conductor of an overhead line, including service lines, erected across a street shall at any part thereof be at a height of less than-

(a) For low and medium voltage lines -5.8 metres (b) For high voltage lines- 6.1 metres

(2) No conductor of an overhead line, including service lines, erected along any street shall at any part thereof be at a height less than-

a) For low and medium voltage lines -5.5 metres (b) For high voltage lines- 5.8 metres

(4) For extra-high voltage lines the clearance above ground shall not be less than 5.2 metres plus 0.3 metre for every 33,000 volts or part thereof by which the voltage of the line exceeds 33,000 volts. Provided that the minimum clearance along or across any street shall not be less than 6.1 metres

**IER-78: Clearance between conductors and trolley wires-**(a) Low and medium voltage lines -1.2 metres.

### **IER-79: Clearances from buildings of low and medium voltage lines and service lines-**

(1) Where a low or medium voltage, overhead line passes above or adjacent to or terminates on any building, the following minimum clearances from any accessible point, on the basis of maximum sag, shall be observed: -

(a) For any flat roof, open balcony, verandah roof and lean-to-roof-

(i) When the line passes above the building a vertical clearance of 2.5 metres from the highest point, and (ii)

When the line passes adjacent to the building a horizontal clearance of 1.2 metres from the nearest point, and

(b) For pitched roof-

- (i) When the line passes above the building a vertical clearance of 2.5 metres immediately under the lines, and (ii) When the line passes adjacent to the building a horizontal clearance of 1.2 metres

**IER-80: Clearances from buildings of high and extra-high voltage lines-**

Where a high or extra-high voltage overhead line passes above or adjacent to any building or part of a building it shall have on the basis of maximum sag a vertical clearance above the highest part of the building immediately under such line, of not less than-

- (a) For high voltage lines upto and including 33,000 volts- 3.7 metres (b) For extra-high voltage lines -3.7 metres plus 0.30 metre for every additional 33,000 volts or part thereof.

(2) The horizontal clearance between the nearest conductor and any part of such building shall, on the basis of maximum deflection due to wind pressure, be not less than-

- a) For high voltage lines upto and including 11,000 volts -1.2 metres (b) For high voltage lines above 11,000 volts and up to and including 33,000 volts- 2.0 metres (c) For extra-high voltage lines -2.0 metres plus 0.3 metre for every additional 33,000 volts for part thereof.

**IER-86: Conditions to apply where telecommunication lines and power lines are carried on same supports-**

**IER-87: Lines crossing or approaching each other-**

**IER-88: Guarding-**

**IER-89: Service-lines from Overhead lines-** No Service-line or tapping shall be taken off an overhead line except at a point of support.

**IER-90: Earthing-**

**IER-91: Safety and protective devices-**

**Electrical Wiring system:** A network of wires connecting various accessories for distribution of electrical energy from the supplier meter board to the numerous electrical energy consuming devices such as lamps, fans and other domestic appliances through controlling and safety devices is known as a wiring system. A typical house wiring circuit is shown in Fig-1

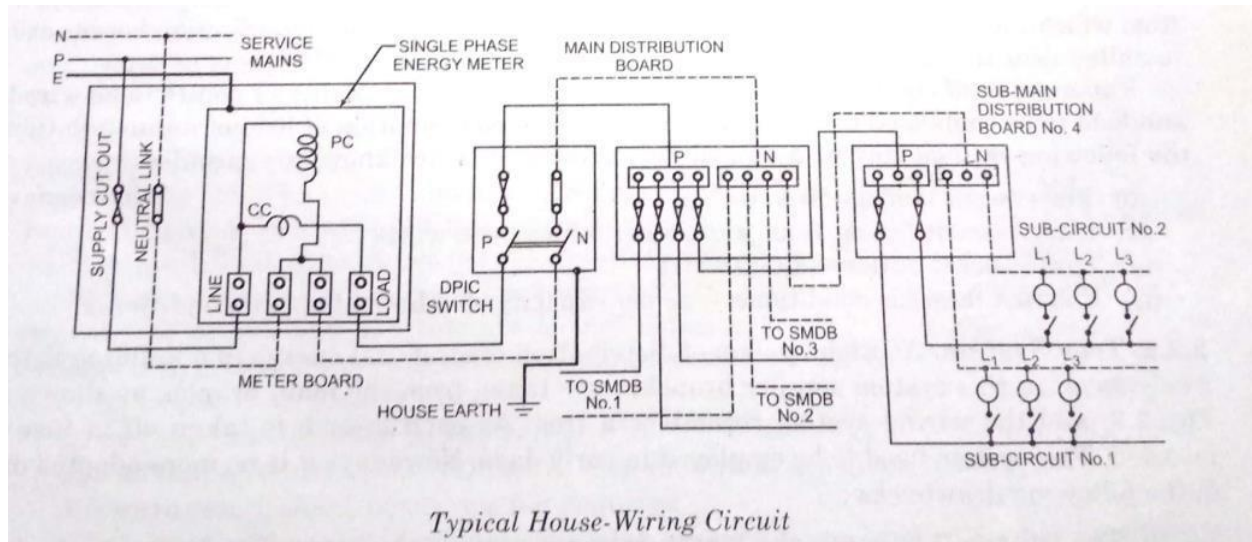

**Fig-1**

**Systems of distribution of electrical energy:** Since as per recommendation of Indian Standards the maximum number of points of lights, fans and 5A socket outlet that can be connected in one circuit is 10 and the maximum load that can be connected in such a circuit is 800 W, in case more load or points are required to be connected to the supply, then it is to be done by having more than one circuit.

**Distribution Board System:** In distribution board system, which is most commonly adopted for distribution of electrical in a building, the fuses of various circuits are grouped together on a distribution board, sometimes simply known as fuse board. Connections necessary for connecting two or more than two circuits, each consisting of 10 or less number of lamps is shown in fig.-2.

The two copper strips known as bus bars fixed in a distribution board of hardwood or metal case are connected to the supply mains through a double pole iron clad (DPIC) switch so that the installation can be switched off. A fuse is inserted in the positive or phase pole of each circuit so that each circuit is connected up through its own particular fuse.

The number of circuits and sub-circuits is decided as per number of points to be wired and load to be connected to the supply system.

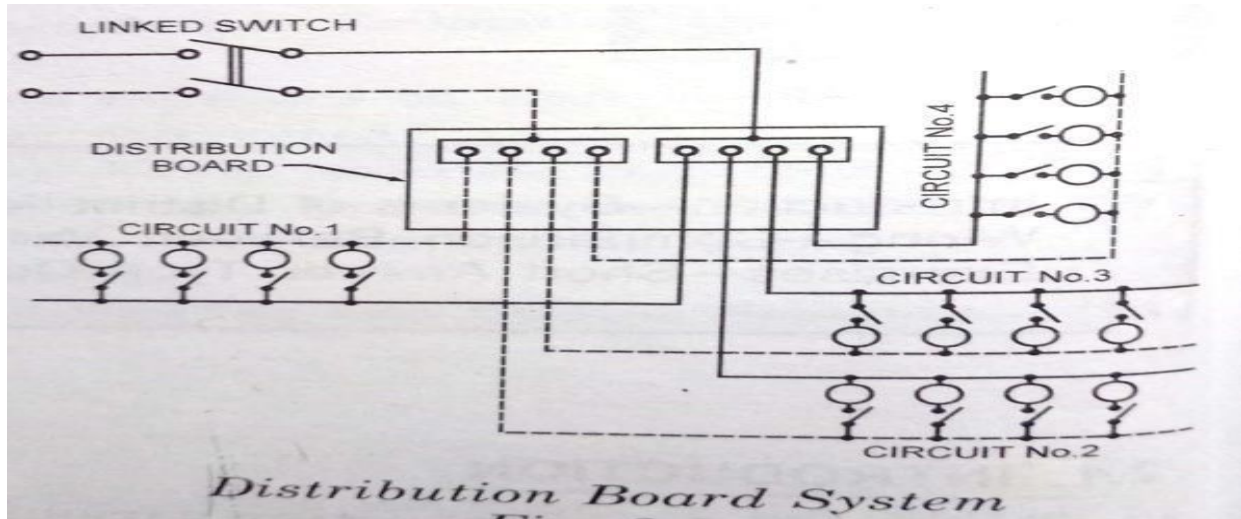

Fig-2

**Tree system:** Another system of distribution of electrical energy in a building is a tree system. In this system smaller branches are taken from the main branch as shown in fig.-3 and the wiring system resembles a tree. As each branch is taken off, a fuse is inserted. This system used to be employed in early days. Now a days it is no more adopted due to the following drawbacks.

- (i) The voltage across all the lamps does not remain the same.
- (ii) A number of joints are involved in every circuit.
- (iii) Fuses are scattered.
- (iv) In case of occurrence of faults all the joints have to be located.

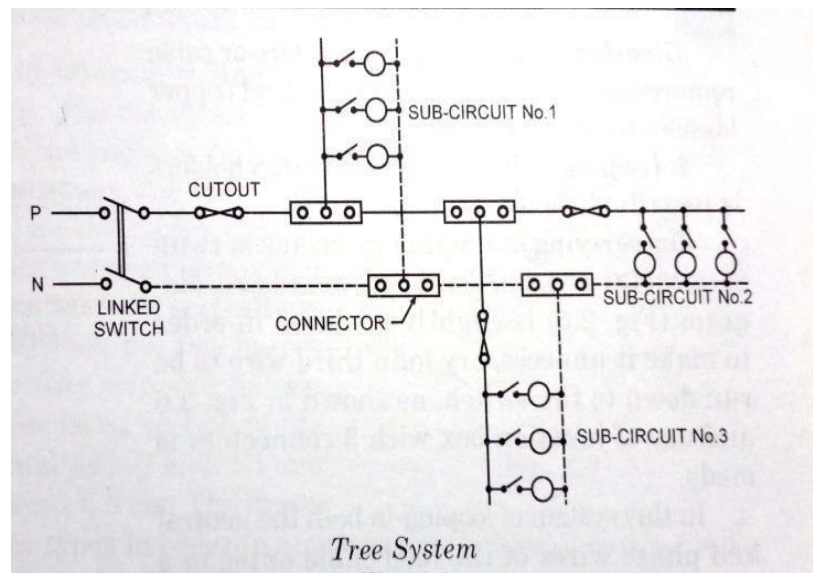



Fig-3

**Methods of Wiring:**

There are two **methods** of wiring known as joint box system (or Tee system) and loop in system.

**(i) Joint Box or Tee System:** In joint box system the connections to the lamps are made through joints made in joint box by means of suitable connectors or joint cutouts. In this method though there is a saving in the quantity of wire or cable required but the same is offset by the extra cost of joint boxes. The other disadvantage is the number of 'T' connection made in wiring system results in weakness if not properly made. Now a days the use of this system is limited to temporary installations only as its cost is low.

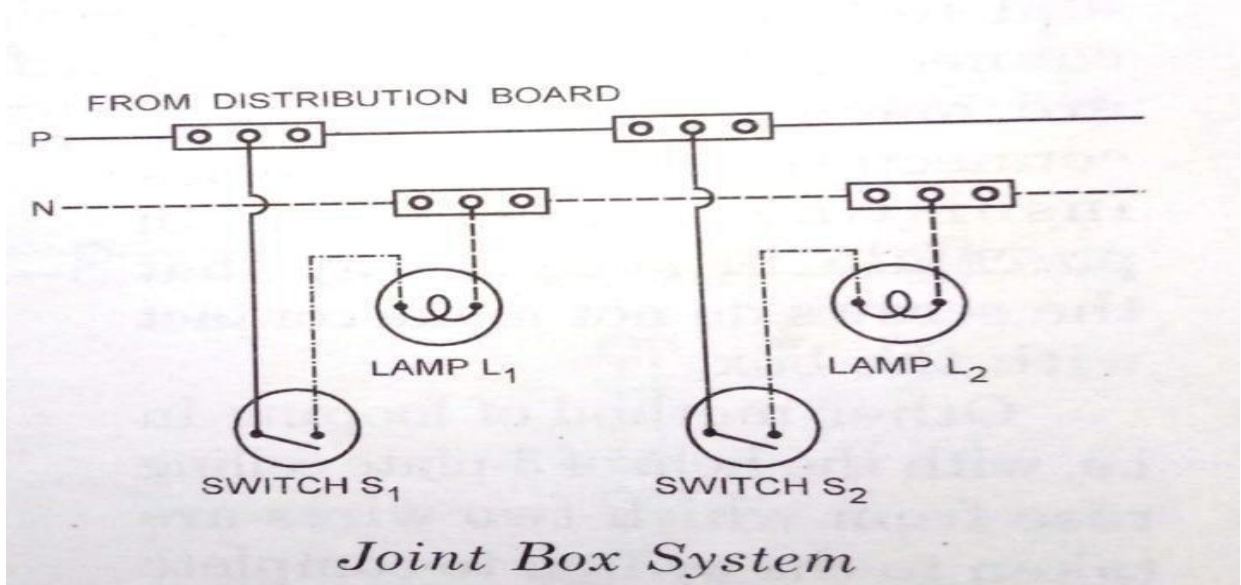
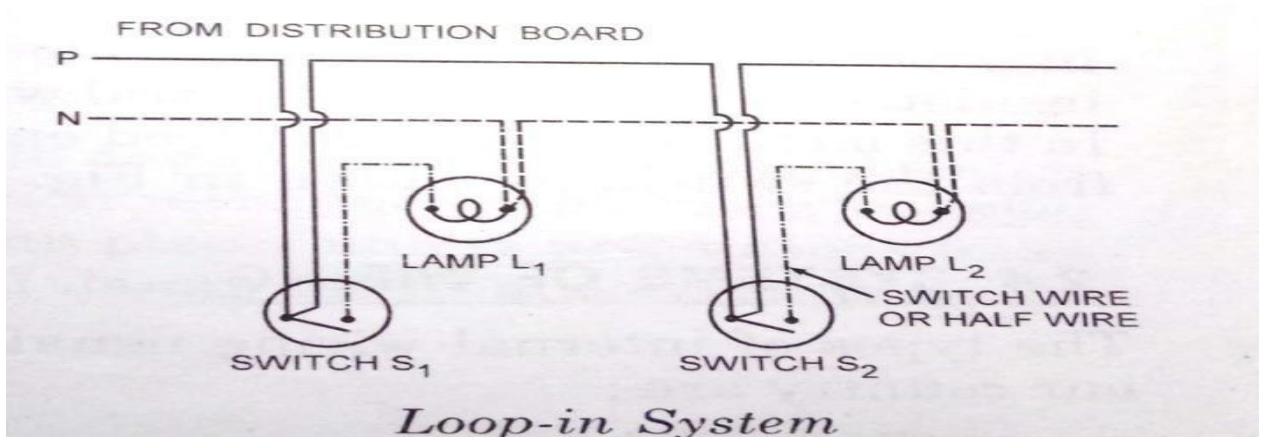

Fig-4

**(ii) Loop-in System:**

this system is universally used for connections of various lamps or other appliances in parallel. In this system when a connection is required at a light or switch, the feed conductor is looped in by bringing it direct to the terminal and then carrying it forward again to the next point to be fed as shown in fig.- 4. The switch and light feeds are carried round the circuit in a series of loops from one point to another until the last point on the circuit is reached.



The phase or line conductors are looped either in switch board or box and neutrals are looped either in switch board or from light or fan. Line or phase should never be looped from light or fan.

**Selection or choice of wiring system:**

- (i) Safety
- (ii) Durability

- (iii) Appearance
- (iv) Mechanical protection
- (v) Accessibility
- (vi) Low initial cost
- (vii) Low maintenance cost

**Types of Electrical wiring systems:**

- (1) Cleat wiring system
- (2) TRS wiring system
- (3) Lead sheathed wiring system
- (4) Wooden batten wiring system
- (5) Plastic Casing-capping system
- (6) Conduit wiring system
  - (i) Conduit surface wiring
  - (ii) Concealed conduit wiring

**1. Cleat wiring system:** In this system of internal wiring the cables used are either vulcanized Indian Rubber (VIR) or Polyvinyl chloride (PVC) type. The cables are held by porcelain cleats about 6 mm above the walls or ceiling. The cleats are made in two halves, one base and the other cap. The base is grooved to accommodate the cables and the cap is put over it and the whole of it is then screwed on the wooden plugs (gutties) previously cemented into the wall and ceiling. The cleats used are of different sizes and different types in order to accommodate cables of various sizes and different number of cables respectively. The cleats are of three types; one groove, two grooves and three grooves to accommodate one, two and three cables respectively.

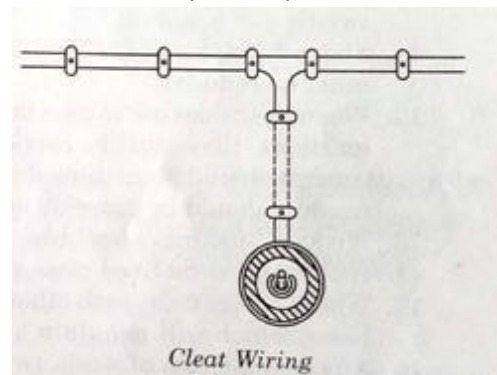
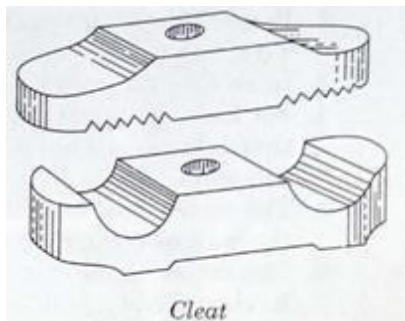

**Advantages:**

- (i) It is the cheapest system of internal wiring.
- (ii) Its installation and dismantlement is easy and quick.
- (iii) Material is recoverable after the dismantlement.
- (iv) Inspection, alterations and additions can be easily made.
- (v) Skilled labour required is little.

**Disadvantages:**

- (i) It is not good looking.
- (ii) The wires are exposed to mechanical injury.
- (iii) Oil and smoke are injurious to VIR insulation.

**2. Casing-Capping wiring system:** This is one of the simplest form of electrical wiring system. This is little bit old/conventional wiring system. Now a days, we often use this wiring system. PVC insulated cables are placed in plastic casing and covered with cap. The casing is of rectangular cross section.

The colour of casing channel and cap are normally white or grey. The casing channel and cap are normally made of plastic. The casing channels and caps are available in market in standard sizes.

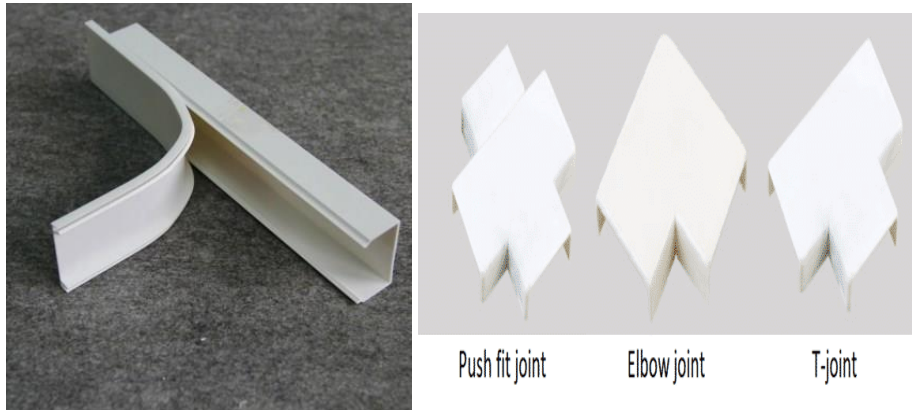

**Advantages:**

- (i) It is the cheapest wiring system as compared to concealed wiring system.
- (ii) It is strong and long lasting wiring system.
- (iii) Replacement and alteration of defective wire is easy.
- (iv) It provides protection against mechanical damage.
- (v) It is safe from oil, steam, smoke and rain.
- (vi) No risk of electric shock due to covered wires and cables in casing and capping.

**Disadvantages:**

- (i) Since it requires better workmanship, the labour cost is high.
- (ii) This type of wiring can be used only on surface and cannot be concealed in plaster.
- (iii) Internal condensation of moisture may cause damage to the insulation.

**3. Lead Sheathed or Metal-Sheathed Wiring:**

This type of wiring allows the conductor. Which is insulated with VIR. It has about 95% lead aluminum alloy in the outer casing which protects the metal casing from moisture, mechanical damage, and atmospheric corrosion. The entire lead covering is electrically seamless and is attached to the ground at the point of entry to protect against electrolytic action due to leakage and to provide safety if the casing comes alive. The cable is run on a wooden bat and fixed by link clips just like the TRS wiring.

**4. Batten Wiring (CTS or TRS):**

This type of wiring uses single-core, double core, or round oval cable with three core TRS cable. For this, a single-core cable is preferred. TRS cable is waterproof, chemical proof, steam proof but can be affected by lubricating oil. The TRS cable is fixed to the strong teak wood with a thickness of at least 10 mm.

The cable is placed on the wooden buttons via a tinned brass link clip (buckle clip), which is already fixed to the baton with brass pins and is 10 cm for horizontal runs and 15 cm for vertical runs. Occurs at intervals.

# Batten Wiring



## ***Advantages of Batten Wiring:***

**The Benefits of Batten Wiring are as follows:**

- This is easy to maintain.
- Modifications to this wiring can be made easily.
- The life of this wiring is long.
- Looks good in appearance.
- Costs are lower compared to another wiring.
- The probability of current leakage remains low.

## ***Disadvantages of Batten Wiring:***

**The disadvantages of Batten Wiring are as follows:**

- There is a risk of fire.
- Due to moisture, chemical effect, it is not suitable for outdoor use.
- Only suitable for use below 250V.
- Heavy wire is not used in this wiring.
- More cables and wires are needed.

**Conduit wiring system:** In this system of wiring steel tubes or PVC pipes known as conduits are installed on the surface of wall by means of saddles or buried under plaster and VIR or PVC cables are drawn afterwards by means of GI wire.

## **Surface Conduit Wiring**

If conduits installed on roof or wall, It is known as surface conduit wiring. in this wiring method, they make holes on the surface of wall on equal distances and conduit is installed then with the help of rawal plugs.

## **Concealed Conduit wiring**

If the conduits is hidden inside the wall slots with the help of plastering, it is called concealed conduit wiring. In other words, the electrical wiring system inside wall, roof or floor with the help of plastic or metallic piping is called concealed conduit wiring. obviously, It is the **most popular, beautiful, stronger and common electrical wiring system** nowadays.



**Advantages:**

- (i) It provides protection against mechanical damage.
- (ii) It provides complete protection fire due to short circuit.
- (iii) The whole system is waterproof.
- (iv) Replacement and alteration of defective wiring is easy.
- (v) Its life is long.
- (vi)** It is shocked proof also if earthing is properly done.

**Disadvantages:**

- (i) It is very costly system of wiring.
- (ii)** Its erection is not easy and required time.
- (iii) Experienced and highly skilled labour is required for carrying out the job.

**Comparison between Different Wiring Systems**

Below is the table which shows the comparison between all the above mentioned wiring systems.

Sl no	Particulars	Cleat Wiring	Casing capping Wiring	Lead Sheath Wiring	CTS or TRS or Batten Wiring	Conduit wiring
1	<b>LIFE</b>	Short	Fair long	Long	Long	Very Long
2	<b>COST</b>	Low	Medium	High	Medium	Highest
3	<b>Mechanical Protection</b>	None	Fair	Fairly Long	None	Very Good
4	<b>Possibility of Fire</b>	Nil	Good	good	Good	Nil
5	<b>Protection From Dampness</b>	None	A little	None	None	good
6	<b>Types of labor required</b>	Semi skilled	Highly skilled	Semi skilled	Semi skilled	High Skilled
7	<b>Installation</b>	Very Easy	Difficult	Easy	Easy	Difficult
8	<b>Inspection</b>	Easy	easy	Easy	Easy	Difficult
9	<b>Repair</b>	Easy	A little difficult	Difficult	Easy	Difficult
10	<b>Popularity</b>	Nil	Fair	Nil	Nil	Very High

**Conductor materials used in cables:** The function of conductor usually known as core in cable is to carry electrical current. Copper and aluminium are the materials used as conductors in power and lighting cables.

**Copper:** Though silver is the best conductor of heat and electricity but due to its high cost it is rarely used. The next best conductor is copper. It is cheaper as compared to silver. The electrical conductivity of copper is comparatively high. The resistivity of pure copper is  $1.786 \times 10^{-8} \Omega\text{-m}$ . It is mechanically strong, hard, extremely tough, durable and ductile. It is highly resistive to corrosion, oxidation etc. it can be easily soldered and welded. The specific weight of copper is  $8900 \text{ kg/m}^3$  at  $20^\circ\text{C}$  or  $9.9 \text{ g/cm}^3$ . Its melting point is  $1083^\circ\text{C}$ .

**Aluminium:** Aluminium is frequently used in place of copper for electric cables used for long distance power distribution. The electrical conductivity of aluminium is about 60% of copper (resistivity being  $2.87 \times 10^{-8} \Omega\text{-m}$  at  $20^\circ\text{C}$ ) so for same resistance for a given length, the aluminium required will be 1.61 times that of copper in volume and 1.26 times that of copper in diameter. The only application of aluminium cables for wiring in the buildings is for the 'continuous busbar' system of distribution.

**Classification of cables:** The cables employed for internal wiring of building may be divided into different groups.

According to:

- (i) Conductor used
  - (ii) Number of cores
  - (iii) Voltage grading
  - (iv) Types of insulation used.
- (i) According to conductor:
- (a) Copper conductor cable
  - (b) Aluminium conductor cable
- (ii) According to number of cores:
- (a) Single core cable
  - (b) Two core cable
  - (c) Three core cable
- (iii) According to voltage Grading:
- (a) 250/440 V cable
  - (b) 650/100 v cable
- (iv) According to type of insulation:
- (a) Vulcanized Indian rubber (VIR) cable
  - (b) Polyvinyl chloride (PVC) cable
  - (c) Lead sheathed cable
  - (d) Weather proof cable
  - (e) Flexible cable
  - (f) Cross linked polyethylene (XLPE) cable
  - (g) Tough rubber sheathed (TRS) cable

**Insulating Materials:** the conductor is covered with insulating material so that it may prevent leakage of current from the conductor i.e. the insulating material should be extremely high resistive to the flow of electric current through it. The insulating materials used in electric cables should possess the following properties:

- (i) High insulation resistance to avoid the leakage current.
- (ii) High dielectric strength to avoid electrical breakdown of the cable.
- (iii) High mechanical strength to withstand the mechanical handling of cables.
- (iv) Non-hygroscopic
- (v) Non-inflammable
- (vi) Low cost
- (vii)** Unaffected by acids and alkalies to avoid any chemical action.

### **Types of insulating Materials:**

**Rubber:** Rubber may be obtained from milky sap of tropical trees or it may be produced from oil products. It has relative permittivity varying between 2 and 3, dielectric strength is about 30 kV/mm and resistivity of insulation is  $10^{17} \Omega\text{-cm}$ . Although pure rubber has reasonably high insulating properties, it suffers from some major drawbacks *viz.*, readily absorbs moisture, maximum safe temperature is low (about 38°C), soft and liable to damage due to rough handling and ages when exposed to light. Therefore, pure rubber cannot be used as an insulating material.

**Vulcanised India Rubber (V.I.R.).** It is prepared by mixing pure rubber with mineral matter such as zinc oxide, red lead etc., and 3 to 5% of sulphur. The compound so formed is rolled into thin sheets and cut into strips. The rubber compound is then applied to the conductor and is heated to a temperature of about 150°C. The whole process is called *vulcanisation* and the product obtained is known as vulcanised India rubber.

Vulcanised India rubber has greater mechanical strength, durability and wear resistant property than pure rubber. Its main drawback is that sulphur reacts very quickly with copper and for this reason, cables using *VIR* insulation have tinned copper conductor. The *VIR* insulation is generally used for low and moderate voltage cables.

**Impregnated paper.** It consists of chemically pulped paper made from wood chippings and impregnated with some compound such as paraffinic or naphthenic material. This type of insulation has almost superseded the rubber insulation. It is because it has the advantages of low cost, low capacitance, high dielectric strength and high insulation resistance. The only disadvantage is that paper is hygroscopic and even if it is impregnated with suitable compound, it absorbs moisture and thus lowers the insulation resistance of the cable. For this reason, paper insulated cables are always provided with some protective covering and are never left unsealed. If it is required to be left unused on the site during laying, its ends are temporarily covered with wax or tar.

Since the paper insulated cables have the tendency to absorb moisture, they are used where the cable route has a few joints. For instance, they can be profitably used for distribution at low voltages in congested areas where the joints are generally provided only at the terminal apparatus. However, for smaller installations, where the lengths are small and joints are required at a number of places, *VIR* cables will be cheaper and durable than paper insulated cables.

**Varnished cambric.** It is a cotton cloth impregnated and coated with varnish. This type of insulation is also known as empire tape. The cambric is lapped on to the conductor in the form of a tape and its surfaces are coated with petroleum jelly compound to allow for the sliding of one turn over another as the cable is bent. As the varnished cambric is hygroscopic, therefore, such cables are always provided with metallic sheath. Its dielectric strength is about 4 kV/mm and permittivity is 2.5 to 3.8.

**Polyvinyl chloride (PVC).** This insulating material is a synthetic compound. It is obtained from the polymerisation of acetylene and is in the form of white powder. For obtaining this material as a cable insulation, it is compounded with certain materials known as plasticizers which are liquids with high boiling point. The plasticizer forms a gell and renders the material plastic over the desired range of temperature.

Polyvinyl chloride has high insulation resistance, good dielectric strength and mechanical toughness over a wide range of temperatures. It is inert to oxygen and almost inert to many alkalis and acids. Therefore, this type of insulation is preferred over *VIR* in extreme environmental conditions such as in cement factory or chemical factory. As the mechanical properties (*i.e.*, elasticity etc.) of *PVC* are not so good as those of rubber, therefore, *PVC* insulated cables are generally used for low and medium domestic lights and power installations.

**(1) PVC cables:** These cables are available in 250/440 v and 650/1100 V and are used in casing-capping, wooden batten and conduit wiring system. In this type of cable conductor is insulated with *PVC* insulation. Since *PVC* is harder than rubber, *PVC* cables does not required cotton tapping and bedding over it for mechanical and moisture protection.

**(2) Weather Proof Cable:** These cables are used for outdoor wiring and for power supply or industrial supply. These cables are either PVC insulated or VIR insulated conductors. Being suitably tapped (only in case of VIR cable)

braided and then compounded with weather resisting material. These cables are available in 240/415 V and 650/1100 V. These cables are not affected by heat or sun or rain.

**(3) Flexible cords and cables:** the flexible cords consist wires silk/cotton/plastic covered. Plastic cover is popular as it is available in different colours. Flexible cords have tinned copper conductors. Flexibility and strength is obtained by using conductors having number of strands. These wires or cables are used as connecting wires for such purposes as from ceiling rose to lamp holder, socket outlet to portable apparatus such as radios, fans, lamps heaters etc. These must not be used in fixed wiring.

#### ACCESSORIES

##### Wiring Accessories

Wiring accessories are used for connecting appliances

###### a) Switch

A switch is used to make or break an electrical circuit. It is used to switch 'on' or 'off' the supply of electricity to an appliance. There are various switches such as

1. surface switch
2. flush switch
3. ceiling switch
4. pull switch y
5. push button switch
6. bed switch

(i) Surface switch: It is mounted on wooden boards fixed on the surface of a wall. It is of three types

1. One-way switch
2. Two-way switch
3. Intermediate switch

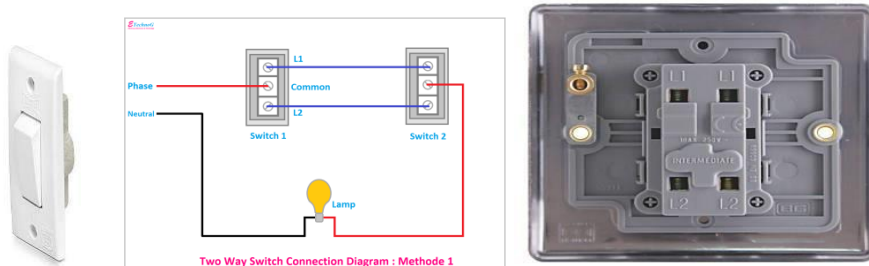

1. One-way switch: It is used to control single circuits and lamp

2. Two-way switch: It is used to divert the flow of current to either of two directions. The two-way switch can also be used to control one lamp from two different places as in the case of staircase wiring

3. Intermediate switch: It is used to control a lamp from more than two locations

(i) Flush switch: It used for decorative purpose



(iii) Bed switch: As the name indicates, it is used to switch 'on' the light from any place, other than switch board or from near the bed. This switch is connected through a flexible wire



(a) Holders

A holder is of two types.

1. Pendant holder
2. Batten holder



- C. Ceiling rose It is used to provide a tapping to the pendant lamp– holder through the flexible wire or a connection to a fluorescent tube



- (d) Socket outlet/plug The socket outlet has an insulated base with the moulded or socket base having three terminal sleeves

(e) Main switch

To control the electrical circuit a main switch is used. Through the main switch, the power in a building is controlled completely.

Miniature Circuit Breaker (MCB)

A MCB is used in new constructions instead of the older types of fuses. Circuit breakers are small devices used to control and protect the electrical panel and the other devices from overflowing of electrical power



**Difference between MCB and MCCB**

S.No	MCB	MCCB
1	It stands for Miniature Circuit Breaker.	It stands for Molded Case Circuit Breaker.
2	Rated current not more than 125 Ampere.	Rated Current up to 1600A

3	Its interrupting current rating is under 10KA	Their interrupting current ranges from around 10KA -85KA
4	Judging from their power capacities, MCB is mainly used for low Breaking capacity requirement mainly domestic.	MCCB is mainly used for both low and high Breaking capacity requirements mainly industrial.
5	Its trip characteristics are normally not adjustable since they basically cater to low circuits.	Its trip current may be fixed as well as adjustable for overload and magnetic setting.

### Difference between RCCB and ELCB

S.No	RCCB	ELCB
1.	RCCB refers to ear stands for Residual Current Circuit Breaker.	ELCB stands for Electric Leakage Circuit Breaker.
2.	It is a new name and refers to current operated devices.	ELCB refers to voltage operated earth leakage device.
3	It ensures 100% detection of leakage current& is available to sense the AC as well as DC leakage current.	It is not preferable as it can only detect current that flow back through the main earth wire.
4	RCCB has no connection with the earth wire and that's why it can trip when both currents (phase and neutral) are different and it withstands up to both the currents are same.	ELCB is working based on Earth leakage current. These devices measured the voltage on the earth conductor; if this voltage was not zero this indicated a current leakage to earth.

**Fuse:** Fuse is a current interrupting device which breaks or opens the circuit (in which it is inserted) by fusing the element when the current in the circuit exceeds a certain value.

**Fuse Element or Fuse wire:** It is that part of the fuse which actually melts when an excessive current flows in the circuit and thus isolates the faulty device from the supply circuit.

**Principle of Operation:** The action of a fuse is based upon the heating effect of the electric current. In normal operating conditions, when the current flowing through the circuit is within safe limits, the heat developed in the fuse element carrying this current is readily dissipated into the surrounding air, therefore, fuse element remains at a temperature below its melting point. However, when some fault such as short circuit occurs or when the

load connected in a circuit exceeds its capacity, the current exceeds the limiting value, the heat generated due to this excessive current cannot be dissipated fast enough and the fusible element gets heated, melts and breaks the circuit.

**Current Rating:** This rating is specified by manufacturer. It is defined as the rms value of the current which the fuse wire can carry continuously without deterioration, and with temperature rise within specified limit.

**Fusing Current:** It is defined as the minimum value of current at which the fuse element or fuse wire melts.

For a round wire the approximate value of fusing current is given by  $I = k d^{3/2}$

where  $k$  is constant called the fuse constant, depending upon the metal of the fuse element. Sir W.H. Preece has given the value of the constant  $k$  as indicated in the table.

S.No.	Metal	Melting point in oC	Specific resistance in $\mu\Omega\text{-mm}$	Value of fuse constant $k$ for $d$ in $m$
1	Silver	980	16	-
2	Tin	240	112	12.8
3	Zinc	419	60	-
4	Lead	328	210	10.8
5	Copper	1090	17	80
6	Aluminium	665	28	59

**Fuse Element Materials:** The materials used fuse element must be of low melting point, low ohmic losses, high conductivity (or low resistivity), low cost and free from deterioration. Experience has shown that the most generally suitable material for the fuse element is a low melting point material such as tin, lead or zinc.

The materials commonly used for fuse elements are tin, lead, silver, copper, zinc, aluminium and alloy of lead and tin. An alloy of lead and tin (lead 37% and tin 63%) is used for small current rating fuses (say not beyond 15A). For current exceeding 15 A this alloy is not used as the diameter of the wire will be larger and after fusing the metal released will be excessive.

#### **Advantages of Fuse:**

- It is the cheapest form of protection available.
- It needs no maintenance.
- Its operation is completely automatic.
- It interrupts an enormous short circuit current without noise, flame, gas or smoke.

#### **Disadvantages:**

Considerable time is lost in rewiring or replacing a fuse element after operation.

#### **Earthing**

Earthing is defined as "the process in which the instantaneous discharge of the electrical energy takes place by transferring charges directly to the earth through low resistance wire."

Low resistance earthing wire is chosen to provide the least resistance path for leakage of fault current.

The metal link is normally of MS flat, CI flat, GI wire which should be penetrated to the ground earth grid.

#### **IS specification for Earthing**

For providing good earthing the following are recommended specifications as per ISI

- The earthing electrode should be situated at a place at least 1.5 meters away from the building (outside) whose installation system is being earthed.
- The earth wire should be of same material as that of earth electrode used.
- The minimum sectional area of earth lead wire should not be less than 0.02 sq. inch and not more than 0.1 sq. inch.

4. As a general rule, the size of earth conductor should not be less than half of the section of the line conductor.
5. The earth wire should be taken through G.I pipe of 1mm diameter for at least 32cm length above and below ground surface to the earth electrode to safeguard against mechanical wear and tear.
6. For effective earthing, loose earth and coal salt mixture should be filled around the earth electrode .
7. All the joints in the earth wire should be firmly done with nuts and bolts of the same material as of earth wire.

### **Points to be Earthed**

Earthing is not done anyhow. According to IE rules and IEE (Institute of Electrical Engineers) regulations,

- Earth pin of 3-pin lighting plug sockets and 4-pin power plug should be efficiently and permanently earthed.
- All metal casing or metallic coverings containing or protecting any electric supply line or apparatus such as GI pipes and conduits enclosing VIR or PVC cables, iron clad switches, iron clad distribution fuse boards etc should be earthed (connected to earth).
- The frame of every generator, stationary motors and metallic parts of all transformers used for controlling energy should be earthed by two separate and yet distinct connections with the earth.
- In a dc 3-wire system, the middle conductors should be earthed at the generating station.
- Stay wires that are for overhead lines should be connected to earth by connecting at least one strand to the earth wires.

### **Determination of size of earth wire and plate for domestic and industrial installation**

he size or area of earthing lead should not be less than the half of the thickest wire used in the installation.

The largest size for earthing lead is **3SWG** and the minimum size should not be less than **8SWG**.

#### **Size of Earthing Electrode**

Both copper and iron can be used as earthing electrode.

#### **The size of earth electrode (In case of copper)**

2'x2' (two foot wide as well as in length) and 1/8 inch thickness.. I.e. **2' x 2' x 1/8"**. (**600x600x300 mm**)

#### **In case of Iron**

**2' x 2' x 1/4" = 600x600x6 mm**

It is recommended to bury the earth electrode in the moisture earth. If it is not possible, then put water in the GI (Galvanized Iron) pipe to make possible the moisture condition.

Earth Plate or Earth Electrode Size for Small installation

In small installation, use metallic rod (diameter = 25mm (1inch) and length = 2m (6ft) instead of earth plate for earthing system. The metallic pipe should be 2 meter below from the surface of ground. To maintain the moister condition, put 25mm (1inch) coal and lime mixture around the earth plate.

For effectiveness and convenience, you may use the copper rods 12.5mm (0.5 inch) to 25mm (1 inch) diameter and 4m (12ft) length. We will discuss the installation method of rod earthing latter.

### **Methods and Types of Electrical Earthing**

Earthing can be done in many ways. The various methods employed in earthing (in house wiring or factory and other connected electrical equipment and machines) are discussed as follows.

#### ***Plate Earthing:***

In plate earthing system, a plate made up of either copper with dimensions **60cm x 60cm x 3.18mm** (i.e. **2ft x 2ft x 1/8 in**) or galvanized iron (GI) of dimensions 60cm x 60cm x 6.35 mm (2ft x 2ft x 1/4 in) is buried vertical in the earth (earth pit) which should not be less than 3m (10ft) from the ground level.

For proper earthing system, follow the above mentioned steps in the (Earth Plate introduction) to maintain the moisture condition around the earth electrode or earth plate.

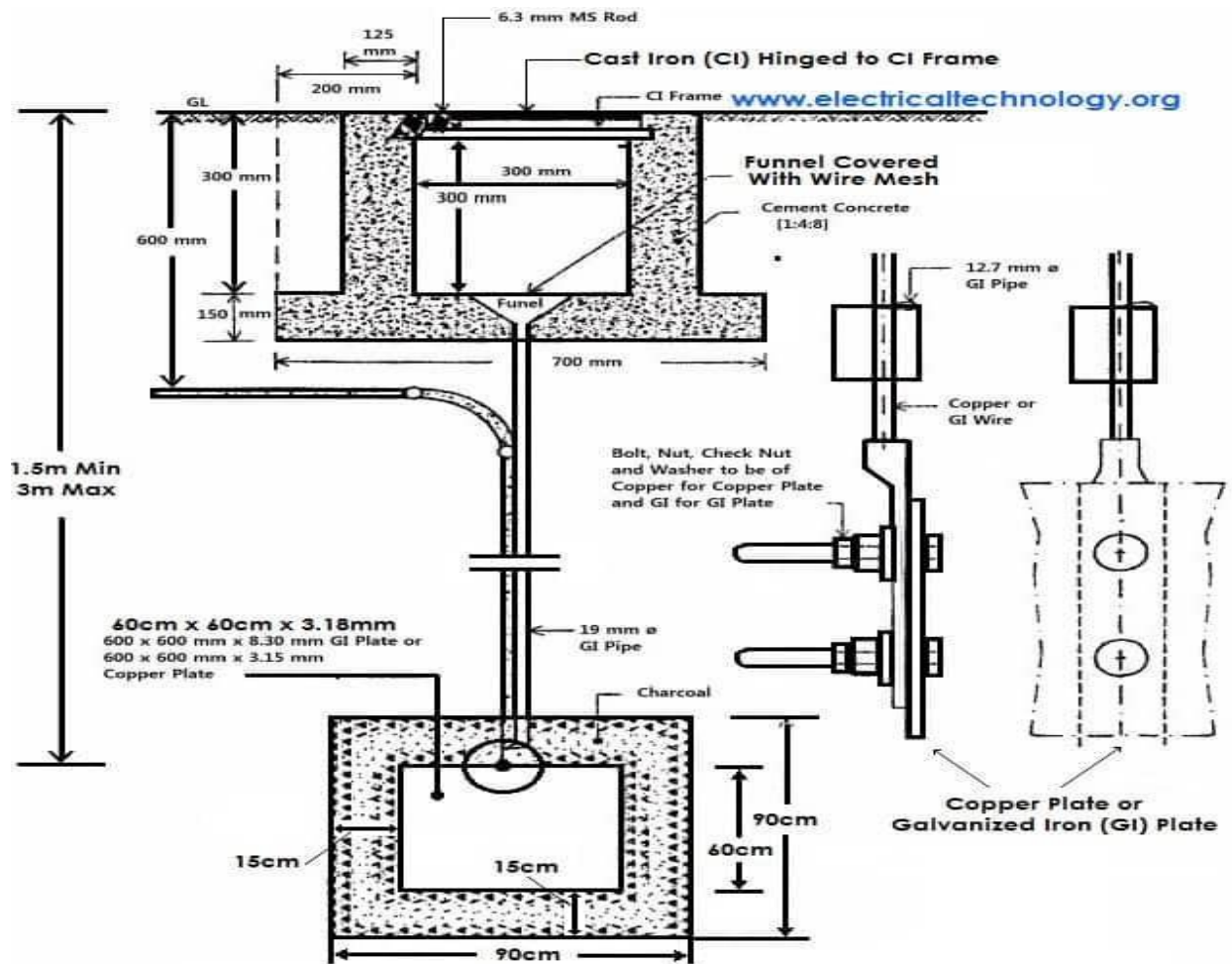

# Plate Earthing

## Pipe Earthing:

A galvanized steel and a perforated pipe of approved length and diameter is placed vertically in a wet soil in this kind of system of earthing. It is the most common system of earthing.

The size of pipe to use depends on the magnitude of current and the type of soil. The dimension of the pipe is usually 40mm (1.5in) in diameter and 2.75m (9ft) in length for ordinary soil or greater for dry and rocky soil. The moisture of the soil will determine the length of the pipe to be buried but usually it should be 4.75m (15.5ft).

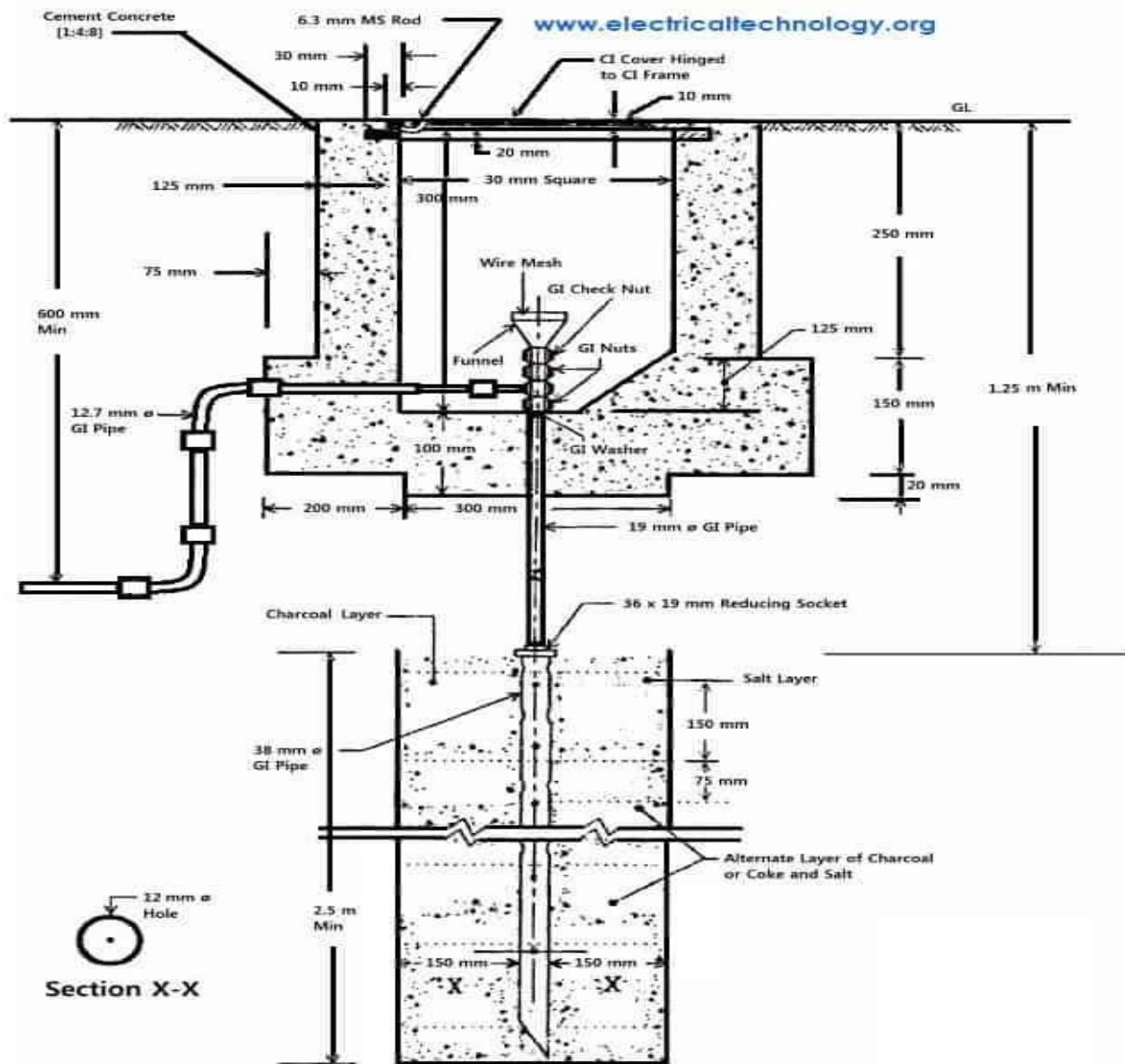

# Pipe Earthing

## General Method of Electrical Earthing Installation (Step by Step)

The usual method of earthing of electric equipments, devices and appliances are as follow:

1. First of all, dig a 5x5ft (1.5x1.5m) pit about 20-30ft (6-9 meters) in the ground. (Note that, depth and width depends on the nature and structure of the ground)
2. Bury an appropriate (usually 2' x 2' x 1/8" (600x600x300 mm) copper plate in that pit in vertical position.
3. Tight earth lead through nut bolts from two different places on earth plate.
4. Use two earth leads with each earth plate (in case of two earth plates) and tight them.
5. To protect the joints from corrosion, put grease around it.
6. Collect all the wires in a metallic pipe from the earth electrode(s). Make sure the pipe is 1ft (30cm) above the surface of the ground.
7. To maintain the moisture condition around the earth plate, put a 1ft (30cm) layer of powdered charcoal (powdered wood coal) and lime mixture around the earth plate of around the earth plate.

8. Use thimble and nut bolts to connect tightly wires to the bed plates of machines. Each machine should be earthed from two different places. The minimum distance between two earth electrodes should be 10 ft (3m).
9. Earth continuity conductor which is connected to the body and metallic parts of all installation should be tightly connected to earth lead. Make sure to use the continuity by using continuity test.
10. At last (but not least), test the overall earthing system through earth tester. If everything is going about the planning, then fill the pit with soil. The maximum allowable resistance for earthing is 1Ω. If it is more than 1 ohm, then increase the size (not length) of earth lead and earth continuity conductors. Keep the external ends of the pipes open and put the water time to time to maintain the moisture condition around the earth electrode which is important for the better earthing system.

#### MATERIAL REQUIRED FOR GI PIPE EARTHING

S.NO.	Description of Material With Complete Specification	Quantity Required	
		Quantity	Unit
1.	25mm diameter GI Pipe	2.5	Meters
2.	19mm diameter GI pipe for watering	1.5	-do-
3.	13 mm diameter GI pipe	4.0	-do-
4.	GI Wire 6 SWG	12.0 (1.2)	m(kg)
5.	GI lugs	2	nos.
6.	10 mm diameter 32 mm long G.I bolts and nuts	2	nos.
7.	16mm diameter 40 mm long GI bolts and washers	2	nos.
8.	13 mm diameter GI bends	1	no.
9.	30 cm square cast iron frame	1	no.
10.	30 cm square cast iron cover	1	no.
11.	Funnel with mesh	1	no.
12.	Charcoal	10	Kg
13.	Common salt	10	Kg
14.	Cement concrete 1:4:8	0.15	m <sup>3</sup>

#### LIGHTING SCHEME

##### ASPECTS OF GOOD LIGHTING SYSTEM

The lighting scheme should be such that it may:

- (i) Provide adequate illumination,
- (ii) Provide light distribution all over the working plane as uniform as possible,
- (iii) Provide light of suitable colour, and
- (iv) Avoid glare and hard shadows as far as possible.

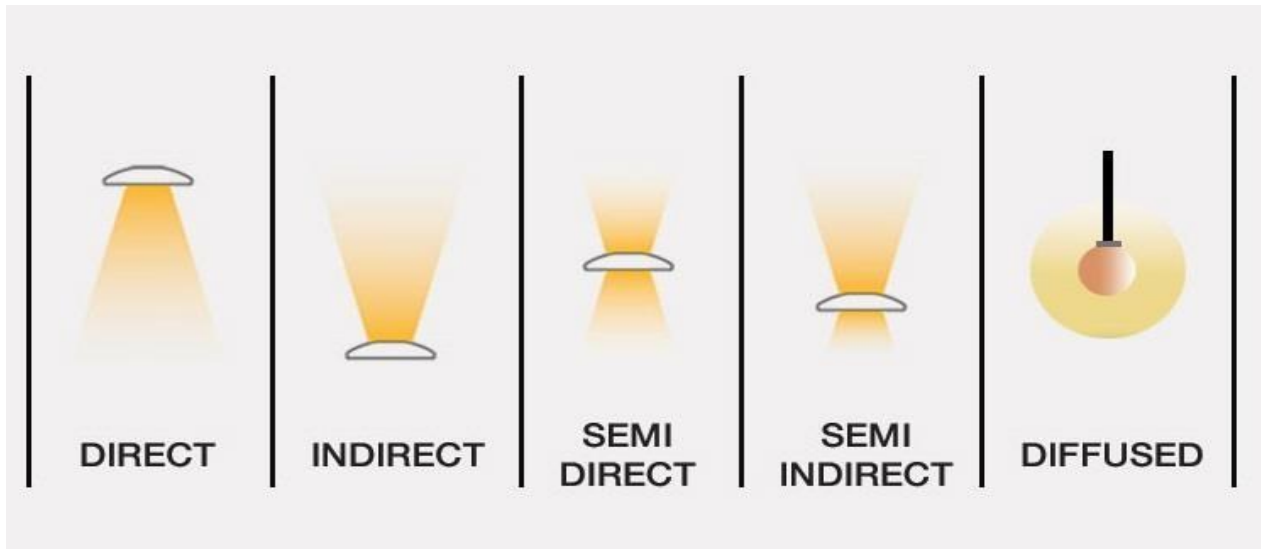

#### DIFFERENT TYPES OF LIGHTING SCHEME

(i) direct lighting, (ii) indirect lighting, (iii) semi-direct lighting, (iv) semi-indirect lighting, and (v) general diffusing systems.

#### (a) Direct Lighting Schemes :

- By this method most of the light source is made available on the working surface and very few percent is wasted.
- The light energy is lighting sources, are hung and light is diverted by proper shaped reflectors or globes. so number of light units needed are less and overall cost of the illumination scheme is reduced.
- Though this system is most efficient, the drawback of the system is that dark shadows fall on the working plate moreover there is a glare on the eyes.

HL - Lower hemisphere

UL - Upper hemisphere



(a) Dispersive type reflector

(b) Diffusing fitting

(c)

Concentrated reflector



### (b) Semi-Direct Lighting Schemes :

- In this scheme, about 60 to 90% of total light flux is made to fall on the working surface and 10 to 40% is allowed to fall on the ceiling and walls.

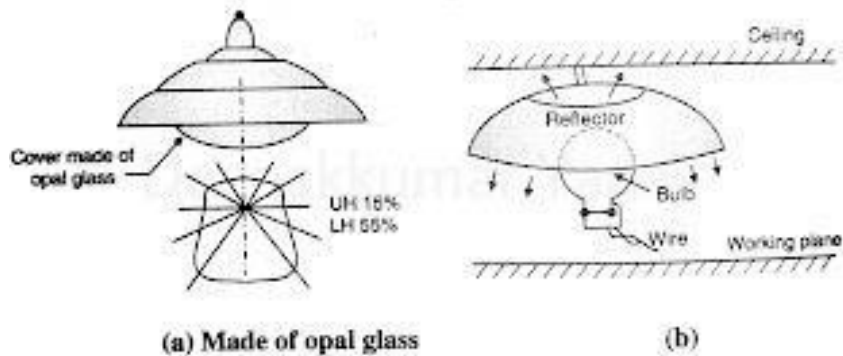

- This is achieved by providing semi-direct reflectors. Such a scheme is best suited to rooms having bigger heights. Glare is avoided and diffused bulbs are used.

### (c) Semi-Indirect Lighting Schemes :

- In this system, 60 to 90 % of the total light flux is diverted to fall on the ceilings from where the light is directed on the working surface by diffused reflection. Only 30 to 40 % flux reaches the working plane. Some is absorbed by the bowls.

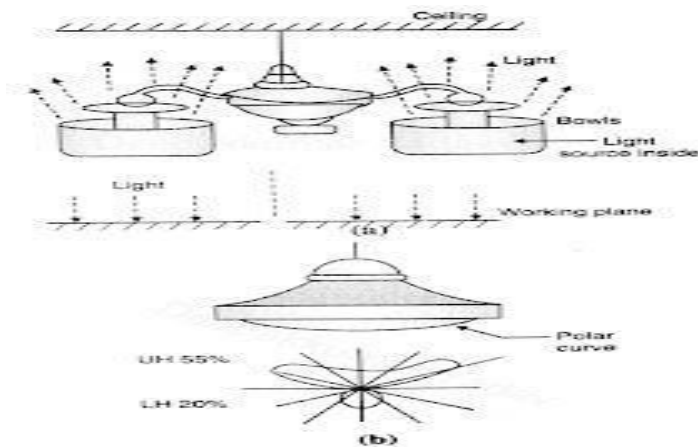

- This provides pleasant lighting, free from glare and shadows are very soft. Scheme is costly. But it is used for indoor decoration purposes. Bowls are semi-translucent type.

### d) Indirect Lighting Schemes :

- The light does not reach the working surface directly. The maximum light (about 90 %) is thrown towards the ceilings for diffused reflection by using inverted reflectors or bowl reflectors.
- As if the ceiling acts as a light source therefore the glare is reduced to the minimum value. Illumination is pleasant, defused and very soft and shadows are illuminated.
- Scheme is decorative. This scheme is suggested for function halls, cinema theatres, three star hotels. Also suggested for big workshops in the industries to avoid accidents due to shadows.

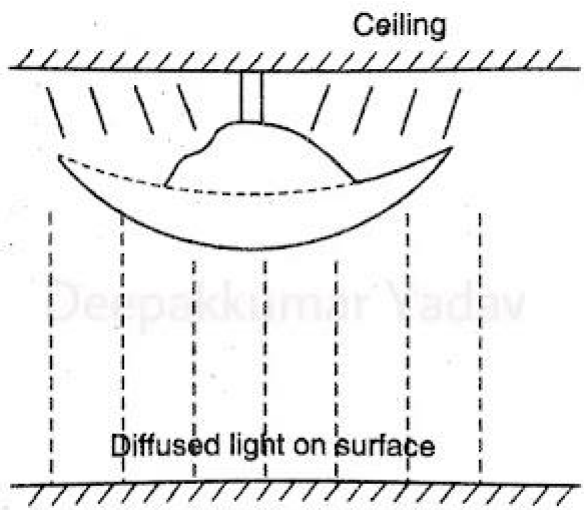

(a)

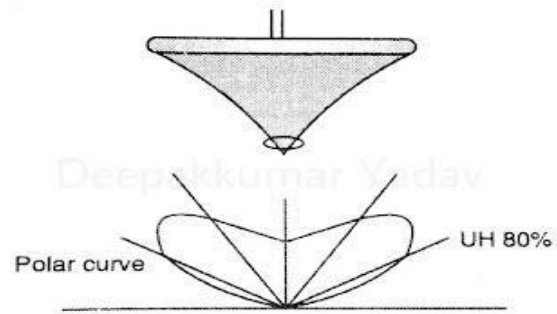

(b)

## STREET LIGHTING SYSTEM

**Street lighting design** is the design of street lighting such that people can safely continue their travels on the road. Street lighting schemes never brings the same appearance of daylight, but provide sufficient light for people to see important objects required for traversing the road. Street lighting plays an important role in:

- Reducing the risk of night-time accidents
- Assisting in the protection of buildings/property (discouraging vandalism)
- Discouraging crime
- Creating a secure environment for habitation

### Main Objectives of Street Lighting Design Scheme

The main objectives of street lighting design scheme are given below:

1. Perfect visual sensation for safety
2. Illuminated environment for quick movement of the vehicles
3. Clear view of objects for comfortable movement of the road users.

### Which Lamps are Used in Street Lighting?

Various types of lamps are used in street lighting luminaires. They are

1. High pressure sodium lamp
2. Metal Halide Lamps
3. Low pressure sodium lamps
4. Incandescent Lamp (not recommended)
5. LED
6. CFL (used in Lanes or streets only not widely)

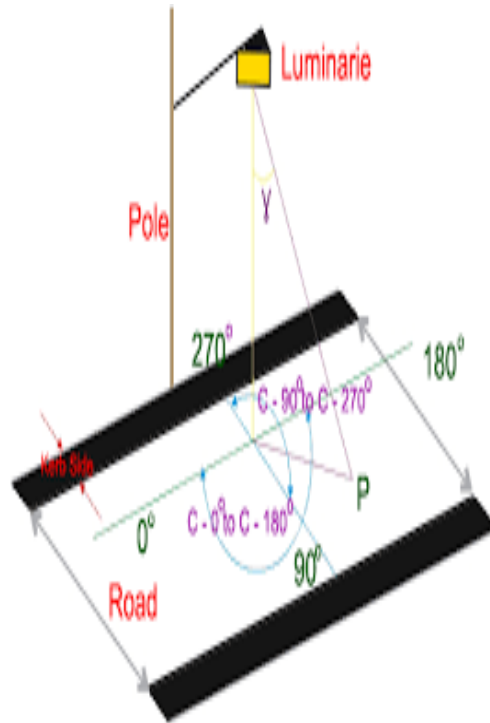
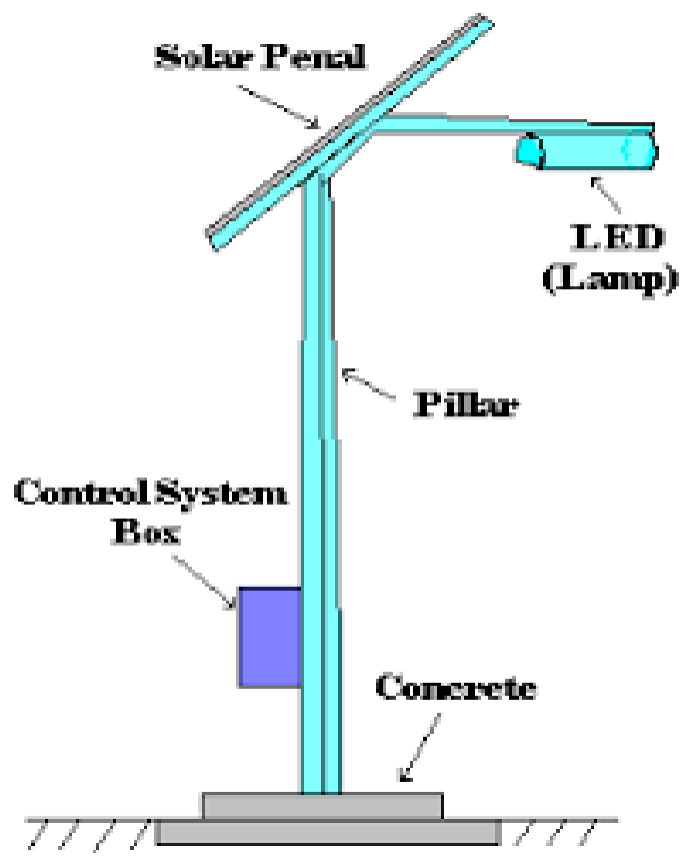

### General Rules For Wiring

The general rules, which are to be kept in mind in execution of internal wiring work, are:

1. Every installation is to be properly protected near the point of entry of supply cables by a two-pole linked main switch and a fuse unit. In a two-wire installation if one pole is permanently earthed, no fuse, switch or circuit breaker is to be inserted this pole. A 3-pole switch and fuse unit is to be used in 3-phase supply.
2. The conductor used is to be of such a size that it may carry load current safely.
3. The conductors installed are to be safe in all respects.
4. Every sub-circuit is to be connected to a distribution fuse board.
5. Every line (phase or positive) is to be protected by a fuse of suitable rating as per requirements.
6. A switch board is to be installed so that its bottom lies 1.25 to 1.5 metres above the floor.
7. (a) All plugs and socket-outlets are to be of 3-pin type, the appropriate pin of socket being connected permanently to the earthing system.  
 (b) Adequate number of socket-outlets is to be provided at suitable places in all rooms so as to avoid use of long lengths of flexible cords.  
 (c) Only 3-pin, 5 A socket-outlets are to be used in all light and fan sub-circuits and only 3-pin, 15 A socket-outlets are to be used in all power sub-circuits. All socket outlets are to be controlled by individual switches, which are to be located immediately adjacent to it. For 5 A socket-outlets, if installed at a height of 25 cm above the floor level, the switch may, if desired, be installed at a height 1.30 metres above the floor level. In situations where a socket-outlet is accessible to children, it is recommended to use shuttered or interlocked socket outlets.  
 (d) In case an appliance requiring the use of a socket outlet of rating higher than 15 A is to be used, it is to be connected through a double pole switch of appropriate rating. In no case a socket-outlet of rating higher than 15 A is to be installed.

**Determination of Total Load :** For the determination of the total load of an installation the following rating may be assumed unless the values are known or specified.

Fluorescent lamps (choke type): 40 W

Incandescent lamps: 100W

fans: 60W

socket outlets: 100 W

Power socket outlets: 1000 W

Exhaust fans (As per the capacity of exhaust fans)

**Determination of Number of Sub-Circuits:** In one light and fan sub-circuit, the maximum load that can be connected is 800 W and the maximum number of points, which can be wired is 10.

In one power sub-circuit, the maximum load that can be normally connected is 3000 W and the number of socket outlets, which can be provided is 2.

**Determination of Ratings of Main Switch And Distribution Board**

The current rating of the main switch is decided as per the total current of the circuit to be controlled by it.

The number of ways and current rating of the distribution board is decided as per the number of sub-circuits to be connected to it and the current of the sub-circuit having the highest current rating ∴

**For determination of a load of an installation, if not specified, the rating assumed for the power socket outlet is 1000 W.**

**Table : Current Rating of Copper Conductor Single Core Cables**  
(VIR, PVC or Polythene insulated including tough rubber sheathed, PVC or lead sheathed)

Size of conductors		Two cables d.c. or Single Phase a.c.		Three or four cables balanced three phase a.c.	
Nominal area mm <sup>2</sup>	No. and dia. of wire (mm)	Current Rating (amps)	Approximate length of run for one volt drop (mt)	Current Rating (amps)	Approximate length of run for one volt drop (mt)
1.0	1/1.12	5	2.9	3	2.8
1.5	3/1.737	10	3	10	3.7
2.5	3/1.06	15	3.4	13	4.3
4.0	7/1.737	20	3.7	15	4.8
6.0	7/1.06	28	4.0	25	5.2
8.0	7/1.12	36	4.9	32	6.1
10.0	7/1.40	43	5.5	39	7.0
15.0	7/1.63	52	7.0	48	8.8
20.0	19/1.12	62	7.6	56	9.8
25.0	19/1.40	74	8.8	67	11.3
35.0	19/1.63	97	10	88	12.8
50.0	19/1.80	160	19.4	155	13.4

**Table : Current Rating of Aluminium Conductor Single Core Cables**  
(VIR, PVC or Polythene insulated including tough rubber, PVC or lead sheathed)

Size of Conductor		Two cable d.c. or single phase a.c.		Three or four cables balanced three phase		Four cables d.c. or single phase a.c.	
Nominal area (mm <sup>2</sup> )	No. and dia. of wire (mm)	Current Rating (amps)	Approx run for one volt drop (Mt)	Current Rating (amps)	Approx run for one volt drop (mt)	Current Rating (amps)	Approx. run for volt drop (mt)
1.5	1/1.40	10	2.3	9	2.9	9	2.5
2.5	1/1.80	15	2.5	12	3.6	11	3.4
4	1/2.24	20	2.9	17	3.9	15	4.1
6	1/2.80	27	3.4	24	4.3	21	4.3
10	1/3.55	34	4.3	31	5.4	27	5.4
16	7/1.70	43	5.4	38	7.0	35	6.8
25	7/2.24	59	6.8	54	8.5	48	8.5
35	7/2.50	69	7.2	62	9.8	55	9.0
50	7/3.00	91	7.9	82	10.1	69	10.0
	19/1.80						
70.0	19/2.24	134	8.0	131	9.5	—	—
95.0	19/2.50	153	8.8	152	10.0	—	—

**Table : Current Rating of Copper Conductor Twin, Three Core and Four Core Cables**

Three core and Four core cables (VIR, PVC or Polythene insulated and sheathed with tough rubber, PVC or lead sheathed).

Size of conductor		One twin core cable d.c. or single phase a.c.		One three core or four core cable balanced three phase	
Nominal area (mm <sup>2</sup> )	No. and dia. of wire (mm)	Current rating (amps)	Approx. run for one volt drop (mt.)	Current Rating (amps)	Approx. run for one volt drop (mt.)
1.0	1/1.12	5	2.6	5	5.5
1.5	3/1.727	10	3.0	8	5.5
2.5	3/1.06	15	3.0	10	5.5
4.0	7/1.737	20	3.4	15	5.5
6.0	7/1.06	28	4.0	20	6.4
8.0	7/1.12	36	4.6	25	7.6
10.0	7/1.40	43	5.2	30	8.8
15.0	7/1.63	53	6.4	37	11.0
20.0	9/1.12	62	7.0	43	11.9
25.0	19/1.40	74	8.2	52	13.7
35.0	19/1.63	97	9.8	68	15.8
50.0	19/1.80	140	11.3	88	18.3

**Table : Current Rating of Aluminium Conductor Twin, Three Core or Four Core Cables**  
(VIR, PVC or Polythene insulated and sheathed with tough rubber, PVC or lead sheathed).

Size of conductor		One twin core cable d.c. or single phase a.c.		One three-core or four core cable balanced three phase	
Nominal area (mm <sup>2</sup> )	No. and dia. of wire (mm)	Current rating (amps)	Approx. length of run for one volt drop (mt.)	Current rating (amps)	Approx. length of run for one (mt.)
1.5	1/1.40	10	2.3	7	3.7
2.5	1/1.80	15	2.5	11	3.9
4.0	1/2.24	20	2.9	14	4.8
6.0	1/2.80	27	3.4	19	5.5
10.0	1/3.55	34	4.2	24	6.8
16.0	7/1.70	43	5.3	30	8.7
25.0	7/2.24	59	6.6	42	10.8
35.0	7/2.50	69	7.1	48	11.7
50.0	7/3.00	91	7.7	62	13.1
	19/1.80				
70.0	16/2.24	118	9.0	82	14.7
95.0	19/2.50	135	9.8	94	15.7

## DOMESTIC WIRING(NUMERICAL)

**1.**

Prepare one estimate of materials required for conduit wiring for small domestic installation of one room with given plan with given light, fan & plug points and make suitable wiring Diagram.

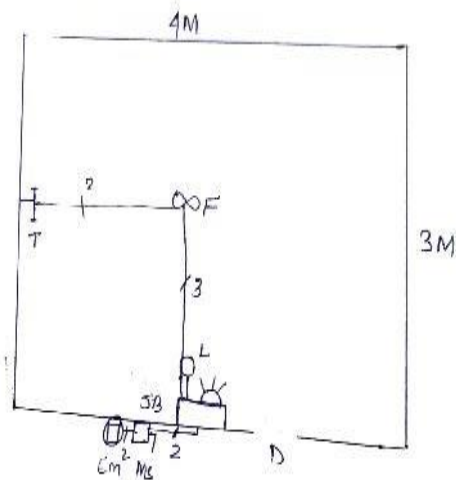

### **Assumption**

1. Height of ceiling from ground level-3.5m
2. Height of meter, switch board from ground-1.5m
3. Height of HR from SB -1.5m
4. Height of Ceiling from HR-0.5m
5. All load as per IER-1956

### **LOAD CALCULATION**

Sl no	Name of Load	Wattage	Qty	Total Load
1	Lamp	100w	1	1×100=100w
2	T.L	40W	1	1×40=40W
3	Fan	60w	1	1×60=60W
4	5A Socket	100w	1	1×100=100W
		Total Load		300w

Load Current= $300w/230v=1.3A$

### **Selection and rating of Main switch**

It is suggested that 16A,250V,DPIC Single phase Main switch is to be selected.

### **Selection and rating of Copper Conductor**

It is suggested that 5A,250V,1/1.12mm,1mm<sup>2</sup> Single core pvc insulated 1v drop per 4.9m copper conductor is to be selected.

### **Selection and Size of Conduit Pipe**

It is suggested that ½" Diameter PVC Conduit Pipe is to be selected.

## Wiring Diagram

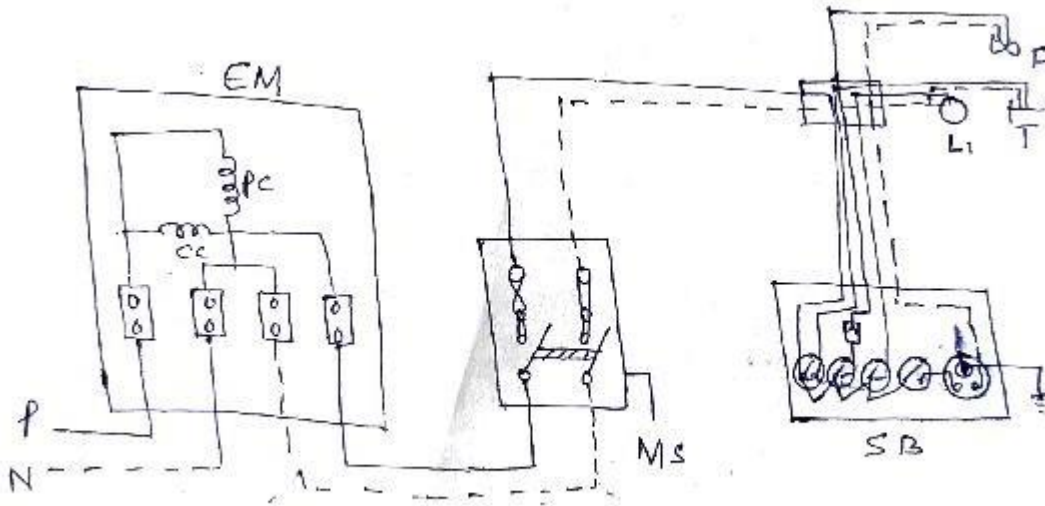

## Calculation of Length of wire ,conduit length and other material required.

LOCATION POINT	No. of Wire	Length of wire in M				Total Length	Total Conduit Length	No. of SB	No. of JB	No. of Elbow	Ceiling rose
		VR	HR	CR	WC						
From EM to MS	02		0.5			1	0.5(Flexible)				
From MS to JB	02	0.5			0.25	1.5	0.75		1(3way)	1	
From JB to SB	05	1.5				7.5	1.5	1(15×20cm)			
From JB to FAN	03	0.5		1.5		6	2			1	1
From Fan to TL	02	0.5		2		5	2.5			1	1

Length of Single core copper conductor Required= $1+1.5+7.5+6+5=21\text{m}$

Taking 10% wastage= $21 \times 0.1=2.1$

Total Length of Single core copper conductor required(Including Phase and Neutral )= $21+2.1=23.1\text{m}$

Length of  $\frac{1}{2}$ " PVC Conduit pipe Required= $0.75+1.5+2+2.5=6.75\text{m}$

Taking 10% wastage= $6.75 \times 0.1=0.67$

Total Length of  $\frac{1}{2}$ " PVC Conduit pipe Required=  $6.75+0.67=7.42\text{m}$



**BILL OF MATERIAL REQUIRED**

SI No	Name of Items	Specification	Qty	Price For Unit	Total cost
1	Main Switch	16A,250V,DPIC, 1-phase	1	600.00	600.00
2.	Single core Copper Conductor	5A,250V,1/1.12mm,1mm <sup>2</sup>	23.1m	10/m	231.00
3.	Conduit pipe	½" PVC	7.42m	10/m	75.00
4.	Switch Board	PVC(15×20cm)	1	50/PC	50.00
5.	JB	3WAY PVC	1	30/PC	30.00
6.	Switch	1 way, 5A	4 NO	25/NO	100.00
7.	Socket	5A,3PIN, 100W	1 No	30/no	30.00
8.	Ceiling Rose	Single phase	2no	40/no	80.00
9.	Lamp	250v,100w	1 no	12/no	12.00
10.	Tube Light set	40w,250v choke-40w	1 set	300/set	300.00
11.	Ceiling Fan with Regulator	60w,250v	1 set	1400/set	1400.00
12.	Pandent Holder		1 no	20/pc	20.00
13.	Elbow	Pvc,1/2"	3no	1/pc	3.00
14.	Earthing Wire	8swg	2m	20/m	40.00
15.	Flexible pipe	½" PVC	1m	10/m	10.00
16	PVC Tape	RED,BLACK	1NO EACH	10/m	20.00
			Total cost		2891.00
16.	Contingency charges(10%)				289.00
17	Inspection charges(5%)				145.00
18	Labor Charges(10%)				289
			Total Bill		3614.00

**Q-2: Prepare one estimate of materials required for conduit wiring for small domestic installation of Two room and one verandah with given plan with given light, fan & plug points and make suitable wiring Diagram.**

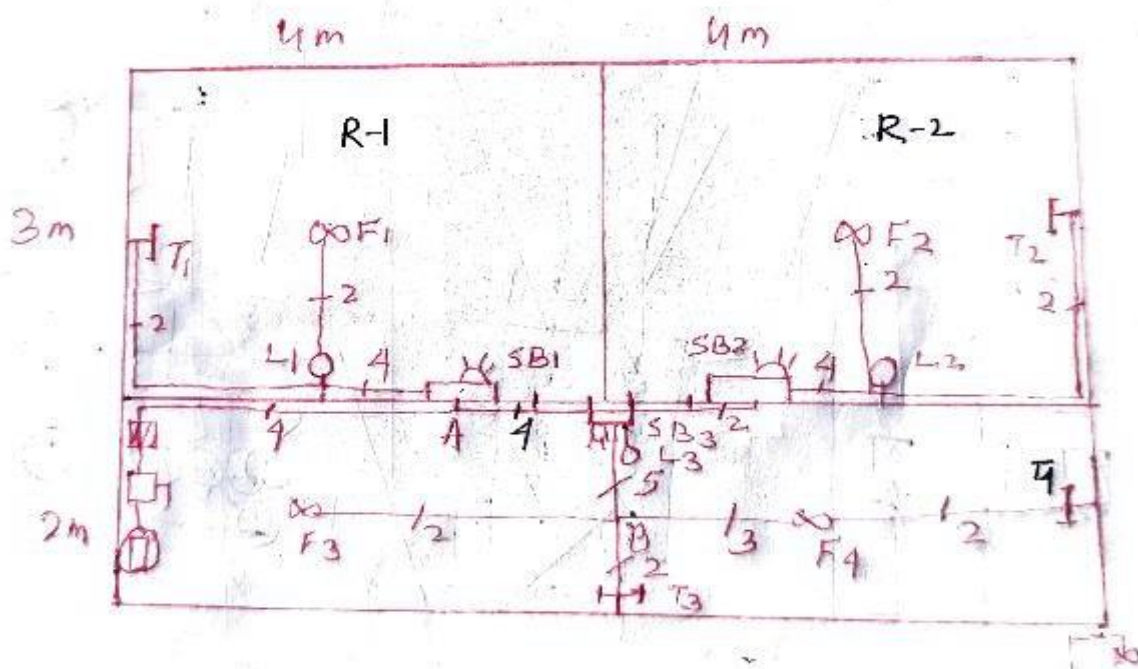
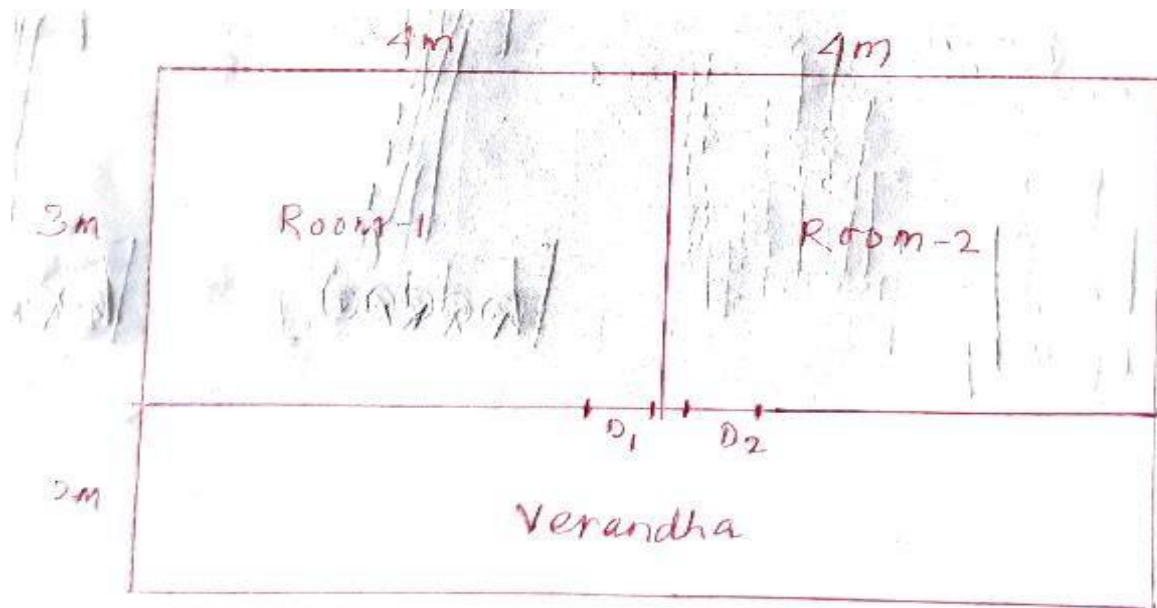

### Assumption

1. Height of ceiling from ground level-3.5m
2. Height of meter, switch board from ground-1.5m
3. Height of HR from SB -1.5m
4. Height of Ceiling from HR-0.5m
5. All load as per IER-1956

### LOAD CALCULATION

Sl no	Name of Load	Wattage	Qty	Total Load
1	Lamp	100w	3	3×100=300w
2	T.L	40W	4	4×40=160W
3	Fan	60w	4	4×60=240W
4	5A Socket	100w	3	3×100=300W
		Total Load		1000w

Load Current= $1000\text{w}/230\text{v}=4.34\text{A}$

**Selection and rating of Main switch**

It is suggested that 16A,250V,DPIC Single phase Main switch is to be selected.

**Selection and rating of Copper Conductor**

It is suggested that 10A,250V,3/0.737mm,1.5mm<sup>2</sup> Single core pvc insulated 1v drop per 3m copper conductor is to be selected for sub circuit.

It is suggested that 5A,250V,1/1.12mm,1mm<sup>2</sup> Single core pvc insulated 1v drop per 4.9m copper conductor is to be selected for Light and Fan circuit.

**Selection and Size of Conduit Pipe**

It is suggested that ½" and 1" Diameter PVC Conduit Pipe is to be selected.

**Selection and rating of BDB**

As we calculate Total load of a house is 1000w, hence the no. of sub circuit is required- $1000/800=2$

Because one sub circuit is provided for 800w.

Hence It is suggested that 250V, 50hz, 16A Copper Bus bar with 5way BDB is to be selected including Future extension.

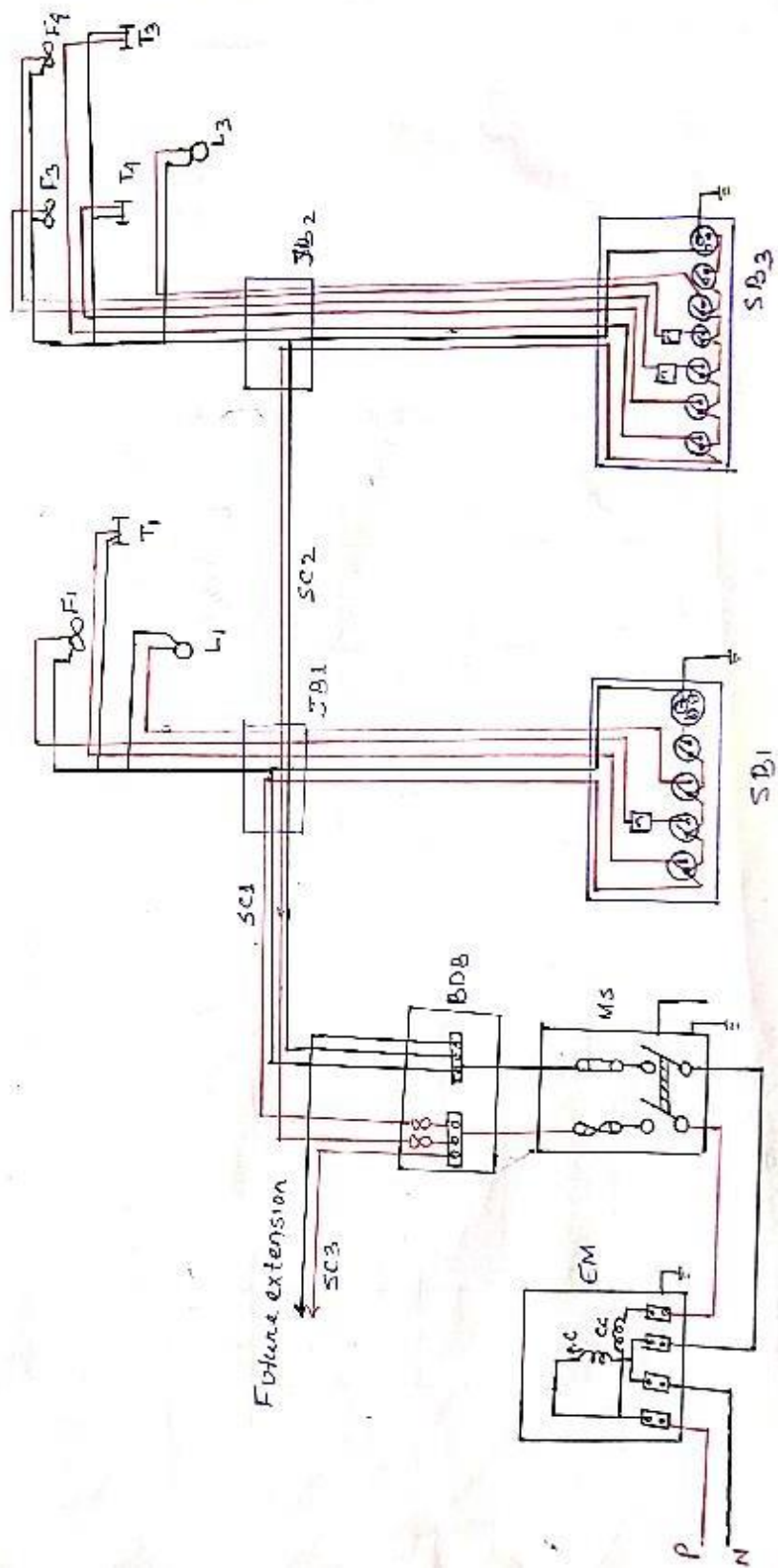

Wiring Diagram

**Calculation of Length of wire ,conduit length and other material required.**

LOCATION POINT	No. of Wire	Length of wire in M				Total Length		Total Conduit Length	No. of SB in CM	No. of JB/BDB	No. of Elbow	Ceiling rose
		VR	HR	CR	WC	10A	5A					
From EM to MS	02		0.25			0.5		0.25(Flexible)				
From MS to BDB	02		0.25			0.5		0.25(Flexible)		1(3way) BDB		
From BDB to A	04	1.5	3				18	4.5		1(3way)	1	
From A to JB1	2				0.25		0.5	2		1(4way)		
From JB1 to SB1	5	1.5					7.5	1.5	1(15×20)			
From JB1 to L1	4		1				4	1				
From L1 to F1	2	0.5		1.5			4	2			1	1
From L1 to T1	2		3.5				7	3.5			1	1
From A to JB3	4		1			4		1		1(4way)		
From JB3 to SB3	7	1.5					10.5	1.5	1(15×25)			
From JB3 to B	5	0.5		1			7.5	1.5		1(4way)	1	
From B to F3	2			2			4	2				1
From B to F4	3			2			6	2				1
From F4 to T4	2	0.5		2			5	2.5			1	1
From JB3 to JB2	2		1		0.25	2.5		1.25		1(3way)	1	
From JB2 to SB2	5	1.5					7.5	1.5	1(15×20)			
From JB2 to L2	4		1				4	1				
From L2to F2	2	0.5		1.5			4	2			1	1
From L2 to T2	2		3.5				7	3.5			1	1

Length of Single core 1.5mm<sup>2</sup>,10A copper conductor Required=6.5m

Taking 10% wastage= 6.5×0.1=0.65

Total Length of Single core 1.5mm<sup>2</sup>,10A copper conductor Required=6.5m+0.65=7.15m

Length of Single core copper conductor Required=96.5m

Taking 10% wastage= 96.5×0.1=9.65m

Total Length of Single core copper conductor required(Including Phase and Neutral )=96.5+9.65=106.15m

Length of ½" PVC Conduit pipe Required=34.25m

Taking 10% wastage=34.25×0.1=3.4m

Total Length of ½" PVC Conduit pipe Required= 34.25+3.4=38m

**BILL OF MATERIAL REQUIRED**

SI No	Name of Items	Specification	Qty	Price For Unit	Total cost
1	Main Switch	16A,250V,DPIC, 1-phase	1	600.00	600.00
2.	BDB	16A,250V,3WAY	1	800.00	800.00
3.	Single core Copper Conductor	5A,250V,1/1.12mm,1mm <sup>2</sup>	106.15m	10/m	1061.50
4.	Single core Copper Conductor	10A,250V,3/0.737mm,1.5mm <sup>2</sup>	7.15m	15/m	107.00
5	Conduit pipe	½" PVC	38m	10/m	380.00
6	Switch Board	PVC(15×20cm) (15×25cm)	2 1	50/PC 80/pc	100.00 80.00

7	JB	3WAY PVC 4WAY PVC	2 3	30/PC 30/PC	60.00 90.00
8	Switch	1 way, 5A	14NO	25/NO	350.00
9	Socket	5A,3PIN, 100W	3No	30/no	90.00
10	Ceiling Rose	Single phase	7no	40/no	280.00
11	Lamp	250v,100w	3no	12/no	36.00
12	Tube Light set	40w,250v choke-40w	4 set	300/set	1200.00
13	Ceiling Fan with Regulator	60w,250v	4set	1400/set	5600.00
14	Pandent Holder		3no	20/pc	60.00
15	Elbow	Pvc,1/2"	8no	2/pc	16.00
16	Earthing Wire	8swg	2m	20/m	40.00
17	Flexible pipe	½" PVC	1m	10/m	10.00
18	PVC Tape	RED,BLACK	2NO EACH	10/m	40.00
			Total cost		11000.00
19	Contingency charges(10%)				1100.00
20	Inspection charges(5%)				550.00
21	Labor Charges(10%)				1100.00
			Total Bill		13750.00

**Q-3: Prepare one estimate of materials required for conduit wiring for domestic installation of given plan with given light, fan & plug points and use one Power socket in Kitchen and make suitable wiring Diagram.**

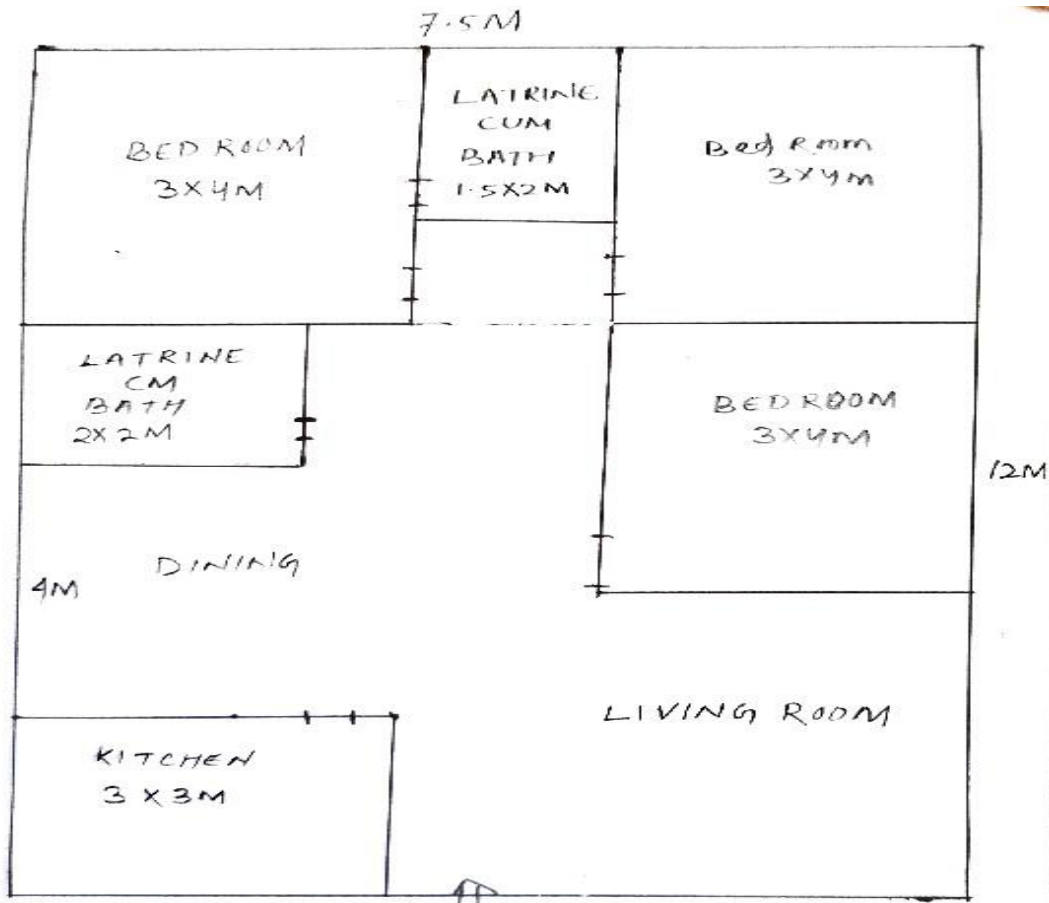

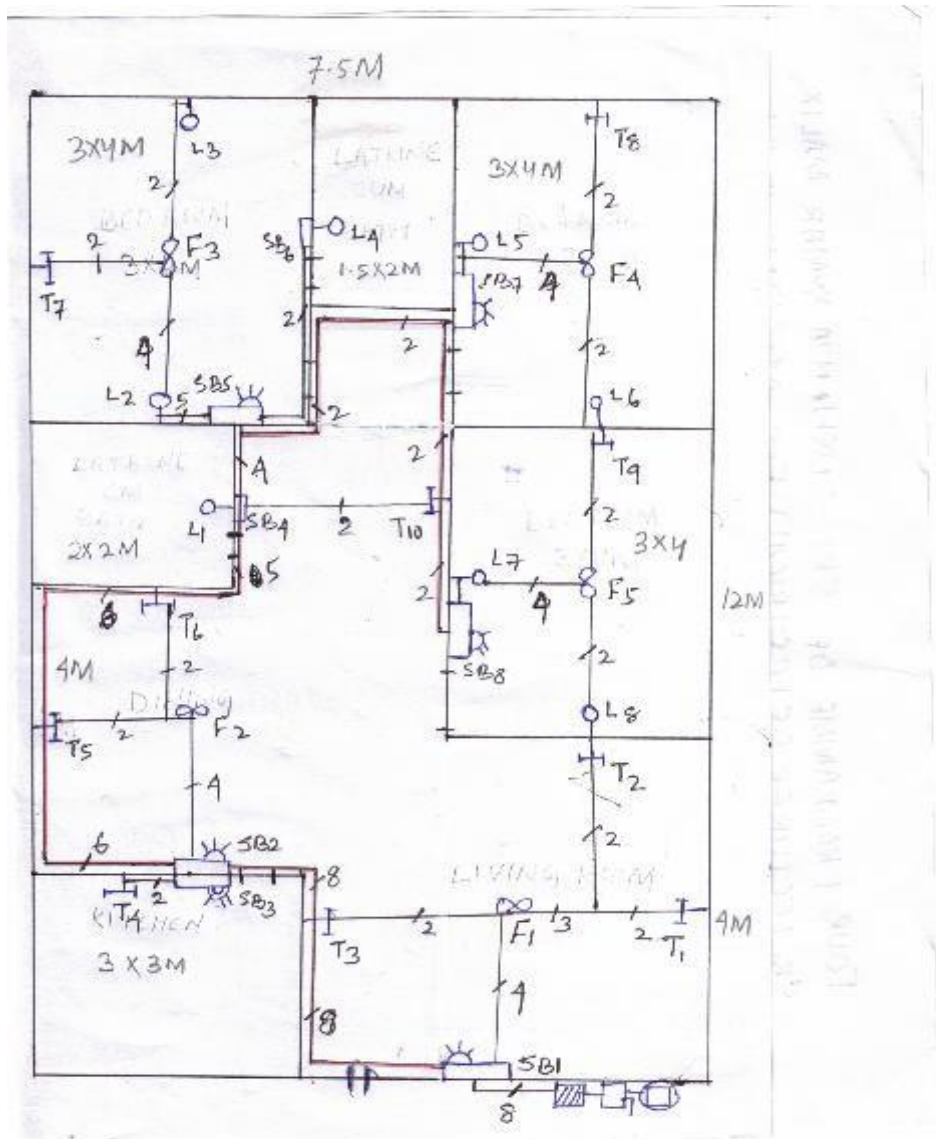

**Assumption**

1. Height of ceiling from ground level-3.5m
2. Height of meter, switch board from ground-1.5m
3. Height of HR from SB -1.5m
4. Height of Ceiling from HR-0.5m
5. All load as per IER-1956

## LOAD CALCULATION

Sl no	Name of Load	Wattage	Qty	Total Load
1	Lamp	100w	8	8×100=800w
2	T.L	40W	10	10×40=400W
3	Fan	60w	5	5×60=300W
4	5A Socket	100w	5	5×100=500W
5	15A Power socket	1000w	1	1×1000=1000w
		Total Load		3000w

Load Current= $3000w/230v=13.04A$

### Selection and rating of Main switch

It is suggested that 32A,250V,DPIC Single phase Main switch is to be selected.

### Selection and rating of Copper Conductor

It is suggested that 15A,250V,3/1.06mm,2.5mm<sup>2</sup> Single core pvc insulated 1v drop per 3.4m copper conductor is to be selected for sub circuit.

It is suggested that 5A,250V,1/1.12mm,1mm<sup>2</sup> Single core pvc insulated 1v drop per 4.9m copper conductor is to be selected for Light and Fan circuit.

### Selection and Size of Conduit Pipe

It is suggested that ½" and 1" Diameter PVC Conduit Pipe is to be selected.

### Selection and rating of BDB

As we calculate Total load of a house is 3000w, hence the no. of sub circuit is required- $3000/800=3.75=4$

Because one sub circuit is provided for 800w.

Hence It is suggested that 250V, 50hz, 32A Copper Bus bar with 5 way BDB is to be selected including one Future extension.

Sub Circuit1= Kitchen=1040w

Sub Cuircuit2=Dining Hall+ Latrine cum Bath=660w

Sub Cuircuit3= Bed room+ Latrine cum Bath=500w

Sub Cuircuit4=Bed Room2+Bed Room3=800w

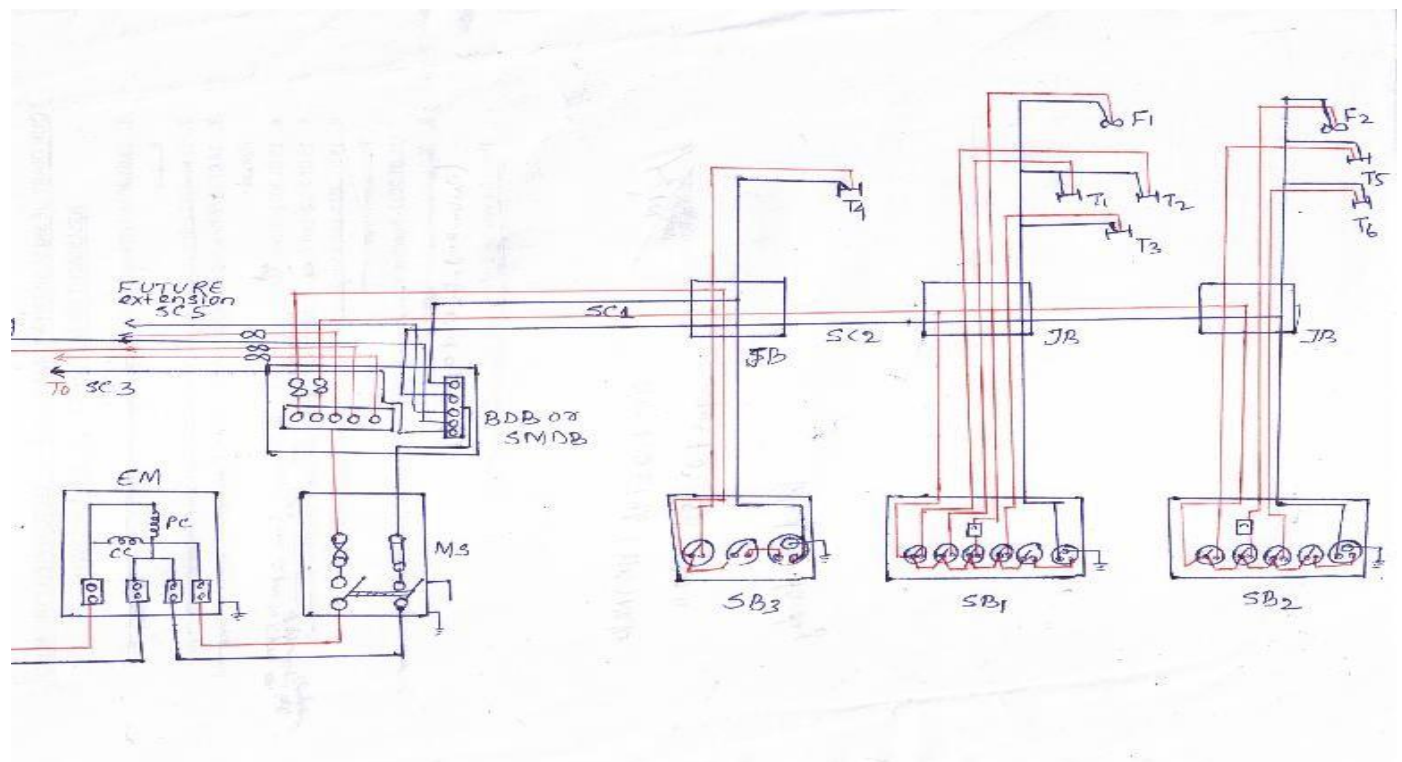



**Calculation of Length of wire ,conduit length and other material required.**

LOCATION POINT	No. of Wire	Length of wire in M				Total Length		Total Conduit Length	No. of SB in CM	No. of JB/BDB	No. of Elbow	Ceiling rose
		VR	HR	CR	WC	15A	5A					
From EM to MS	08		0.25			2		0.25(Flexible)				
From MS to BDB	08		0.25			2		0.25(Flexible)		1(5way) BDB		
From BDB to JB1	8	1.5	1.5		0.25	26		3.25		1(3way)	1	
From JB1 to SB1	6	1.5			0.25		9	1.5	1(15×20)			
From JB1 to F1	5	0.5		2			12.5	2.5		1(3way)	1	
From F1 to T3	2	0.5		2			5	2.5			1	
From F1 to JB	3			1			3	1		1(3way)		
From JB to T1	2	0.5		1			3	1.5			1	
From JB to T2	2	0.5		2			5	2.5			1	
From JB1 to JB2	8		5.5			44		5.5		1(4way)	2	
From JB2 to JB3	2				0.25	0.50		0.25		1(3way)		
From JB3 to SB3	3	1.5				4.5		1.5	1(10×15)			
From JB3 to T4	2		0.5				1	0.5			1	
From JB2 to SB2	5	1.5					7.5	1.5	1(15×20)			
From JB2 to F2	4	0.5		2			10	2.5			1	
From F2 to T5	2	0.5		3.5			8	4			1	
From F2 to T6	2	0.5		2			5	2.5			1	
From JB2to JB4	6		8.5			51		8.5		1(3way)	3	
From JB4 to SB4	3	1.5					4.5	1.5	1(10×15)			
From JB4 to L1	2				0.25		0.5	0.25				
From JB4 to T10	2	1	2				6	3			2	
From JB4 to JB5	4		1			4		1		1(3way)		
From JB5 to SB5	6	1.5					9		1(15×20)			
From JB5 to L2	5		0.5				2.5	0.5				
From L2 to F3	4	0.5		2			10	2.5			1	
From F3 to T7	2	0.5		1.5			4	2			1	
From F3 to L3	2	0.5		2			5	2.5			1	
From JB5 to JB6	2		2.5				5	2.5		1(3way)	1	
From JB6 to SB6	2	1.5					3	1.5	1(5×10)			
From JB5 to JB7	2		3.5			7		3.5		1(3way)	2	
From JB7 to SB7	6	1.5					9		1(15×20)			
From JB7 to L5	5		0.5				2.5	0.5				
From L5 to F4	4	0.5		1.5			8	2			1	
From F4 to T8	2	0.5		2			5	2.5			1	
From F4 to L6	2	0.5		2			5	2.5			1	
From JB7 to JB8	2		3			6		3		1(3way)		
From JB8 to SB8	6	1.5					9		1(15×20)			
From JB8 to L7	5		0.5				2.5	0.5				
From L7 to F5	4	0.5		1.5			8	2			1	
From F5 to T9	2	0.5		2			5	2.5			1	
From F5 to L8	2	0.5		2			5	2.5			1	

Length of Single core 15A,250V,3/1.06mm,2.5mm<sup>2</sup> copper conductor Required=147m

Taking 10% wastage= 147×0.1=14.7

Total Length of Single core 15A,250V,3/1.06mm,2.5mm<sup>2</sup> copper conductor Required=147m+14.7=161.7m

Length of Single core 5A,250V,1/1.12mm,1mm<sup>2</sup> copper conductor Required=177.5m

Taking 10% wastage= 177.5×0.1=17.75m

Total Length of Single core copper conductor required(Including Phase and Neutral )=177.5+17.75=195.25m

Length of ½" PVC Conduit pipe Required=80.25m

Taking 10% wastage=80.25×0.1=8.025m

Total Length of ½" PVC Conduit pipe Required= 80.25+8.025=88.3m

**BILL OF MATERIAL REQUIRED**

SI No	Name of Items	Specification	Qty	Price For Unit	Total cost
1	Main Switch	32A,250V,DPIC, 1-phase	1	900.00	900.00
2.	BDB	32A,250V,5WAY	1	1000.00	1000.00
3.	Single core Copper Conductor	5A,250V,1/1.12mm,1mm <sup>2</sup>	195.25m	10/m	1953.00
4.	Single core Copper Conductor	15A,250V,3/0.737mm,1.5mm <sup>2</sup>	161.7m	15/m	2430.00
5	Conduit pipe	½" PVC	88.3m	10/m	883.00
6	Switch Board	PVC(15×20cm) (10×15cm) (5×10cm)	5 2 1	50/PC 40/pc 30/pc	250.00 80.00 30.00
7	JB	3WAY PVC 4WAY PVC	9 1	30/PC 30/PC	180.00 30.00
8	Switch	1 way, 5A 15A	28NO 1 no	25/NO 80/pc	700.00 80.00
9	Socket	5A,3PIN, 100W 15A, 3pin, 1000w PS	5No 1 NO	30/no 90/PC	150.00 90.00
10	Ceiling Rose	Single phase	15no	40/no	600.00
11	Lamp	250v,100w	8no	12/no	96.00
12	Tube Light set	40w,250v choke-40w	10 set	300/set	3000.00
13	Ceiling Fan with Regulator	60w,250v	5set	1400/set	7000.00
14	Pandent Holder		8no	20/pc	160.00
15	Elbow	Pvc,1/2"	27no	2/pc	54.00
16	Earthing Wire	8swg	16m	20/m	320.00
17	Flexible pipe	½" PVC	1m	10/m	10.00
18	PVC Tape	RED,BLACK	4NO EACH	10/m	80.00
			Total cost		20049.00
19	Contingency charges(10%)				2000.00
20	Inspection charges(5%)				1000.00
21	Labor Charges(10%)				2000.00
			Total Bill		25049.00

**Table 5.3. Showing Number of wires which can be carried over a particular size of batton**

Size of batton (Width × Thickness)	Number and size of link clip required	Number of wires of size 1/1.40 mm dia, single core, aluminium conductor that can be laid
13 mm × 13 mm	1 × 38 mm	2
19 mm × 13 mm	1 × 50 mm	3
25 mm × 13 mm	2 × 38 mm	4
31 mm × 13 mm	[ 1 × 38 mm and 1 × 50 mm	5
37 mm × 13 mm	3 × 38 mm	6
44 mm × 13 mm	[ 2 × 38 mm and 1 × 50 mm	7
50 mm × 13 mm	[ 1 × 38 mm and 2 × 50 mm	8
56 mm × 13 mm	3 × 50 mm	9
61 mm × 13 mm	[ 2 × 38 mm and 2 × 50 mm	10
67 mm × 13 mm	[ 1 × 38 mm and 3 × 50 mm	11
75 mm × 13 mm	4 × 50 mm	12

**Q-4: Prepare one estimate of materials required for Batten wiring for domestic installation of given plan with given light, fan & plug points assume total load of house is 1500w with a suitable calculation of no of load required and make suitable wiring Diagram.**

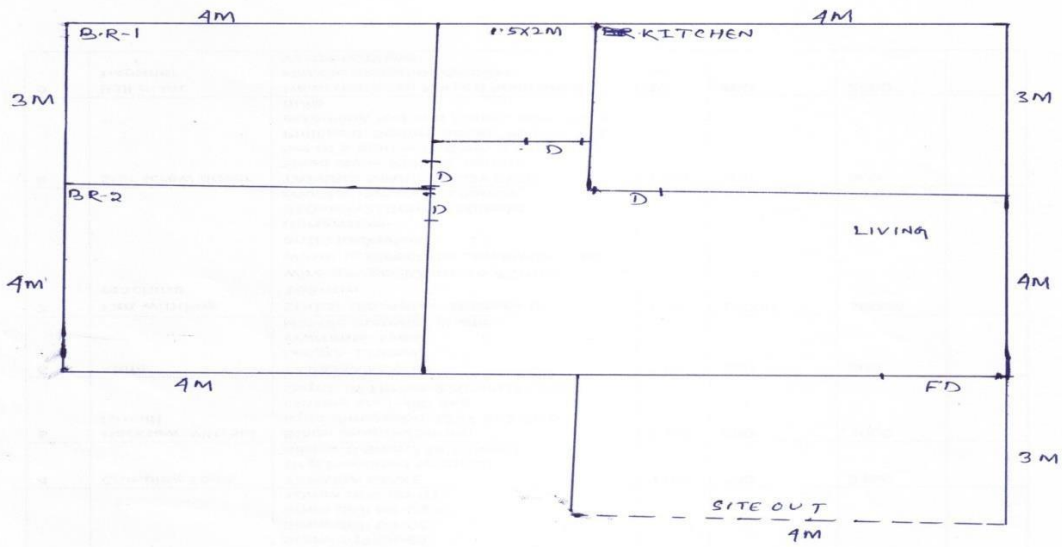

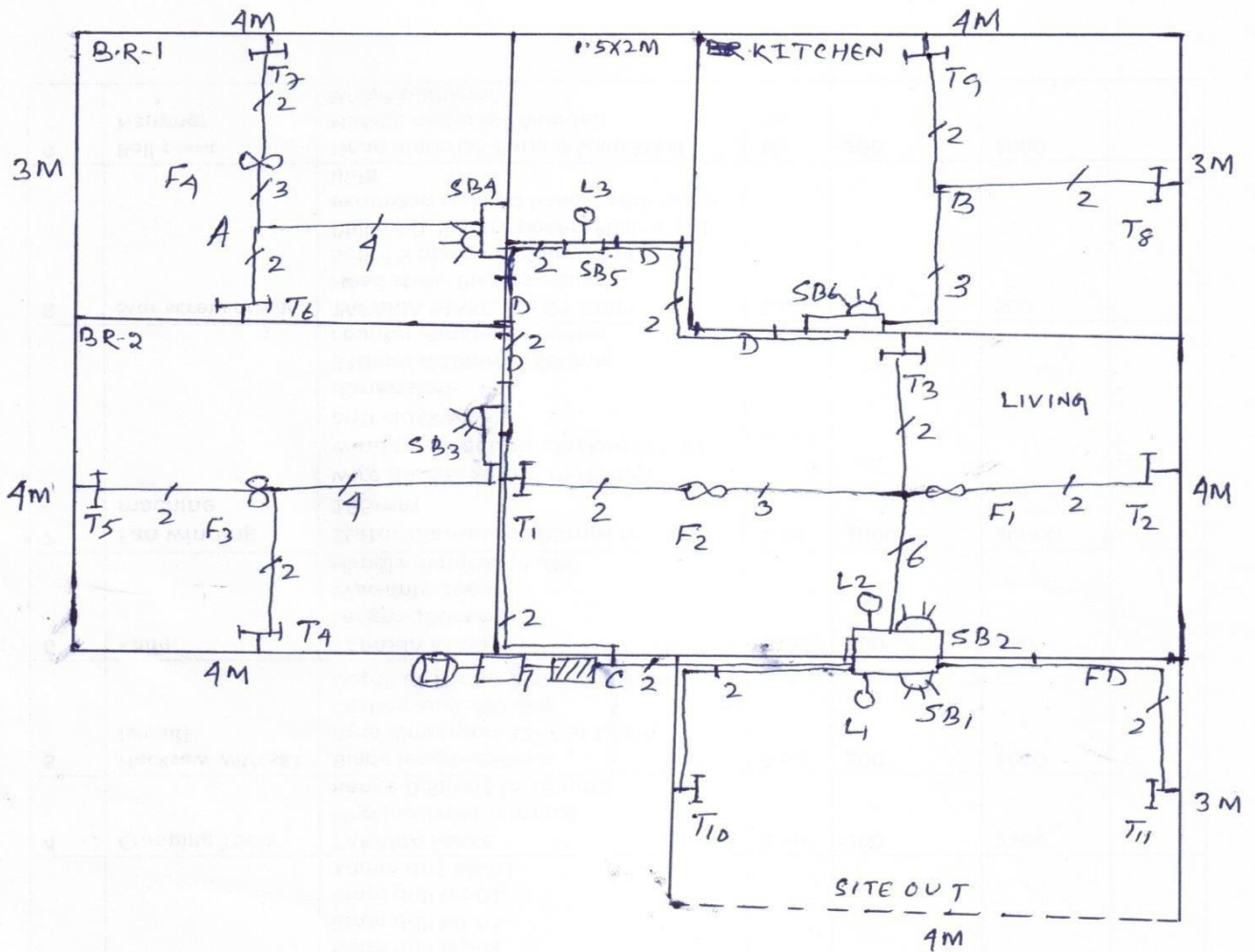

### Assumption

1. Height of ceiling from ground level-3.5m
2. Height of meter, switch board from ground-1.5m
3. Height of HR from SB -1.5m
4. Height of Ceiling from HR-0.5m
5. All load as per IER-1956

### LOAD CALCULATION

Sl no	Name of Load	Wattage	Qty	Total Load
1	Lamp	100w	3	3×100=300w
2	T.L	40W	11	11×40=440W
3	Fan	60w	4	4×60=240W
4	5A Socket	100w	5	5×100=500W
		Total Load		1480w

Load Current= $1480w/230v=6.43A$

### Selection and rating of Main switch

It is suggested that 16A,250V,DPIC Single phase Main switch is to be selected.

### Selection and rating of Copper Conductor

It is suggested that 10A,250V,3/1.06mm,1.5mm<sup>2</sup> Single core pvc insulated 1v drop per 3.4m copper conductor is to be selected for sub circuit.

It is suggested that 10A,250V,3/0.737mm,1.5mm<sup>2</sup> Single core pvc insulated 1v drop per 3m copper conductor is to be selected for Light and Fan circuit.

**Selection and rating of BDB**

As we calculate Total load of a house is 1480w, hence the no. of sub circuit is required- $1480/800=1.85=2$

Because one sub circuit is provided for 800w.

Hence It is suggested that 250V, 50hz, 16A Copper Bus bar with 3 way BDB is to be selected including one Future extension.

Sub Circuit1= LIVING AND SIDE OUT=720w

Sub Cuircuit2= BED ROOM1+BED ROOM2+KITCHEN+TOILET=760w

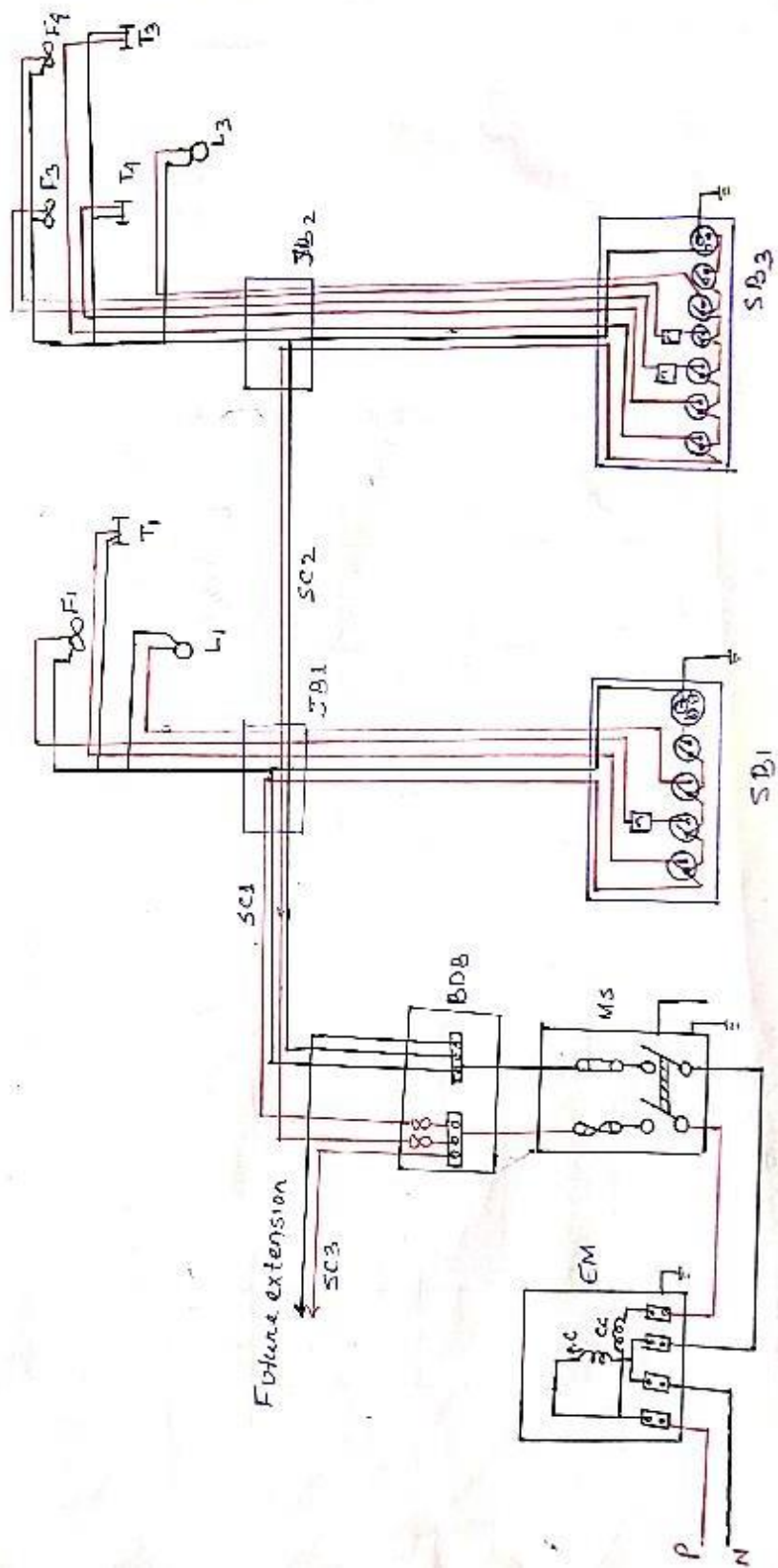

Wiring Diagram

**Calculation of Length of wire ,Batten length and other material required.**

LOCATION POINT	No. of Wire	Length of wire in M				Total Length Wire Required		Batten Length Required in mm						No. of SB in CM	No. of JB/BDB	Ceiling rose
		VR	HR	CR	WC			13×13 (2)	19×13 (3)	25×13 (4)	31×13 (5)	37×13 (6)	50×13 (8)			
						10A	5A									
From EM to MS	02		0.25			0.5		0.25								
From MS to BDB	02		0.25			0.5		0.25						1(3way) BDB		
From BDB to C	04	1.5	0.5			8				2				1(3way)		
From C to JB1	2		2.5			5		2.5						1(4way)		
From JB1 to SB1	5	1.5					7.5				1.5			1(15×20)		
From JB1 to T10	2		3.5				7	3.5								1
From JB1 to T11	2		3.5				7	3.5								1
From JB2 to SB2	8	1.5					12						1.5	1(4way)		
From JB2 to F1	6	0.5	2				15					2.5				
From F1 to T2	2	0.5	2				05	2.5								1
From F1 to T3	2	0.5	2				5	2.5								1
From F1to F2	3			2			6		2							1
From F2 to T1	2	0.5		1.5			4	2								1
From C to JB3	2	0.5		2		5		2.5						1(4way)		
From JB3 to SB3	5	1.5					7.5				1.5			1(15×20)		
From JB3 to F3	4	0.5		2			10			2.5						
From F3 to T4	2	0.5		2			5	2.5								1
From F3to T5	2	0.5		2			5	2.5								1
From JB3 to JB4	3		3			9			3					1(4way)		
From JB4 to SB4	5	1.5					7.5				1.5			1(15×20)		
From JB4 to A	4	0.5		2			10			2.5				1(3way)		
From A to T6	2	0.5		1			3	1.5								1
From A to F4	3			0.5			1.5		0.5							1
From F4 TO T7	2	0.5		1.5			4	2								1
From JB4to JB5	2		0.75			1.5		0.75						1(3way)		

From JB5to SB5	2	1.5				3	1.5							1(5×10)		
From JB5 to JB6	2		2.75			5.50	2.75								1(3way)	
From JB6 to SB6	4	1.5				6			1.5					1(15×20)		
From JB6 to B	3	0.5	0.5	1		6		2							1(3way)	
From B to T8	2	0.5	2			5	2.5									1
From B to T9	2	0.5	1.5			4	2									1

Length of Single core 10A,250V,3/1.06mm,2.5mm<sup>2</sup> copper conductor Required=35m

Taking 10% wastage= 35×0.1=3.5m

Total Length of Single core 10A,250V,3/1.06mm,1.5mm<sup>2</sup> copper conductor Required=35+3.5=38.5m

Length of Single core 5A,250V,1/1.12mm,1mm<sup>2</sup> copper conductor Required=146m

Taking 10% wastage= 146×0.1=14.6m

Total Length of Single core copper conductor required(Including Phase and Neutral )=146+14.6=160.6m

**LENGTH OF BATTEN REQUIRED**

Length of 13×13mm batten Required=37.5m

Taking 10% wastage=37.5×0.1=3.75m

Total Length of 13×13mm batten Required= 37.5+3.75=41.25m

Length of 19×13mm batten Required=7.5m

Taking 10% wastage=7.5×0.1=0.75m

Total Length of 19×13mm batten Required= 7.5+0.75=8.25m

Length of 25×13mm batten Required=8.5m

Taking 10% wastage=8.5×0.1=0.85m

Total Length of 25×13mm batten Required= 8.5+0.85=9.5m

Length of 31×13mm batten Required=4.5m

Taking 10% wastage=4.5×0.1=0.45m

Total Length of 31×13mm batten Required= 4.5+0.45=5m

Length of 37×13mm batten Required=2.5m

Taking 10% wastage=2.5×0.1=0.25m

Total Length of 37×13mm batten Required= 2.5+0.25=3m

Length of 50×13mm batten Required=1.5m

Taking 10% wastage=1.5×0.1=0.15m

Total Length of 50×13mm batten Required=1.5+0.15=2m



**BILL OF MATERIAL REQUIRED**

SI No	Name of Items	Specification	Qty	Price For Unit	Total cost
1	Main Switch	16A,250V,DPIC, 1-phase	1	900.00	900.00
2.	BDB	16A,250V,3WAY	1	1000.00	1000.00
3.	Single core Copper Conductor	5A,250V,1/1.12mm,1mm <sup>2</sup>	160M	10/m	1600.00
4.	Single core Copper Conductor	10A,250V,3/0.737mm,1.5mm <sup>2</sup>	38.5M	15/m	578.00
5	Well seasoned Teak wood batten required	13×13mm 19×13mm 25×13mm 31×13mm 37×13mm 50×13mm	41.25 8.25m 9.5m 5m 3m 2m	15/m 17/m 20/m 25/m 30/m 35/m	619.00 140.00 190.00 125.00 90.00 70.00
6	Switch Board	PVC(15×20cm) (5×10cm)	4 1	50/PC 30/pc	200.00 30.00
7	JB	3WAY PVC 4WAY PVC	5 3	30/PC 30/PC	150.00 90.00
8	Switch	1 way, 5A	23NO	25/NO	575.00
9	Socket	5A,3PIN, 100W	5No	30/no	150.00
10	Ceiling Rose	Single phase	13no	40/no	520.00
11	Lamp	250v,100w	3no	12/no	36.00
12	Tube Light set	40w,250v choke-40w	11set	300/set	3300.00
13	Ceiling Fan with Regulator	60w,250v	4set	1400/set	5600.00
14	Angle Holder		3no	20/pc	60.00
15	Batten clamp		100 no	2/pc	200.00
16	Earthing Wire	8swg	16m	20/m	320.00
17	Flexible pipe	½" PVC	1m	10/m	10.00
18	PVC Tape	RED,BLACK	4NO EACH	10/m	80.00
			Total cost		16633.00
19	Contingency charges(10%)				1663.00
20	Inspection charges(5%)				832.00
21	Labor Charges(10%)				1663.00
			Total Bill		20791.00

**Q-5: Prepare one estimate of materials required for PVC wiring for a single stored Boys Hostel installation of given plan with given light, fan & plug points and make suitable wiring Diagram.**

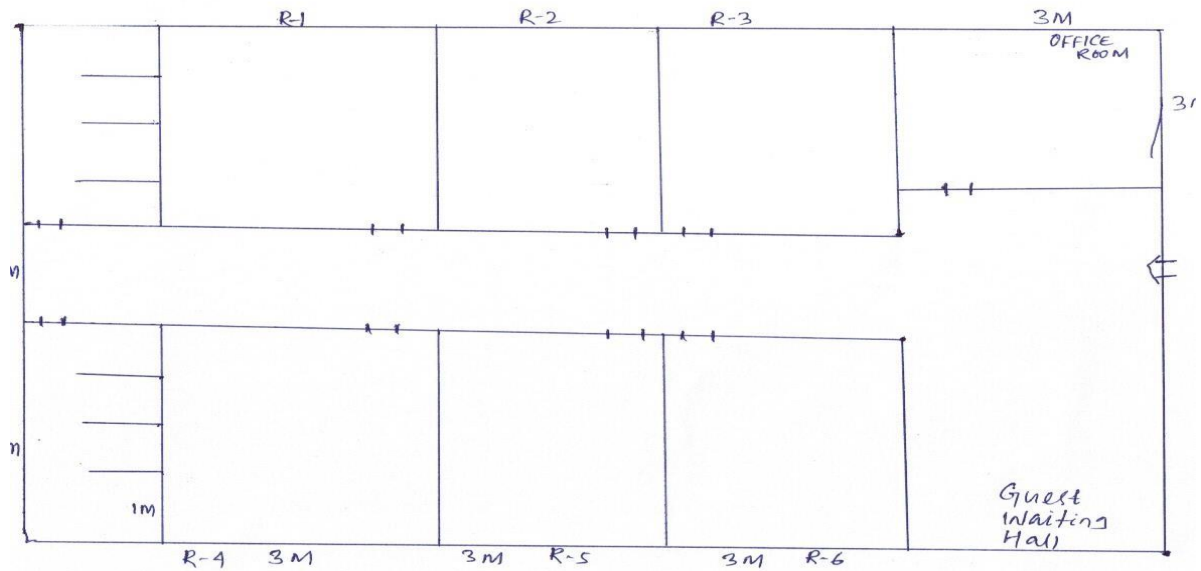

**Building Plan**

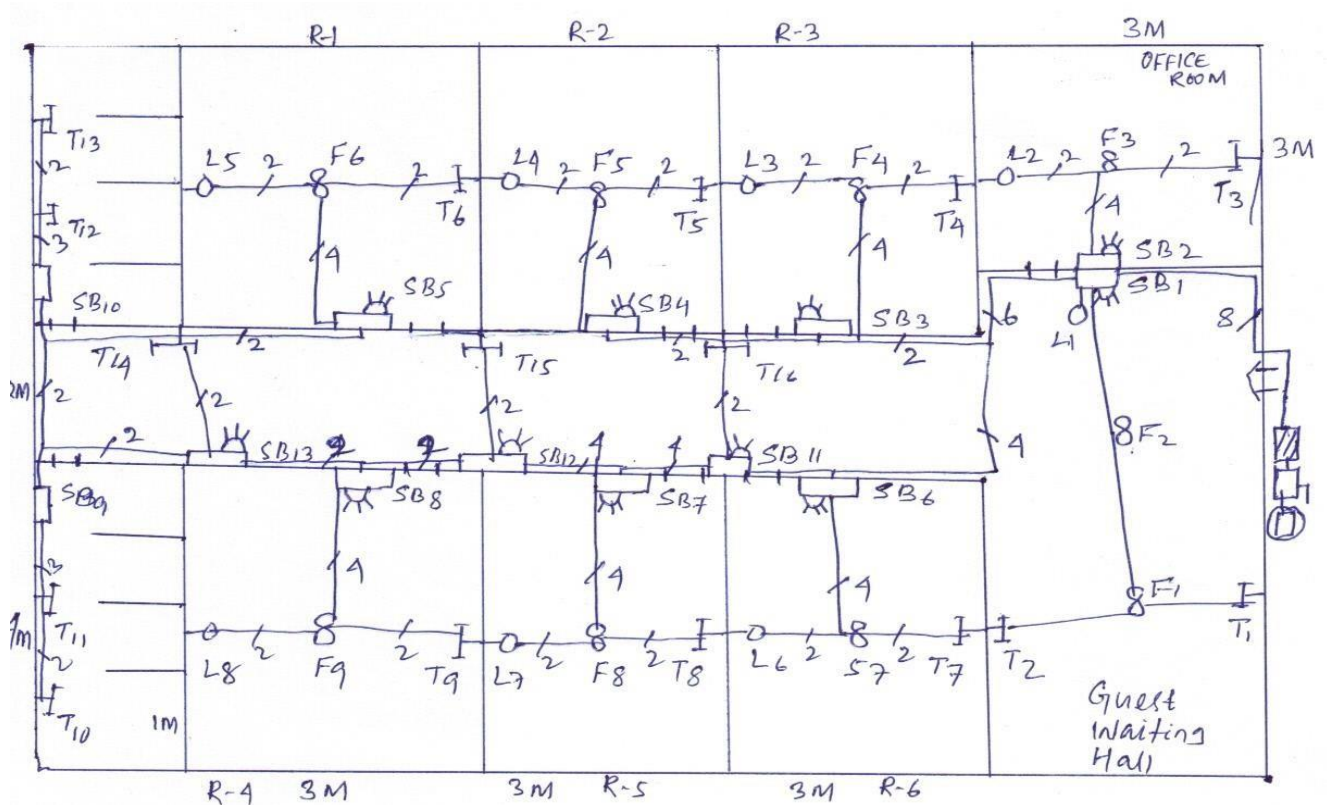

**ELECTRICAL WIRING PLAN**

### Assumption

1. Height of ceiling from ground level-3.5m
2. Height of meter, switch board from ground-1.5m
3. Height of HR from SB -1.5m
4. Height of Ceiling from HR-0.5m
5. All load as per IER-1956

### LOAD CALCULATION

Sl no	Name of Load	Wattage	Qty	Total Load
1	Lamp	100w	8	8×100=800w
2	T.L	40W	16	16×40=640W
3	Fan	60w	9	9×60=540W
4	5A Socket	100w	11	11×100=1100W
		Total Load		3080w

Load Current= $3080w/230v=13.39A$

### Selection and rating of Main switch

It is suggested that 32A,250V,DPIC Single phase Main switch is to be selected.

### Selection and rating of Copper Conductor

It is suggested that 15A,250V,3/1.06mm,2.5mm<sup>2</sup> Single core pvc insulated 1v drop per 3.4m copper conductor is to be selected for sub circuit.

It is suggested that 5A,250V,1/1.12mm,1mm<sup>2</sup> Single core pvc insulated 1v drop per 4.9m copper conductor is to be selected for Light and Fan circuit.

### Selection and Size of Conduit Pipe

It is suggested that ½" and 1" Diameter PVC Conduit Pipe is to be selected.

### Selection and rating of BDB

As we calculate Total load of a house is 30800w, hence the no. of sub circuit is required- $3080/800=4$

Because one sub circuit is provided for 800w.

Hence It is suggested that 250V, 50hz, 32A Copper Bus bar with 5 way BDB is to be selected including one Future extension.

Sub Circuit1= OFFICE ROOM+ GUEST ROOM=700W

Sub Cuircuit2=R2+R3+SB11 =740w

Sub Cuircuit3= R5+ R6+SB12=740w

Sub Cuircuit4=R1+R4+2 NO S OF LATRINE=900w

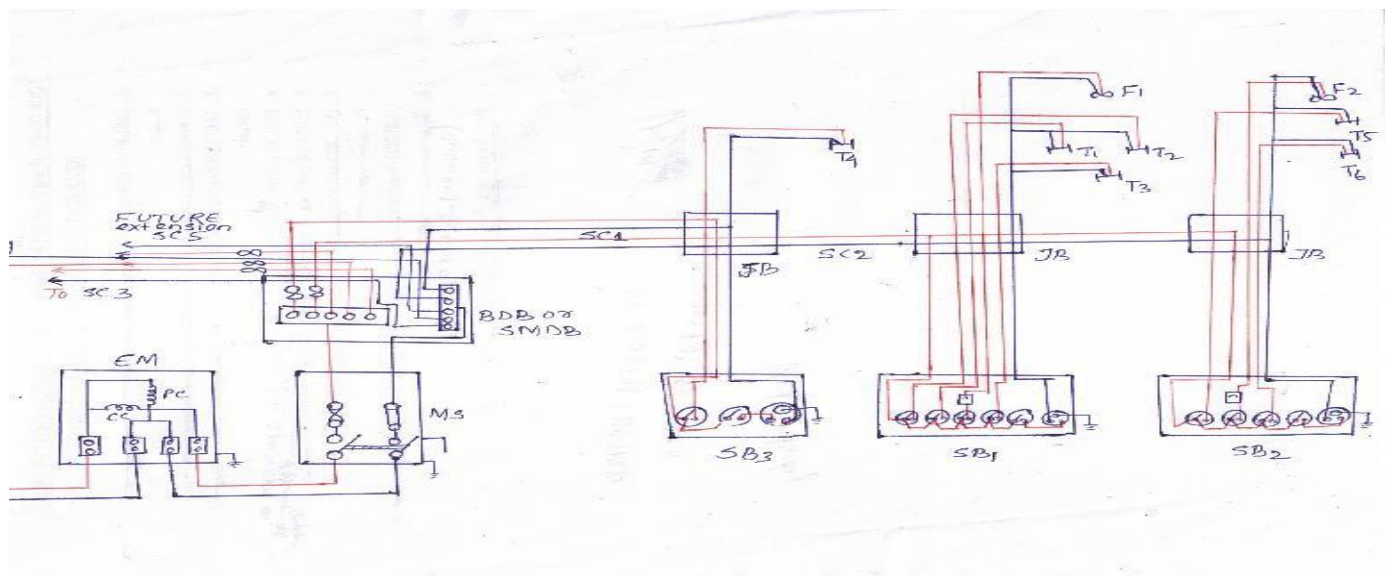

**Calculation of Length of wire ,conduit length and other material required.**

LOCATION POINT	N o. of W ir e	Length of wire in M				Total Length		Total Conduit Length	No. of SB in CM	No. of JB/BDB	No. of Elbo w	Ceili ng rose	
		VR	HR	CR	WC	15A	5A						
From EM to MS	08		0.25			2		0.25(Flexible)					
From MS to BDB	08		0.25			2		0.25(Flexible)		1(5way) BDB			
From BDB to JB1	8	1.5	4		0.25	46		5.5		1(3way)	2		
From JB1 to SB1	7	1.5					10.5	1.5	1(15×20)				
From JB1 to F2	5	0.5		2.5			15	3		1(3way)	1	1	
From F2 to F1	4			2			8	2			1	1	
From F1 to T1	2	0.5		1.5			4	2					
From F1 to T2	2	0.5		1.5			4	2			1	1	
From JB1 to JB2	2				0.25	0.5		0.25		1(4way)			
From JB2 to SB2	5	1.5					7.5	1.5	1(15×20)				
From JB2 to F3	4	0.5	1.5				8	2			1	1	
From F3 to T3	2	0.5		1.5			4	2			1	1	
From F3 to L2	2	0.5		1.5			4	2			1	1	
From JB1 to A	6		2.5			15		2.5		1(3way)			
From A to JB3	2		1.5			3		1.5		1(3way)			
From JB3 to SB3	5	1.5					7.5	1.5	1(15×20)				
From JB3 to F4	4	0.5	2				10	2.5			1	1	
From F4 to T4	2	0.5		1.5			4	2			1	1	
From F4 to L3	2	0.5		1.5			4	2			1	1	
From JB3 to JB4	2		3		0.25	6.5		3.25		1(3way)			
From JB4 to SB4	5	1.5					7.5	1.5	1(15×20)				
From JB4 to F5	4	0.5	2				10	2.5			1	1	
From F5 to T5	2	0.5		1.5			4	2			1	1	
From F5 to L4	2	0.5		1.5			4	2			1	1	
From A to JB6	4		3.5		0.25	15		3.75		1(3way)			
From JB6 to SB6	5	1.5					7.5	1.5	1(15×20)				
From JB6 to F7	4	0.5	2				10	2.5			1	1	
From F7 to T7	2	0.5		1.5			4	2			1	1	
From F7 to L6	2	0.5		1.5			4	2			1	1	
From JB6 to JB11	4		1.5			6		1.5		1(3way)			
From JB11 to SB11	3	1.5					4.5	1.5	1(10×15)				
From JB11 to T16	2	1	2				6	3			2	1	
From JB11to JB7	4		1.5		0.25	7		1.75		1(3way)			
From JB7 to SB7	5	1.5					7.5	1.5	1(15×20)				
From JB7 to F8	4	0.5	2				10	2.5			1	1	
From F8 to T8	2	0.5		1.5			4	2			1	1	
From F8 to L7	2	0.5		1.5			4	2			1	1	
From JB7 to JB12	2		1.5			3		1.5		1(3way)			
From JB12 to SB12	3	1.5					4.5	1.5	1(10×15)				
From JB12 to T15	2	1	2				6	3			2	1	
From JB12 to JB8	2		1.5		0.25	3.5		1.75		1(3way)			
From JB12 to SB8	5	1.5					7.5	1.5	1(15×20)				

From JB12 to F9	4	0.5	2				10	2.5			1	1	
From F9 to T9	2	0.5		1.5			4	2			1	1	
From F9 to L8	2	0.5		1.5			4	2			1	1	
From JB8 to JB13	2		1.5			3		1.5		1(3way)			
From JB13 to T14	2	1	2				6	3			2	1	
From JB13 to JB9	2		2.5			5		2		1(3way)			
From JB9 to SB9	3	1.5					4.5	1.5	1(10×15)				
From JB9 to T11	3		2				6	2				1	
From T11 to T10	2		1				3	1				1	
From JB9 to JB10	2		2		0.25		4.5	2.25		1(3way)			
From JB10 to SB10	3	1.5					4.5	1.5	1(10×15)				
From JB10 to T12	3		2				6	2				1	
From T12 to T13	2		1				3	1				1	
From JB10 to JB5	2		3.5		0.25	7.5		3.75		1(3way)			
From JB5 to SB5	5	1.5					7.5	1.5	1(15×20)				
From JB5 to F6	4	0.5	2				10	2.5			1	1	
From JB5 to T6	2	0.5		1.5			4	2			1	1	
From JB5 to L5	2	0.5		1.5			4	2			1	1	

Length of Single core 15A,250V,3/1.06mm,2.5mm<sup>2</sup> copper conductor Required=125m

Taking 10% wastage= 125×0.1=12.5m

Total Length of Single core 15A,250V,3/1.06mm,2.5mm<sup>2</sup> copper conductor Required=125m+12.5=138m

Length of Single core 5A,250V,1/1.12mm,1mm<sup>2</sup> copper conductor Required=251m

Taking 10% wastage= 251×0.1=25.1m

Total Length of Single core copper conductor required(Including Phase and Neutral )=251+25=276m

Length of ½" PVC Conduit pipe Required=120m

Taking 10% wastage=120×0.1=12m

Total Length of ½" PVC Conduit pipe Required= 120+12=132m

#### **BILL OF MATERIAL REQUIRED**

SI No	Name of Items	Specification	Qty	Approx.Price For Unit	Total cost
1	Main Switch	32A,250V,DPIC, 1-phase	1	900.00	900.00
2.	BDB	32A,250V,5WAY	1	1000.00	1000.00
3.	Single core Copper Conductor	5A,250V,1/1.12mm,1mm <sup>2</sup>	251m	10/m	2510.00
4.	Single core Copper Conductor	15A,250V,3/0.737mm,1.5mm <sup>2</sup>	138m	15/m	2070.00
5	Conduit pipe	½" PVC	132m	10/m	1320.00
6	Switch Board	PVC(15×20cm) (10×15cm)	8 4	50/PC 40/pc	400.00 160.00
7	JB	3WAY PVC 4WAY PVC	14 1	30/PC 30/PC	420.00 30.00
8	Switch	1 way, 5A	44NO	25/NO	1100.00
9	Socket	5A,3PIN, 100W	11No	30/no	330.00
10	Ceiling Rose	Single phase	34no	40/no	1360.00
11	Lamp	250v,100w	8no	12/no	96.00
12	Tube Light set	40w,250v choke-40w	16 set	300/set	4800.00
13	Ceiling Fan with	60w,250v	9set	1400/set	12600.00

	Regulator				
14	Pandent Holder		8no	20/pc	160.00
15	Elbow	Pvc,1/2"	27no	2/pc	54.00
16	Earthing Wire	8swg	90m	20/m	1800.00
17	Flexible pipe	½" PVC	1m	10/m	10.00
18	PVC Tape	RED,BLACK	6NO EACH	10/m	120.00
			Total cost		31240.00
19	Contingency charges(10%)				3124.00
20	Inspection charges(5%)				1562.00
21	Labor Charges(10%)				3124.00
			Total Bill		39050.00

### Selection and Rating of Cable

The selection and rating of cable depends upon current drawn by the motor at full load. There are two occasions when the motor draws more current than its rated capacity i.e. in the case of overloading and at the time of starting of motor. Let us first take the factor of starting current. When the motor is started, it draws current larger than full load current. Since the excess current is only for a short period, and in the case of larger motors, the starting current is limited by various starting devices. Therefore, the starting current need not to be taken into account for determining the size of wire or cable for the motor. As such, the size of wire or cable is determined as per full load current of the motor subject to overloading of the motor.

Now let us take the case of overloading of the motor. Small overloading of 5 to 10% are allowed for considerably less time. When the motor is made to run on overload, it will draw more current from the line and on account of overload, the pressure on cables will increase. Therefore 1.5 times the full load current is generally taken for selecting the wire or cable for the motor.

The aluminium conductor single core cable for various motors may be taken as under. The minimum size of conductor or cable for power wiring should not be less than 1/1.80 mm or 2.5 sq. mm.

**Table 18.1.**

BHP of motor	3 phase 400 volts	Rated current amp.	Starting or overload current amps.	Insulation	Metal	Single core cable recommended
1	400 volts	2	3	PVC	Al.	4.0 sq mm 1/2.24 mm dia minimum size.
3	400 volts	5	7.5	PVC	Al.	—do—
5	400 volts	8	12	PVC	Al.	6 mm <sup>2</sup> or 1/2.80 mm
7.5	400 volts	12	18	PVC	Al.	6 mm <sup>2</sup> or 1/2.80 mm
10	400 volts	15	22	PVC	Al.	10 mm <sup>2</sup> or 1/3.55 mm (Starting current limited by star delta starter)
15	400 volts	22	30	PVC	Al.	10 Sq. mm or 1/3.55 mm (Starting current limited by star/delta starter)
20	400 volts	29	35	PVC	Al.	16 Sq. mm or 7/1.70 mm (Starting current limited by star/delta starter)
30	400 volts	42	50	PVC	Al.	25 mm <sup>2</sup> or 7/2.24 mm (at 20% overload) starting current limited by auto-transformer starter
40	400 volts	56.5	68	PVC	Al.	35 mm <sup>2</sup> or 7/2.50 mm (at 20% overload) No starting current.
50	400 volts	71	85	PVC	Al.	50 mm <sup>2</sup> or 7/3.0 mm (at 20% overload) No starting current.

## WORKSHOP OR MOTOR INSTALLATION

1. It is proposed to install a power connection of 3 phase 5 HP motor for an agriculture tube –well in the room of size 3M×3M×3M high. The motor is 1 m away from two nearest wall. Prepare an estimate in the following order

i) Draw installation plan with showing MDB and motor

ii) SLD Showing earth wire also

iii) Wiring diagram

and prepare Bill of Material required.

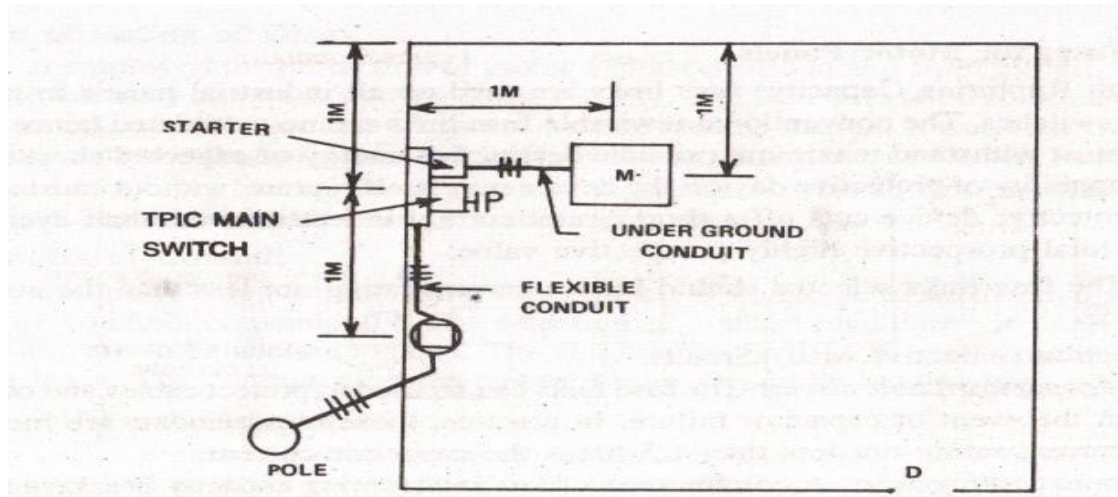

Assumption

1. Height of main board from floor-1.5m
2. Two earth wire required with 15mm dia GI pipe installed for earthing of the motor .
3. Plinth height from floor-0.25m

Calculation of Load=  $5 \times 735.5 / (\sqrt{3} \times 400 \times 0.75 \times 0.85) = 8A$

Taking 50% overload ,then Total load current drawn by the motor=8+4=12A

### Selection and rating of MS:

As total load current after taking overload is 12 A, It is suggested that 32A, TPIC,500V grade MS is to be selected.

### Selection and rating of Wire:

It is suggested that a PVC insulated aluminum conductor, single core. 660v grade 6mm<sup>2</sup>, 1/2.80 mm dia should be selected for power wiring.

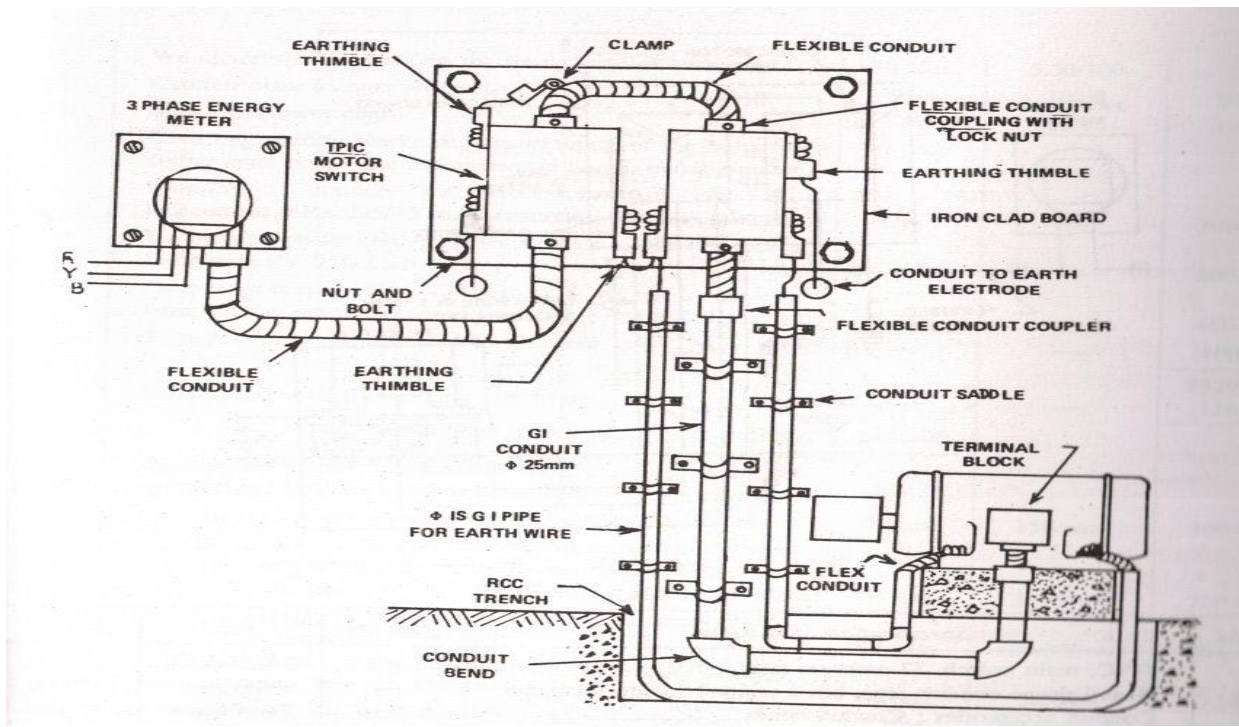

PROPER WIRING SCHEMATIC DIAGRAM

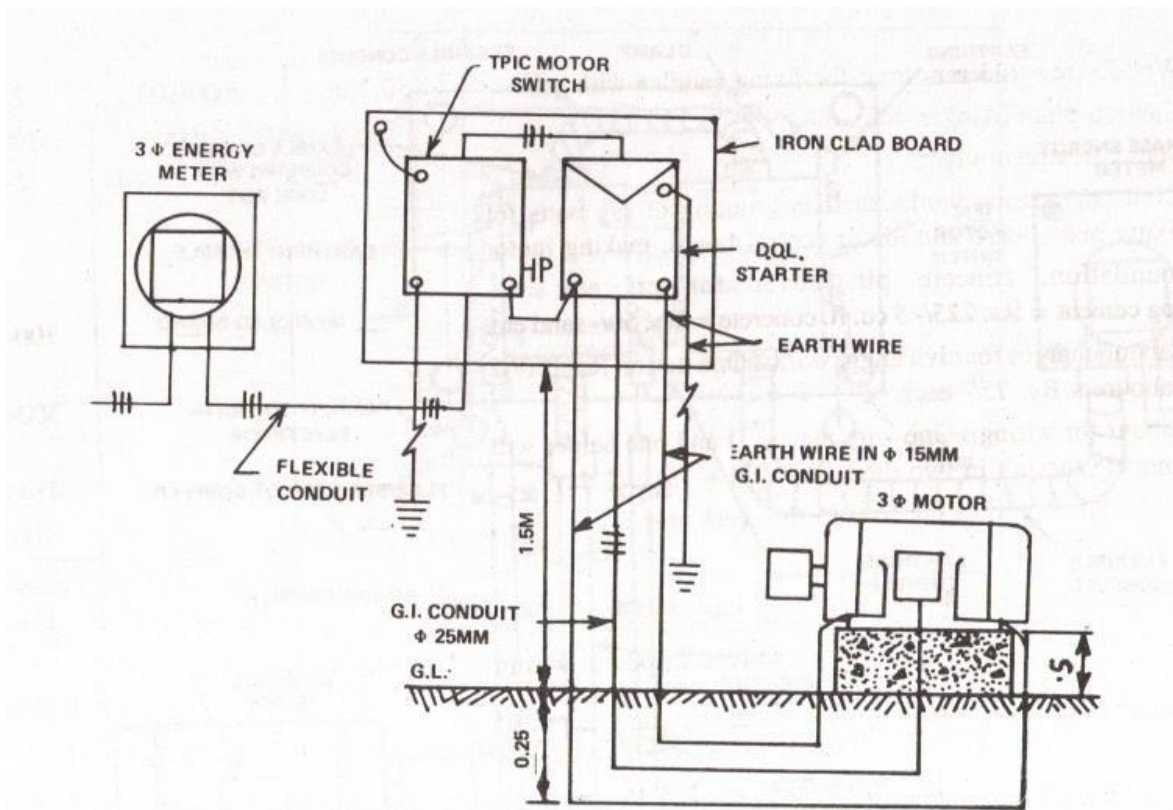

SINGLE LINE WIRING DIAGRAM

**Calculation for the length of heavy gauge conduit pipe, 25mm dia:**

From main board to Ground+ Depth of trench(both side)+along the trench+ Plinth Height

$$1.5\text{m} + 0.25\text{m} + 0.25\text{m} + 1 + 0.25 = 3.25\text{m}$$

$$\text{Taking 10\% wastage} = 3.25 \times 0.1 = 0.325$$

$$\text{Total length of pipe required} = 3.25 + 0.325 = 3.57 = 4\text{m}$$

**Calculation for the length of heavy gauge conduit pipe, 15mm dia for earth wire:**

$$\text{Length of heavy gauge pipe (25mm) dia without wastage} \times \text{no. of earth wire provided} = 3.25\text{m} \times 2 = 6.5\text{m}$$



Taking 10% wastage= $6.5 \times 0.1 = 0.65$

Total length of pipe required= $6.5 + 0.65 = 7.15$ M

**Calculation for the length of Flexible conduit pipe,25mm dia:**

**From EM to main board = 1m**

**From MS to Starter = 0.5m**

**From starter to Conduit mouth =0.25m**

**From motor foundation to motor terminal box = 0.25m**

**Total conduit required =2m**

**Taking 10% wastage=  $2 \times 0.1 = 0.2$ m**

**Total conduit required =2m+0.2 = 2.5M**

**Calculation for Length of Wire of 6mm<sup>2</sup>,1/2.80mm dia:**

**No. of wire** × length of conduit without wastage(Rigid and flexible)

$3 \times (3.25 + 2) = 15.75$ m

**Taking 10% wastage=  $15.75 \times 0.1 = 1.57$ m**

Total wire required =  $15.75 + 1.57 = 17$ m

**Calculation for Length of 8SWG, GI earth wire**

**2 earth wire** × length of 25mm dia conduit pipe without wastage+ 2m around main board

$(2 \times 3.25) + 2 = 8.5$ m

**BILL OF MATERIAL REQUIRED**

SL NO	SPECIFICATION OF MATERIAL	QUANTITY	RATE	AMOUNT
1	TPIC, MS,32A,500v	1 no	900/each	900.00
2	Heavy gauge conduit pipe,25mm dia	4mt	40/mt	160.00
3	Conduit Bend	2 no	10/each	20.00
4.	Conduit saddle	4 no	50/doz	16.00
5.	Heavy gauge conduit pipe,15mm dia	7mt	40/mt	280.00
6	Conduit Bend	4 no	10 /each	40.00
7	Conduit saddle	8 no	5/each	40.00
8	Conduit socket 15mm dia	2 no	20/each	40.00
9.	Flexible conduit 25mm dia	2.5m	20/mt	50.00
10	Flexible conduit coupler to join rigid and flexible conduit	2 no	15/each	30.00
11	Flexible conduit attachment with lock nuts to attach flexible conduit with MS, STARTER, motor	6 no	10/each	60.00
12	PVC insulated aluminum conductor, single core. 660v grade 6mm <sup>2</sup> , 1/2.80 mm dia	17mt	10/mt	170.00
13	8SWG, GI earth wire	9mt	5/mt	45.00
14	Iron clad board of size-30cm×45cm	1 no	300/each	300.00
15	Earthing Thimble16A with nut and bolt	10 no	5/each	50.00
16	Teak wood guttis for fixing conduit saddle with wall	30 no	2/each	60.00
17	Wood screws 25mm	30 no	50/100	15.00
18	Caution plate(440v)	1 no	100/each	100.00
19	Shock treatment chart	1 no	200/each	200.00
20	Civil work			500.00
21	Labour charges for 2 labor		350/each	700.00
22	Labour charges for wiring(1 skilled labour and one helper) for two days(350+250)2			1200.00
23	Transport charges			300.00
24	TOTAL COST			5636.00
25	CONTIGENCY(5% OF TOTAL COST)			282.00

26	Total Bill			5918.00
27	2 NOs of earthing set to be installed			7000.00

2. A small workshop of size 10M×6M×4M high is under construction. It is required to be provided with the following electrical power connection for motors. The electrical connection to motor are to be taken along the wall.

1. One 5 HP 3 phase motor for Lathe
2. One 3 HP 3 phase motor for a small lathe.
3. One 2 HP 3 phase Induction Motor for manufacturing machine.
4. One drilling machine driven by 1 phase 1 HP motor.
5. One grinding machine driven by 0.5 HP 1 phase motor.

Draw the installation plan, SLD and wiring diagram and make Bill of material.

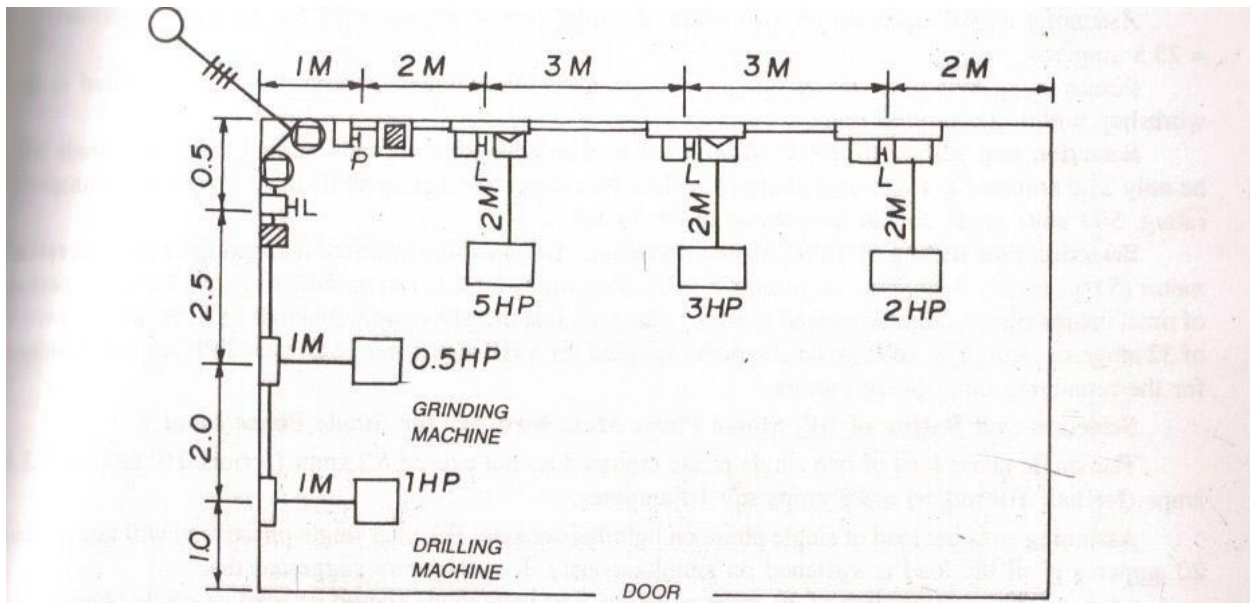

Installation Plan

### Assumption

1. Height of main board, switch board, control switch from floor-1.5m
2. Height of HR from floor level = 2.5m
3. Cost of motor and starter is not be included in the estimate.
4. Height of all 3 ph and 1 ph motor except drilling m/c is 0.5m above floor
5. Height of drilling m/c from floor is 1.5mt
6. Two earth wire required with 15mm dia GI pipe installed for earthing of the motor.

### Calculation of Load

Assuming Efficiency of 3 ph motor 0.75 and p.f 0.8

$$\text{For 5 HP motor} = \frac{5 \times 735.5}{(\sqrt{3} \times 400 \times 0.75 \times 0.85)} = 8A$$

$$\text{For 3 HP motor} = \frac{3 \times 735.5}{(\sqrt{3} \times 400 \times 0.75 \times 0.85)} = 4.5A$$

$$\text{For 2 HP motor} = \frac{2 \times 735.5}{(\sqrt{3} \times 400 \times 0.75 \times 0.85)} = 3.2A$$

$$\text{The total current in A} = 8+4.5+3.2= 15.7A$$

$$\text{Taking 50\% overload on all motor} = 15.7+7.8= 23.5A$$

### Selection and rating of TPIC MS:

As total load current after taking overload is 23.5A, It is suggested that 45A, TPIC,500V grade MS is to be selected.

### Selection And Rating Of TPIC Motor Switch

As maximum load of 5 HP motor is 8 A and after overload it is 12A , So It is suggested that a TPIC motor switch of 32A rating, 500v grade should be selected for 5 HP motor and 16A TPIC motor switch for remaining 3 phase motor.

### Selection and rating of DP, 1 Phase MS for 1 phase Load.

Assuming Efficiency of 1 ph motor 0.7 and p.f 0.8

For 1HP motor =  $1 \times 735.5 / (230 \times 0.7 \times 0.80) = 5.71A$

For 1/2 HP motor =  $0.5 \times 735.5 / (230 \times 0.70 \times 0.8) = 2.85A$

Total line current =  $5.71 + 2.85 = 8.56A$

Taking 50% overload =  $8.56 \times 0.5 = 4.28A$

Total load current =  $8.56 + 4.28 = 12.84A$

And also taking same load current for light, fan and socket

So, total current is 25A, Hence, It Is Suggested That 32A, 250V grade DPIC MS is to be selected.

### Selection and rating of wire for main board, 5HP AND 3HP motor

**For Main Board :** As total load current after taking overload is 23.5A, It is suggested that 16mm<sup>2</sup>,7/1.70mm dia PVC insulated single core Aluminum conductor is to be selected.

**For 5HP, 3ph motor :** It is suggested that 6mm<sup>2</sup>,1/2.80mm dia,400v grade PVC insulated single core Aluminum conductor is to be selected.

**For 3HP, 3 ph motor :** It is suggested that 4mm<sup>2</sup>,1/2.24mm dia,400v grade PVC insulated single core Aluminum conductor is to be selected.

### Selection and rating of wire for main 1 phase motor

It is suggested that 2.5mm<sup>2</sup>,1/1.80mm dia,250v grade PVC insulated single core copper conductor is to be selected

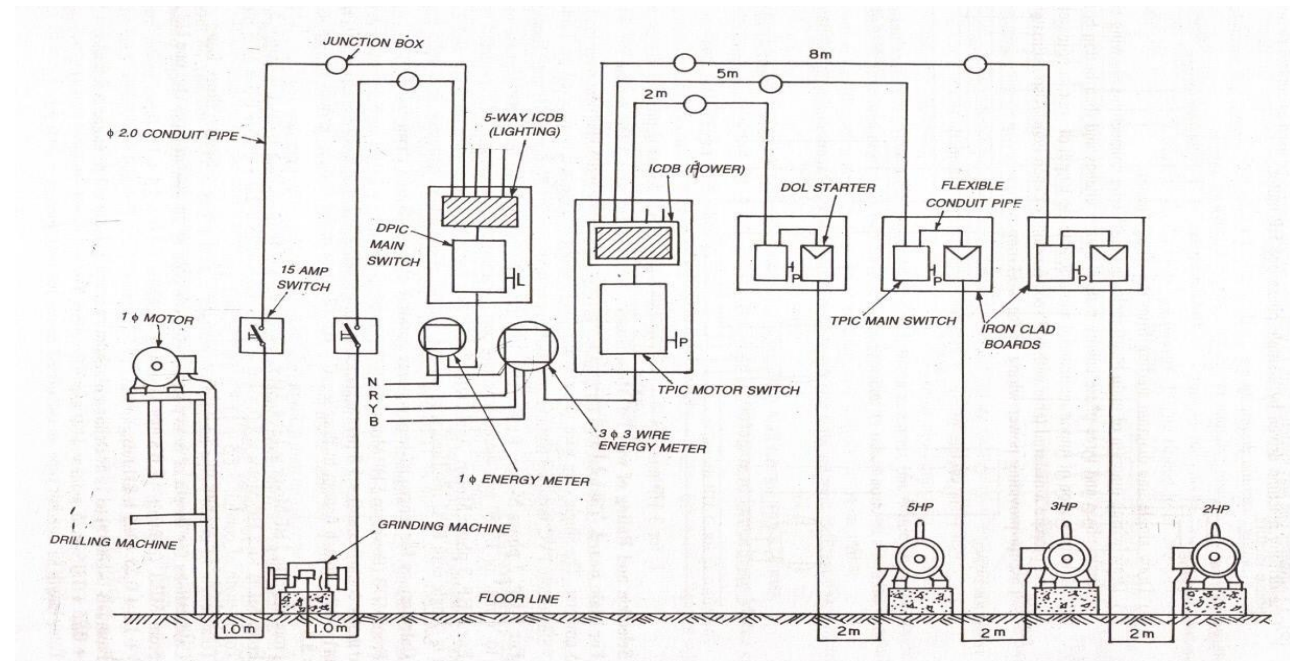

SINGLE LINE DIAGRAM

**Calculation for the length of heavy gauge conduit pipe,25mm dia:**

**From MDB to 5HP motor**

DB to HR+ along HR+ HR to Motor control board+ motor starter to floor+ depth of trench(both side)+ along the trench+ plinth height

$$1\text{m}+2\text{m}+1\text{m}+1.5\text{m}+0.25\text{m}+0.25\text{m}+2\text{m}+0.5\text{m}=8.5\text{m}$$

**From MDB to 3HP motor**

DB to HR+ along HR+ HR to Motor control board+ motor starter to floor+ depth of trench(both side)+ along the trench+ plinth height

$$1\text{m}+5\text{m}+1\text{m}+1.5\text{m}+0.25\text{m}+0.25\text{m}+2\text{m}+0.5\text{m}=11.5\text{m}$$

**From MDB to 2HP motor**

DB to HR+ along HR+ HR to Motor control board+ motor starter to floor+ depth of trench(both side)+ along the trench+ plinth height

$$1\text{m}+8\text{m}+1\text{m}+1.5\text{m}+0.25\text{m}+0.25\text{m}+2\text{m}+0.5\text{m}=14.5\text{m}$$

$$\text{Taking } 10\% \text{ wastage}=(8.5+11.5+14.5)\times 0.1=3.45\text{m}$$

$$\text{Total length of pipe required}=34.5+3.45=38\text{m}$$

**Calculation for the length of heavy gauge conduit pipe,20mm dia for 1 phase motor:**

**From MDB to 0.5HP Grinding machine**

DB to HR+ along HR+ HR to Motor control board+ motor starter to floor+ depth of trench(both side)+ along the trench+ plinth height

$$1\text{m}+2.5\text{m}+1\text{m}+1.5\text{m}+0.25\text{m}+0.25\text{m}+1\text{m}+0.5\text{m}=8\text{m}$$

**From MDB to 1 HP Drilling machine**

DB to HR+ along HR+ HR to Motor control board+ motor starter to floor+ depth of trench(both side)+ along the trench+ plinth height(1.5m from floor level)

$$1\text{m}+4.5\text{m}+1\text{m}+1.5\text{m}+0.25\text{m}+0.25\text{m}+1\text{m}+1.5\text{m}=11\text{m}$$

**Total length of conduit required for both single phase motor**

$$\text{Taking } 10\% \text{ wastage}=(8+11)\times 0.1=1.9\text{m}$$

$$\text{Total length of pipe required}=19+1.9=21\text{m}$$

**Calculation for Length of Wire of 6mm<sup>2</sup>,1/2.80mm dia for 5HP Motor:**

**No. of wire**× length of conduit without wastage(Rigid and flexible)

$$3\times(8.5) = 25.5\text{m}$$

$$\text{Taking } 10\% \text{ wastage}= 25.5\times 0.1=2.55\text{m}$$

$$\text{Total wire required} = 25.5+2.55 = 27\text{m}$$

**Calculation for Length of Wire of 4mm<sup>2</sup>,1/2.24mm dia for 3HP and 2HP Motor:**

**No. of wire**× length of conduit without wastage(Rigid and flexible)

$$3\times(11.5+14.5) = 78\text{m}$$

$$\text{Taking } 10\% \text{ wastage}= 78\times 0.1=7.8\text{m}$$

$$\text{Total wire required} = 78+7.8 = 86\text{m}$$

**Calculation for Length of Wire of 2.5mm<sup>2</sup>,1/1.80mm dia for for both 1 phase Motor:**

**No. of wire**× length of conduit without wastage(Rigid and flexible)

$$4\times(19) = 76\text{m}$$

$$\text{Taking } 10\% \text{ wastage}= 76\times 0.1=7.6\text{m}$$

$$\text{Total wire required} = 76+7.6= 84\text{m}$$

**Calculation for the length of heavy gauge conduit pipe,15mm dia for earth wire for 3PH motor only:**

From motor control board to 3 ph motor=  $(1.5+0.25+2+0.25+0.5)2=$

$$4.5\text{m}\times 2=9\text{m}$$

Same length of pipe for each 3 ph motor=  $3\times 9= 27\text{m}$

$$\text{Taking } 10\% \text{ wastage}=27\text{m}\times 0.1=2.7\text{m}$$

$$\text{Total length of pipe required}=27+2.7=30\text{m}$$

**Calculation for the length of Flexible conduit pipe,25mm dia:**

From EM to main board = 1m

From MS to Starter = 0.5m

From starter to Conduit mouth =0.25m

From motor foundation to motor terminal box = 0.25m

Total conduit required =2m

Taking 10% wastage=  $2 \times 0.1 = 0.2\text{m}$ 

Total conduit required =2m+0.2 = 2.5M

**Calculation for Length of 8SWG, GI earth wire for 3 ph motor**Total Length of earth Wire= Total Length of conduit pipe(25mm + 20mm) $\times 2 + 10\%$  wastage  
(34.5m+19m) $\times 2 = 107\text{m}$ Taking 10% wastage=  $107 \times 0.1 = 10.7\text{m}$ 

Total Length of earth Wire=107+10.7= 118m

**BILL OF MATERIAL REQUIRED**

SL NO	SPECIFICATION OF MATERIAL	QUANTITY	RATE	AMOUNT
1	TPIC, MS,45A,500v with built HRC fuse	1 no	900/each	900.00
	TPIC, MS,32A,500v with built fuse	1 no	750/each	750.00
	TPIC, MS,16A,500v with built fuse	2 no	600/each	1200.00
2	ICDB(POWER) 45A,500V for 3 motor with busbar	1 no	500/each	500.00
3	DPIC MS,32A,250V,1 PH	1 No	500/each	500.00
4	ICDB(Lighting), 6way with neutral link,32A,250V	1 no	500/each	500.00
5	15A, one way switch and socket for 1 ph motor	2 set	200/set	400.00
6	Heavy gauge conduit pipe,25mm dia for 3 ph motor	38mt	40/mt	1520.00
7	Conduit Bend	10 no	10/each	100.00
8	Conduit saddle	30 no	50/doz	150.00
9	Heavy gauge conduit pipe,20mm dia for 1 ph motor	21mt	40/mt	840.00
10	Conduit Bend	8 no	10 /each	80.00
11	Conduit saddle	15 no	5/each	75.00
12	Conduit socket 15mm dia	4 no	20/each	80.00
13	Flexible conduit 25mm dia	2.5m	20/mt	50.00
14	Flexible conduit coupler to join rigid and flexible conduit	2 no	15/each	30.00
15	Flexible conduit attachment with lock nuts to attach flexible conduit with MS, STARTER, motor	6 no	10/each	60.00
16	PVC insulated aluminum conductor, single core. 660v grade 16mm <sup>2</sup> , 7/1.70 mm dia for main board	5mt	20/mt	100.00
17	PVC insulated aluminum conductor, single core. 660v grade 6mm <sup>2</sup> , 1/2.24 mm dia for 5 HP motor	120mt	10/mt	1200.00
18	PVC insulated aluminum conductor, single core. 660v grade 6mm <sup>2</sup> , 1/2.24 mm dia for 3hp & 2 HP motor	90mt	10/mt	900.00
19	PVC insulated aluminum conductor, single core. 660v grade 6mm <sup>2</sup> , 1/2.24 mm dia for wiring of MB for 1 phase	2mt	10/mt	20.00
20	PVC insulated aluminum conductor, single core. 660v grade 2.5mm <sup>2</sup> , 1/1.80 mm dia for wiring of 1 phase motor	86mt	20/mt	1720.00

21	8SWG, GI earth wire	118mt	5/mt	590.00
22	Iron clad board of size for TPIC MS and ICDB Power -45cm×60cm	1 no	300/each	300.00
23	Iron clad board of size for 1ph MS -30cm×45cm	1 no	300/each	300.00
24	Iron clad board of size for motor switch & starter -30cm×30cm	3 no	250/each	750.00
25	Earthing Thimble16A with nut and bolt	30 no	5/each	150.00
26	Teak wood guttis for fixing conduit saddle with wall	30 no	2/each	60.00
27	Wood screws 25mm	30 no	50/100	15.00
28	Caution plate(440v)	1 no	100/each	100.00
29	Shock treatment chart	1 no	200/each	200.00
30	Civil work			1500.00
31	Labour charges for 4 labor		350/each	1400.00
32	Labour charges for wiring(2skilled labour and one helper) for two days(750+250)2			2000.00
33	Transport charges			700.00
34	TOTAL COST			19180.00
35	CONTINGENCY(5% OF TOTAL COST)			959.00
36	Total Bill			20139.00
37	2 Nos of earthing set to be installed			7000.00

### STAY CONNECTION AND EARTHING

1. A pole for overhead high tension on 11 KV 3 phase, 50 HZ line is required to be earthed and stay provided. Make neat sketch of the pole, stay arrangement and earthing. Prepare Bill of material for stay and earthing separately.

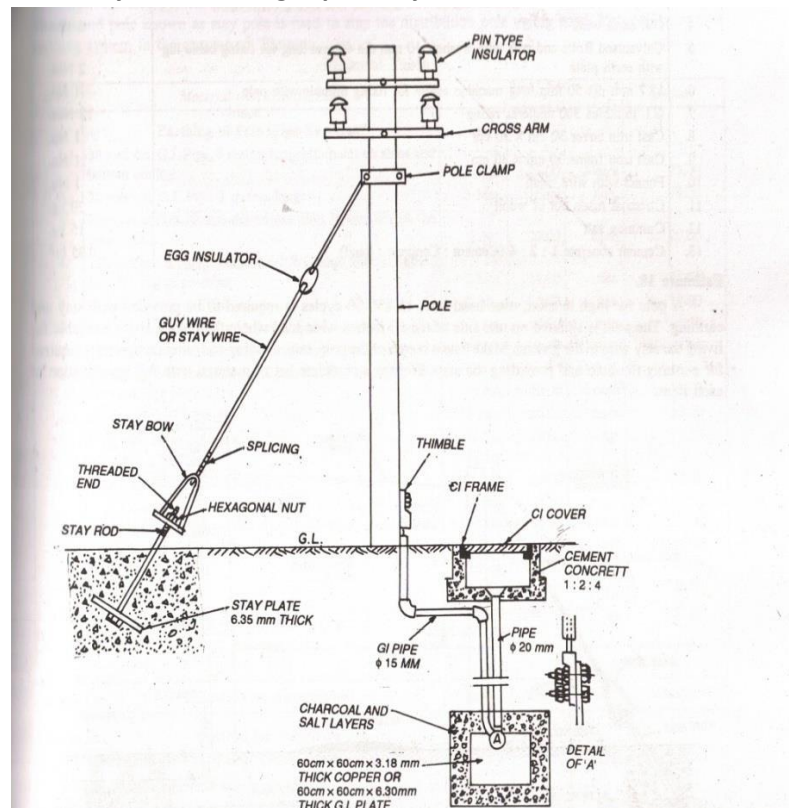

### BILL OF MATERIAL FOR STAY CONNECTION

SL NO	Specification of material	QTY
1	Galvanized steel stay rod, 1.8m long, 16mm dia with hexagonal head and thread	1 no
2	Mild steel anchor plate or stay plate(30cm×30cm×6.35mm thick)	1 no
3	Stay wire , 7/8 SWG, GI, 8 mt long	8 mt
4	Stay clamp or pole clamp with nut and bolt	1 no
5	Stay bow with 12.7mm dia Mild steel	1 no
6	Stay insulator or Egg Insulator	1 no
7	MS Thimble	1 no
8	Concreting of Stay with RCC(1:2:4)	As per required

### BILL OF MATERIAL FOR PLATE EARTHING

SL NO	Specification of material	QTY
1	GI OR Copper earth plate GI: 60cm×60cm×6.35mm thick Copper : 60cm×60cm×3.18 mm thick	1 no
2	GI pipe for earth wire, 15mm dia	5mt
3	GI bend, 15mm dia	2 no
4	GI PIPE 20mm dia for watering	4mt
5	GI earth wire, 6 swg	6mt
6	Galvanized Bolt and nuts with washer 10mm dia for fixing cable lug	2 no
7	12.7mm dia 50mm long screw for fixing Thimble with pole	2 no
8	GI Thimble, 300A	1 no
9	Cast iron cover( 30cm×30cm)	1 no
10	Cast Iron Frame( 30cm×30cm)	1 no
11	Funnel with wire mesh	1 no
12	Charcoal	30kg
13	Common salt	30kg
14	Concrete with RCC(1:2:4)	As per required

2. Prepare a bill of material of a Pipe earthing with neat sketch.

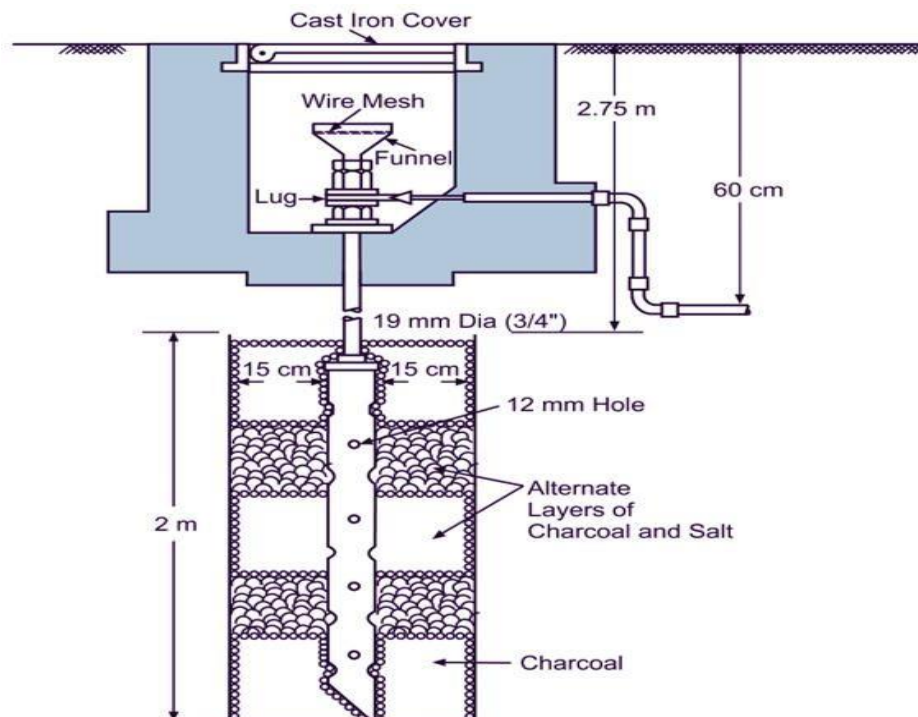

### BILL OF MATERIAL FOR PIPE EARTHING

SL NO	Specification of material	QTY
1	38mm dia GI PIPE WITH HOLE	3mt
2	20mm dia GI pipe 15mm dia GI bend	3mt 1 no
3	Reducer socket 20mm dia on one side and 38mm dia on other side	1 no
4	15mm dia GI pipe to enclose 6swg earth wire	2mt
5	GI earth wire, 6 swg	2mt
6	Galvanized Bolt and nuts with washer 20mm dia for fixing cable lug	2 no
7	12.5mm dia 50mm long screw for fixing Thimble with pole	2 no
8	GI Thimble, 300A	1 no
9	Cast iron cover( 30cm×30cm)	1 no
10	Cast Iron Frame( 30cm×30cm)	1 no
11	Funnel with wire mesh 20mm dia pipe	1 no
12	Charcoal	30kg
13	Common salt	30kg
14	Concrete with RCC(1:2:4)	As per required

### OVERHEAD SERVICE CONNECTION

1.A newly constructed single storeyed building is to be provided with single phase 230v 50Hz having a load of 5 KW (light, fan, socket). The supply is to be given from overhead line 20m away from the building. Prepare a list of material for giving service connection.

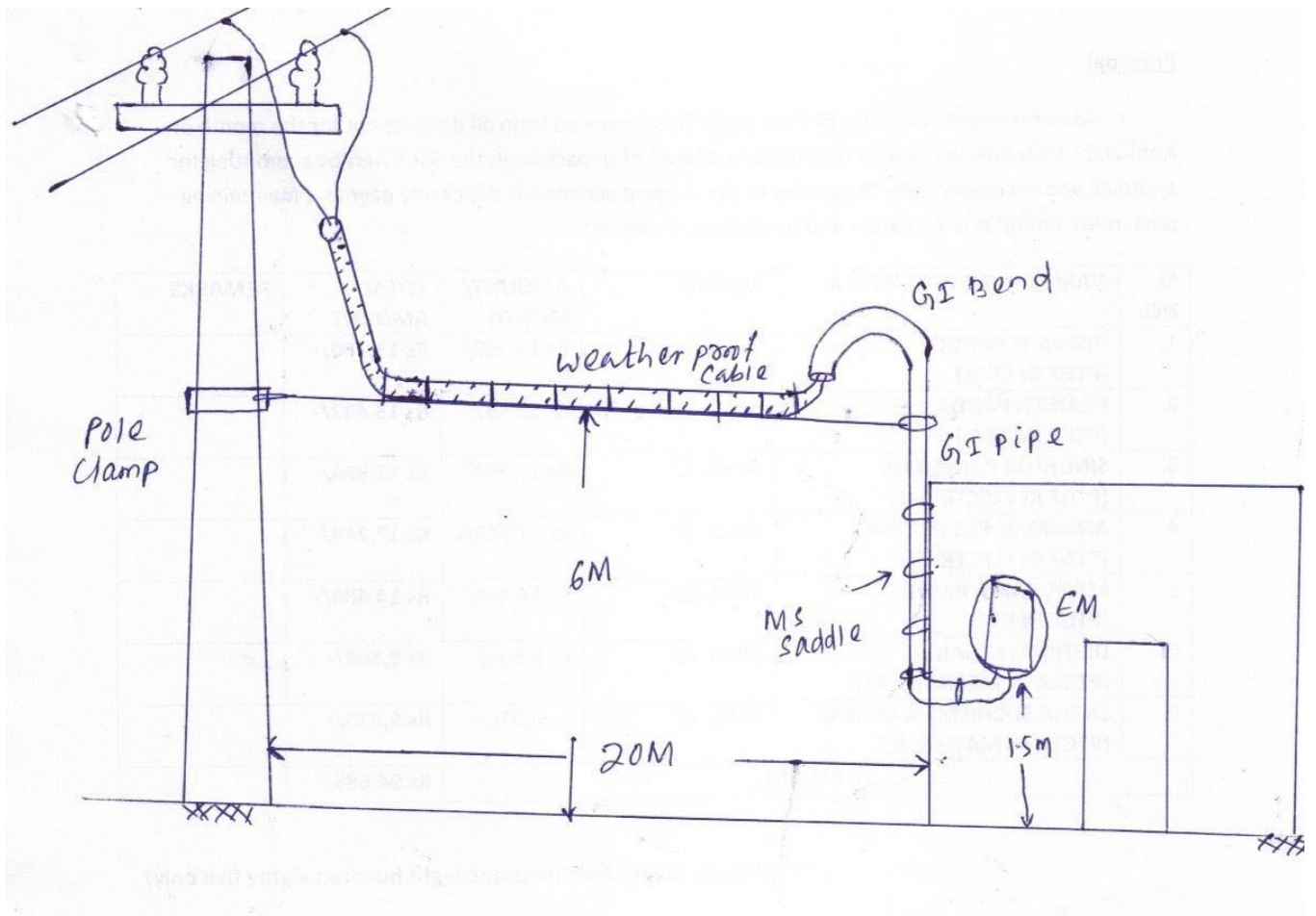



### **ASSUMPTION**

1. Height of ground floor-3.5mts
2. Service connection received at a height of 6 mts from the floor
3. Height of meter board from floor-1.5mt

### **LOAD CALCULATION**

Total connected load-5KW

Total load current- $5000/230= 21.7A$

Taking Diversity Factor (60%)= Total connected load $\times 60\%= 21.7\times 0.6=13A$

### **Selection of size and rating of weather proof cable**

It is suggested that 32A, 10mm<sup>2</sup>,1/3.55mm, dia PVC insulated twin core weather proof cable is to be selected

It is suggested that 8 SWG G.I Wire may be used for bare conductor .

### **CALCULATION OF LENGTH OF 50MM DIA GI PIPE**

Height of service connection received+ Length of 50mm dia GI Bend+ Length of GI Pipe inside wall-(height of EM from ground floor)

$$6+0.5+1-1.5=6m$$

### **CALCULATION OF LENGTH OF , 10MM<sup>2</sup>,1/3.55MM, DIA PVC INSULATED TWIN CORE WEATHER PROOF CABLE**

Span length+ 50mm GI pipe length+1% SAG

$$20+6+1\% \text{ Sag of total length}=26+26\times 0.01=26+0.26=26.26mt$$

Taking 10% wastage= $26.26\times 0.1=2.6$

Total length of weather proof cable required= $26.26+2.6=29mt$

### **CALCULATION OF 8 SWG GI WIRE FOR SUPPORTING WIRE**

Total Span Length+ 1% Sag+10% Wastage Of Total Length= $20+0.2+20.2\times 0.1=22.2mt$

### **BILL OF MATERIAL**

SL NO	Specification of material	QTY
1	32A, 10mm <sup>2</sup> ,1/3.55mm, dia PVC insulated twin core weather proof cable	29mt
2	50mm Dia Gi Pipe	6mt
3	8 Swg Gi Wire For Supporting Wire	22.2mt
4	50mm GI pipe bend	3 no
5	Pipe clamp one for fixing supporting wire on pipe	1 no
6	Pole clamp for fixing supporting wire on pole with nut and bolt	1 no
7	Aluminum clip 75mm long to hold cable	1 box
8	50mm GI pipe saddle	6 no
9	Iron clad meter board with nut and bolt 25cm $\times$ 30cm	1 no
10	4 nos bolt 10mm dia 50mm long with nuts for fixing EM with main board	4 no
11	Lock nuts for 50mm dia GI pipe at service board	1 no
13	Wood screw 50mm long for holding meter board	20 no
14	Wood screw 30mm long for holding saddle	20 no

2. Prepare a bill of material and estimate the cost for giving service connection to a double storeyed building having two energy meter. The supply is to be given at 230v single phase having load of 4 sub circuit and two 15A socket point on each floor. The supply is to be given from overhead line 25m away from the building. And also draw the diagram of service connection.

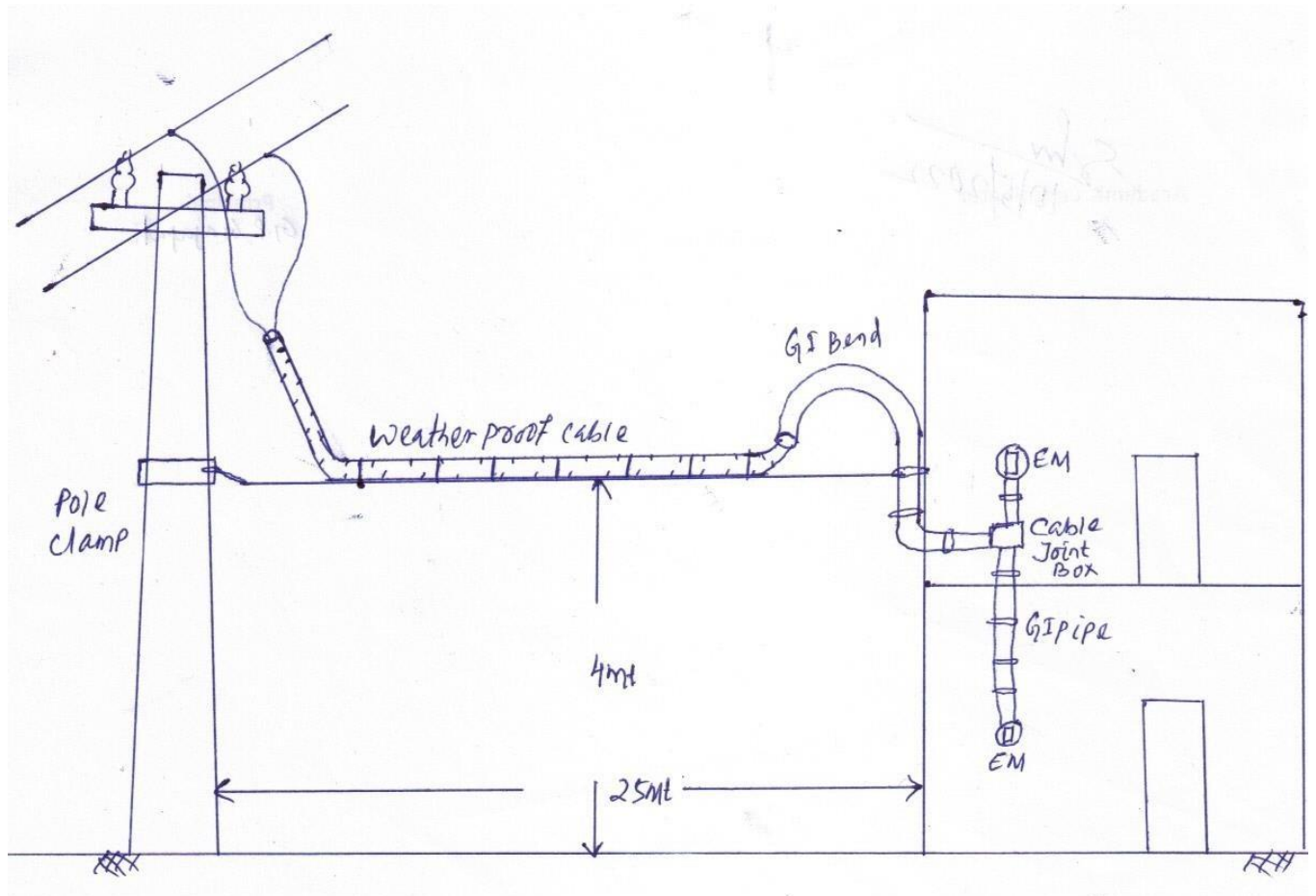

### ASSUMPTION

1. Height of ground floor-3.5mts
2. Total height of First floor from ground-7mt
2. Service connection received at a height of 4 mts from the floor
3. Height of meter board from floor-1.5mt
4. Distance from ground floor meter board to first floor meter board-3.5m

### LOAD CALULATION

Total connected load for 4 sub ckt =  $4 \times 800 = 3200w$

2 nos of 15A sub ckt =  $2 \times 1000 = 2000w$

Total connected load -5200

Total load current -  $5200/230 = 22.6A$

Total connected load for both the floor =  $22.6 + 22.6 = 45.2A$

Taking Diversity Factor (60%) = Total connected load  $\times 60\% = 45.2 \times 0.6 = 27.12A$

### Selection of size and rating of weather proof cable

It is suggested that 32A, 10mm<sup>2</sup>, 1/3.55mm, dia PVC insulated twin core weather proof cable is to be selected

It is suggested that 8 SWG G.I Wire may be used for bare conductor.

**CALCULATION OF LENGTH OF 50MM DIA GI PIPE**

Height of service connection received+ Length of 50mm dia GI Bend+ Length of GI Pipe inside wall+ Distance from ground floor meter board to first floor meter board -(height of EM from ground floor)

$$4+0.5+1+3.5-1.5=6.5\text{m}$$

**CALCULATION OF LENGTH OF , 10MM<sup>2</sup>,1/3.55MM, DIA PVC INSULATED TWIN CORE WEATHER PROOF CABLE**

Span length+ 50mm GI pipe length+1% SAG

$$25+6.5+1\% \text{ Sag of total length}=31.5+31.5\times 0.01=31.5+0.315=32\text{mt}$$

$$\text{Taking } 10\% \text{ wastage}=32\times 0.1=3.2$$

$$\text{Total length of weather proof cable required}=32+3.2=35\text{mt}$$

**CALCULATION OF 8 SWG GI WIRE FOR SUPPORTING WIRE**

$$\text{Total Span Length+ } 1\% \text{ Sag+} 10\% \text{ Wastage Of Total Length}=25+0.25+25.25\times 0.1=28\text{mt}$$

**BILL OF MATERIAL**

SL NO	Specification of material	QTY
1	32A, 10mm <sup>2</sup> ,1/3.55mm, dia PVC insulated twin core weather proof cable	35mt
2	50mm Dia Gi Pipe	6.5mt
3	8 Swg Gi Wire For Supporting Wire	28mt
4	50mm GI pipe bend	4 no
5	Pipe clamp one for fixing supporting wire on pipe	1 no
6	Pole clamp for fixing supporting wire on pole with nut and bolt	1 no
7	Aluminum clip 75mm long to hold cable	1 box
8	50mm GI pipe saddle	10no
9	Iron clad meter board with nut and bolt 25cm × 30cm	2 no
10	4 nos bolt 10mm dia 50mm long with nuts for fixing EM with main board	8 no
11	Lock nuts for 50mm dia GI pipe at service board	2no
12	3 way junction box	1 no
13	Wood screw 50mm long for holding meter board	40 no
14	Wood screw 30mm long for holding saddle	40 no

## SERVICE CONNECTION TO FACTORY

A 3 phase 4 wire underground cable service connection is to be given to a newly constructed Factory from an existing 400/230v 3 phase 4 wire 50Hz overhead line. The distance of the main board from service pole is 15 meters. The total single phase and 3 phase load in the factory is about 150A. Estimate the quantity and bill of material for giving service connection.

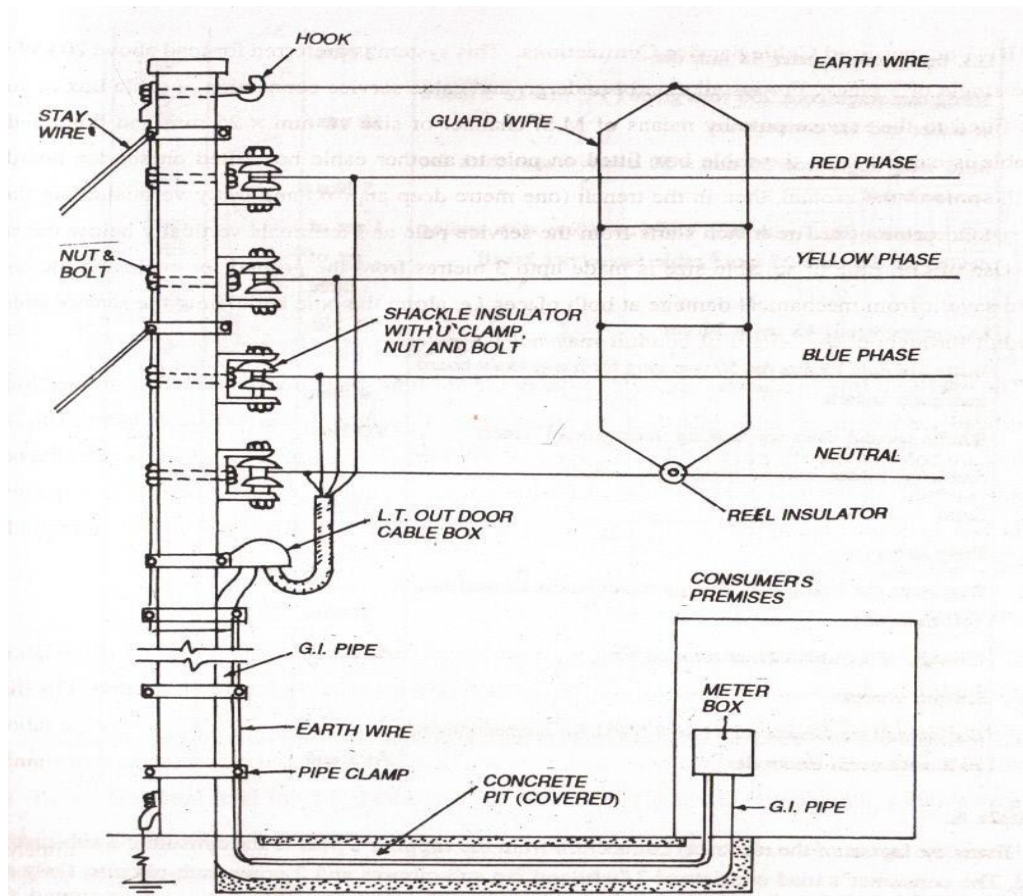

### Load Calculation

Total single phase and 3 phase load in the factory=150A

Taking Diversity factor (60%)= The actual current used at a time=  $150 \times 0.6 = 90A$

### SELECTION OF WEATHERPROOF CABLE

It is suggested that a weatherproof, mass impregnated lead covered 1100v grade, 25mm<sup>2</sup> or 7/2.24 mm aluminum cable having current capacity of 107A is to be selected.

### CALCULATION OF LENGTH OF WREATHERPROOF CABLE

Total length of cable required = Length along the pole up to ground + Length along the trench + Depth of trench + vertical run up to cable box + 10% wastage

$$6+15+1+2+ 10\% \text{ wastage} = 24+(24 \times 0.1) = 26\text{mt}$$

### CALCULATION OF LENGTH OF 50MM DIA GI PIPE

Total length of pipe required = Length along the pole up to ground + Length along the trench + Depth of trench + vertical run up to cable box + 10% wastage

$$6+15+1+2+ 10\% \text{ wastage} = 24+(24 \times 0.1) = 26\text{mt}$$

## BILL OF MATERIAL

SL NO	Specification of material	QTY
1	a weatherproof, mass impregnated lead covered 1100v grade, 25mm <sup>2</sup> or 7/2.24 mm aluminum cable having current capacity of 107A	26mt
2	50mm Dia Gi Pipe	26mt
3	6 SWG GI Wire from pole to meter box	26mt
4	50mm GI pipe bend	2 no
5	Pipe clamp one for fixing supporting wire on pipe	1 no
6	Pole clamp for cable and GI pipe	6 no
7	LT CABLE BOX FOE CABLE	1 NO
8	MS channel 76mm x38mm x6mm x0.3m long with nut and bolt	10no
9	IC Fuse unit 150A capacity(not shown in diagram)	Set of 3 fuses
10	Mild steel angle iron 50mm x50mm x6mm for service board	5 no
11	IC meter board 45cm x30cm	1no
12	Bolt and nuts 15mm dia 50mm long for fixing main board and main switch	4 no
13	Bricks required for making underground trench	300 no
14	Solder, tapes ,lugs, cement, sand	As per reqd
15	Labour charges(20% total cost)	
16	Galvanized steel earth wire 8 SWG	As per reqd

## OVERHEAD LINE INSTALLATION

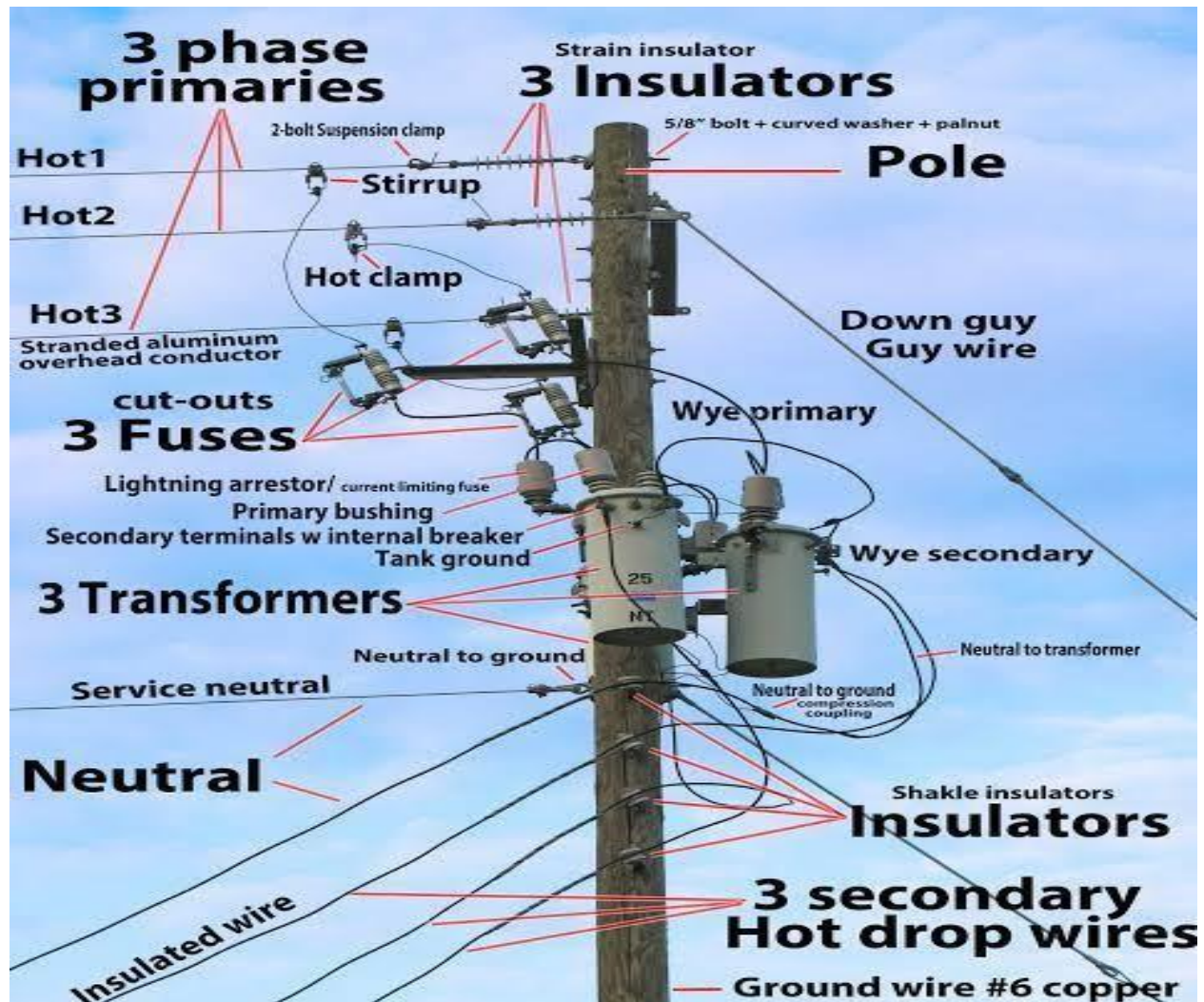

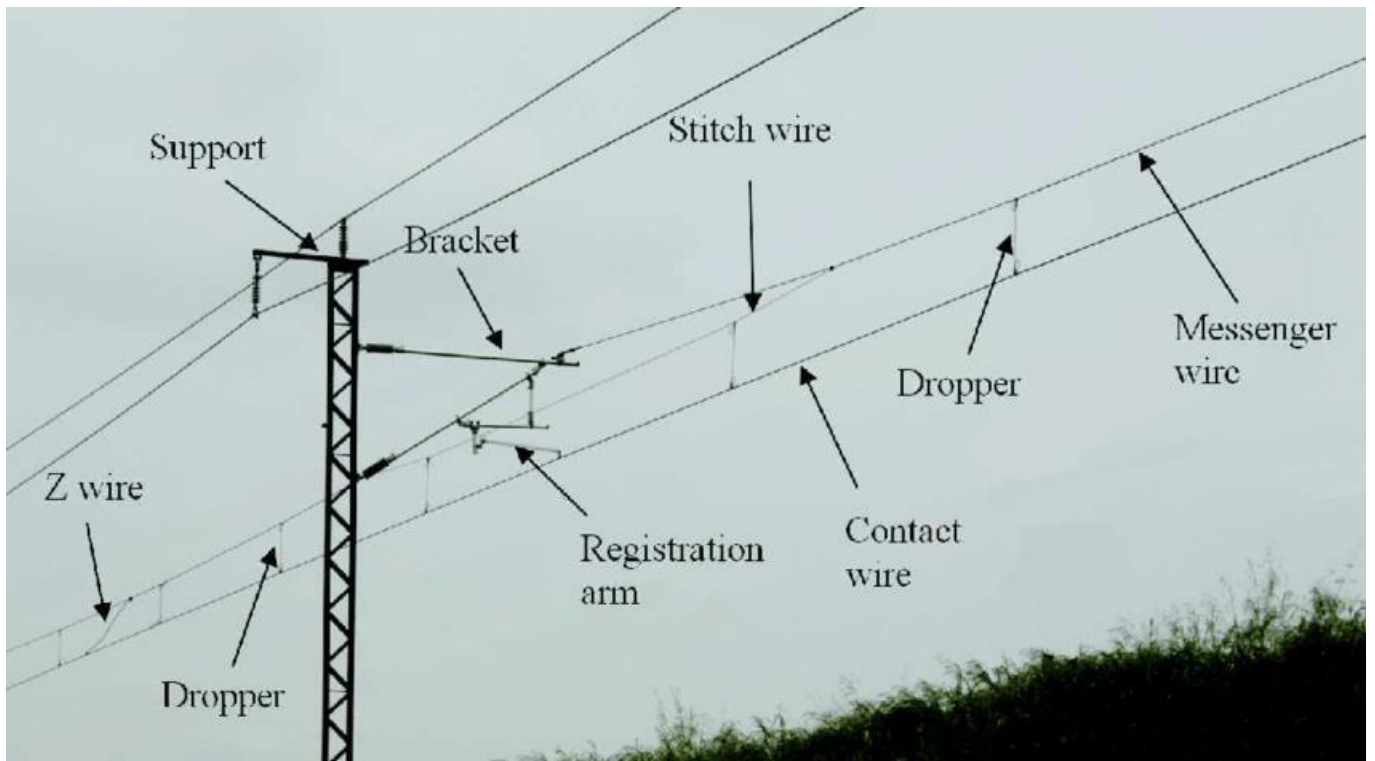

**The main components of an overhead line are enlisted, as below.**

1. Supports.

Poles or towers depending upon the working voltage and the region where these are used. The function of the line support is obviously to support the conductors so as to keep them at a suitable level above the ground.

2. Cross arms and Clamps.

These are either of wood or steel angle section and are used on pole structures to support the insulators and conductors.

3. Insulators.

Pin, strain or suspension types, as the case may be, for supporting the conductors and taking strain or suspending the conductors respectively.

4. Conductors.

Copper, aluminum or ACSR or of any other composition depending upon the current to be carried and the span of the line.

5. Guys and Stays.

Braces or cables are fastened to the pole at the termination or angle poles to resist lateral forces.

6. Lightning Arrestors.

To discharge excessive voltages built upon the line, to earth, due to lightning.

7. Fuses and Isolating Switches to isolate different parts of the overhead system.

8. Continuous Earth Wire is run on the top of the towers to protect the line against lightning discharges.

9. Vee Guards are often provided below bare overhead lines running along or across public streets to make the line safe if it should break.

10. Guard Wires are provided above or below power lines while crossing telephone or telegraph lines. The guard wires and steel structures are solidly connected to earth.

11. Phase Plates in order to distinguish the various phases.

12. Bird Guards.

A stick of ebonite with rounded top is fixed near the insulator on the cross arm to prevent flashover due to birds pecking on the conductors (on lines with pin insulators).

13. Danger plate.

It is provided on each pole, as a warning measure indicating the working voltage of the line and the word "danger". It is provided at a height of 2.5 m from the ground.

14. Barbed Wire.

Barbed wire is wrapped on a pole at a height of about 2.5 m from the ground for at least 1 meter. This prevents climbing by unauthorized persons.

15. Tee off : The tee off from a line should be taken only from a pole & not in the middle of the span.

16. Miscellaneous Items such as vibration dampers, top hampers, beads for jumpers etc.

## **Various Types of Conductor Material Used for Overhead Lines:**

### **Copper:**

Copper is the most commonly used material for the construction of overhead line conductors. It easily conducts electrical current and is easily available. There are three kinds of copper wire, hard-drawn copper, medium hard-drawn copper, and soft-drawn copper. Among these, the hard-drawn copper is mostly used for the construction of conductors because it is less elastic in nature and has high mechanical strength.

The current density of copper is high and hence requires less cross-sectional area than others. Other advantages include durability, higher scrap value, and homogeneity. Owing to its advantages, all small conduction and heavy power cables are made up of copper. However, it is not preferred for overhead transmission and distribution lines due to its high capital cost.

### **Aluminum:**

Aluminum is the most commonly used material for transmission and distribution lines in the power system. It is cheaper and lighter in weight than copper. Owing to its lightweight, the tower structures used need not be so strong as that of copper. It is mostly used for carrying heavy currents.

For such applications, a special type of configuration is used which is called ACSR conductors (Aluminium Conductor Steel Reinforced). In this configuration, small strands of aluminum, are twisted around a steel core. This not only increases the current carrying capacity but also increases flexibility and mechanical strength.

The main drawbacks of aluminum are, it has lesser conductivity (60% of that of copper), lesser tensile strength (45% of copper), low melting point, and difficulty to make joints. Even though aluminum suffers from drawbacks, it is universally used for transmission and distribution conductors.

### **Galvanized Steel :**

Galvanized steel is the cheapest material of all and hence is used in areas where the economy is the primary factor. However, it suffers from some drawbacks like low conductivity, high resistance and hence it is used only for small power and short-distance applications. It is also used for applications that require longer spans.

### **Cadmium Copper :**

Cadmium copper is used for applications that require long spans and a small cross-sectional area. Cadmium is used along with copper in order to increase tensile strength. Owing to its higher cost, it is used for some specific applications.

### **Copper Weld Steel :**

Copper weld steel conductors are nothing but steel wire with a copper coating. This configuration is used in order to have advantages of both copper and steel i.e., higher conductivity, greater strength, and less cost. It is basically used for rural lines, guy wires, and overhead ground wires. The main advantage of this conductor is that the conductivity can be increased to any percentage by providing the necessary thickness of the copper coating.

The conductors used for overhead Transmission Line are usually stranded in order to increase the flexibility and to cope up with skin effect. In stranded conductor, there is one central wire around which layers of wires containing 6,12, 18, 24,.. wires are there.

Thus if there are n layers in a Stranded Conductor, then total number of individual wire in that conductor,

$$= 1 + 6 + 12 + 18 + 24 + \dots$$

$$= 1 + 6[1 + 2 + 3 + 4 + 5 + \dots]$$

$$= 1 + 6[(n+1)n / 2] \dots \dots [\text{Sum of } n \text{ natural number} = n(n+1) / 2]$$

$$= 1 + 3n(n+1)$$

Now, we will discuss the properties of each conductor material and thereby will judge their usability in overhead Transmission Line.

Generally, all types of conductors are in stranded form in order to increase the flexibility. Solid wires, except for very small cross sectional area, are very difficult to handle and, also, they tend to crystallize at the point of support because of swinging in winds.

1. AAC : All Aluminum Conductor

2. AAAC : All Aluminum Alloy Conductor
3. ACSR : Aluminum Conductor, Steel Reinforced
4. ACAR : Aluminum Conductor, Alloy Reinforced

### **AAC : All Aluminum Conductor**

This type is sometimes also referred as **ASC (Aluminum Stranded Conductor)**. It is made up of strands of EC grade or Electrical Conductor grade aluminum. AAC conductor has conductivity about 61% [IACS](#) (International Annealed Copper Standard). Despite having a good conductivity, because of its relatively poor strength, AAC has limited use in transmission and rural distribution lines. However, AAC can be seen in urban areas for distribution where spans are usually short but higher conductivity is required.

### **AAAC : All Aluminum Alloy Conductor**

These conductors are made from aluminum alloy 6201 which is a high strength Aluminum-Magnesium-Silicon alloy. This alloy conductor offers good electrical conductivity (about 52.5% IACS) with better mechanical strength. Because of AAAC's lighter weight as compared to ACSR of equal strength and current capacity, AAAC may be used for distribution purposes. However, it is not usually preferred for transmission. Also, AAAC conductors can be employed in coastal areas because of their excellent corrosion resistance.

### **ACSR : Aluminum Conductor, Steel Reinforced**

ACSR consists of a solid or stranded steel core with one or more layers of high purity aluminum (aluminum 1350) wires wrapped in spiral. The core wires may be zinc coated (galvanized) steel or aluminum coated (aluminized) steel. Galvanization or aluminization coatings are thin and are applied to protect the steel from corrosion. The central steel core provides additional mechanical strength and, hence, sag is significantly less than all other aluminum conductors. ACSR conductors are available in a wide range of steel content - from 6% to 40%. ACSR with higher steel content is selected where higher mechanical strength is required, such as river crossing. ACSR conductors are very widely used for all transmission and distribution purposes.

### **Aluminum Conductor, Alloy Reinforced**

ACAR conductor is formed by wrapping strands of high purity aluminum (aluminum 1350) on high strength Aluminum-Magnesium-Silicon alloy (6201 aluminum alloy) core. ACAR has better electrical as well as mechanical properties than equivalent ACSR conductors. ACAR conductors may be used in overhead transmission as well as distribution lines.

### **Bundled Conductors**

Transmission at extra high voltages (say above 220 kV) poses some problems such as significant corona loss and excessive interference with nearby communication lines when only one conductor per phase is used. This is because, at EHV level, the electric field gradient at the surface of a single conductor is high enough to ionize the surrounding air which causes corona loss and interference problems. The electric field gradient can be reduced significantly by employing two or more conductors per phase in close proximity. Two or more conductors per phase are connected at intervals by spacers and are called as bundled conductors. The image at right shows two conductors in bundled form per phase. Number of conductors in a bundled conductor is greater for higher voltages.



**Table 21.1. Current rating for hard drawn solid copper conductor for overhead lines**

SWG Number of conductor	Weight in kg/km	Diameter of conductor in mm	Nominal cross-sectional area in mm <sup>2</sup>	Current Rating for Temperature rise of	
				27.8°C in amperes	55.5°C in amperes
10	73.79	3.251	8.30	37	50
9	93.43	3.658	10.51	44	60
8	115.32	4.064	12.97	52	70
7	139.53	4.470	15.70	58	81
6	166.06	4.877	18.68	68	92
5	204.4	5.385	22.77	78	107
4	242.4	5.893	26.27	91	122
3	286.1	6.401	32.18	103	139
2	343.2	7.010	38.60	117	158
1	405.4	7.620	45.60	133	181
0	472.9	8.230	53.19	150	203
00	545.4	8.839	61.36	167	226
000	623.4	9.449	70.72	184	250
0000	840.7	10.160	81.07	205	278

**Table 21.2. Current rating of hard drawn bare copper conductor**

Conductor strands	Weight kg/km	Ultimate tensile strength	Current rating for temperature rise of	
			27.8°C	55.5°C
3/1.62	131.4	622.3	52	70
3/2.64	149.1	688.7	68	88
3/3.73	298.1	1317	110	149
7/2.64	346.9	1606	124	168
7/3.45	593.3	2662	186	251
7/4.22	884.3	3863	250	338
4/4.90	1195.0	5112	314	423
19/2.94	1174.0	5194	314	423
7/5.46	1484.0	6261	370	500
19/3.33	1497.0	6609	370	500

**Table 21.3. Current Rating for A.C.S.R. Conductor for Overhead Lines. (I.S. 398 – 1961)**

Code word	No. of Aluminium wires	No. of steel wires	Diameter of wire in mm	Number and Diameter of wire in mm	Diameter of conductor in mm	Approximate weight of conductor in kg-/km	Approximate ultimate tensile strength of conductor in kg	Approximate current carrying capacity in amperes	
								At ambient temperature of 40°C	At ambient temperature of 45°C
Squirrel	6	1	2.11	6/1 × 2.11	6.33	85	771	115	107
Gopher	6	1	2.36	6/1 × 2.36	7.08	106	952	133	123
Weasel	6	1	2.59	6/1 × 3.59	7.77	128	1136	150	139
Ferret	6	1	3.00	6/1 × 3.00	9.00	171	1503	181	168
Rabbit	6	1	3.55	6/1 × 3.35	10.05	214	1860	208	193
Mink	6	1	3.66	6/1 × 3.66	10.98	255	2207	234	217
Mink	6	1	3.99	6/1 × 3.99	11.97	303	2613	261	242
Raccoon	6	1	4.09	6/1 × 4.09	12.27	318	2746	270	250
Otter	6	1	4.22	6/1 × 4.22	12.66	339	2923	281	260
Cat	6	1	4.50	6/1 × 4.50	13.50	385	3324	305	283
Dog	6	7	4.72	6/1 × 4.72	14.15	394	3299	324	300
Leopard	6	7	5.28	6/1 × 5.28	15.84	493	4137	375	348
Tiger	30	7	2.36	30/7 × 2.36	16.52	604	5758	382	354
Wolf	30	7	2.59	30/7 × 2.59	18.13	727	6880	430	398
Lynx	30	7	2.79	30/7 × 2.79	19.53	844	7950	475	440
Panther	30	7	3.00	30/7 × 3.00	21.00	976	9127	520	482
Lion	30	7	3.18	30/7 × 3.18	22.26	1097	10210	555	515
Bear	30	7	3.55	30/7 × 3.55	23.45	1229	11310	595	552
Goat	30	7	3.71	30/7 × 3.71	25.97	1492	13760	680	630
Sheep	30	7	3.99	30/7 × 2.99	27.93	1726	15910	745	690
Dear	30	7	4.27	30/7 × 4.27	29.50	1977	18230	806	747
Eik	30	7	4.50	30/7 × 4.50	31.50	2196	20240	860	796
Mouse	54	7	3.53	54/7 × 3.53	31.77	2002	16250	900	835

**Table 21.4. Current Rating for All Aluminium (stranded) Conductor (A.A.C.)**

Code word	Number and Diameter of wire in mm	Diameter of conductor in mm	Approximate weight of conductor in kg/km	Approximate ultimate tensile strength of conductor in kg	Approximate current carrying capacity in amperes	
					At ambient temperature of 40°C	At ambient temperature of 45°C
Mantis	3/3.00	6.468	58	363	116	108
Aphis	3/3.55	7.223	72	394	133	123
Weevil	3/3.66	7.894	86	521	147	136
Lady-bird	7/2.79	8.374	117	737	178	165
Ant	7/3.10	9.30	144	892	204	189
Fly	7/3.40	10.20	174	1051	229	212
Blue battle	7/3.65	10.95	201	1203	252	234
Earwig	7/3.78	11.34	215	1272	264	245
Grass hopper	7/3.91	11.73	230	1356	275	255
Clegg	7/4.17	12.51	261	1523	298	276
Wasp	7/4.39	13.17	290	1673	318	295
Catter pillar	19/3.53	10.59	511	2985	460	386
Chafer	19/3.78	18.90	586	3381	504	468
Spider	19/3.99	19.95	652	3736	540	504
Cockroach	19/4.22	21.10	730	4144	575	534
Butter fly	19/4.65	23.25	886	4947	655	608
Moth	19/5.00	25.00	1025	5695	720	660
Locust	19/5.36	26.80	1176	6516	790	734
Maybug	37/4.09	28.63	1343	7289	850	790
Scorpion	37/4.27	29.89	1464	7878	895	830

Table 21.5. Particulars of Aluminium Conductor Steel Reinforced (ACSR) Conforming to I.S. 398 - 1961

Standard Nominal Copper area mm <sup>2</sup>	Stranding no. and wire diameter in mm.				Dia. of complete conductor mm.	Calculated equivalent area of Aluminium mm <sup>2</sup>	Approx. ultimate tensile strength of conductor kg/mm <sup>2</sup>	Calculated resistance at 20°C ohms/km	Approx. wt. in kg. per km.			Standard length of con- ductor in metres	Approx. wt. of standard length kg
	Aluminium		Steel						Complete cable				
	No.	Dia.	No.	Dia.									
13	6	2.11	1	2.11	6.33	20.71	771	1.374	57.5	27.2	84.7	2,500	212
16	6	2.36	1	2.36	7.08	25.91	952	1.098	71.9	34.1	106.0	2,000	212
20	6	2.59	1	2.59	7.77	31.21	1,136	0.9116	86.6	41.1	127.7	1,650	211
25	6	3.00	1	3.00	9.00	41.87	1,503	0.6795	116.2	55.1	171.3	1,220	209
30	6	3.35	1	3.35	10.05	52.21	1,860	0.5449	144.8	68.8	213.6	1,960	419
40	6	3.66	1	3.66	10.98	62.32	2,207	0.4565	172.9	82.1	255.0	1,600	408
45	6	3.99	1	3.99	11.97	74.07	2,613	0.3841	205.5	97.5	303.0	1,350	409
48	6	4.09	1	4.09	12.27	77.85	2,746	0.3656	215.9	102.5	318.4	1,280	408
50	26	2.54	7	1.90	12.66	82.83	2,923	0.3434	229.9	109.1	339.5	1,200	407
55	30	2.36	7	2.36	13.55	94.21	3,324	0.3020	261.4	124.0	385.4	1,060	409
65	30	2.59	7	2.59	14.15	103.60	3,299	0.2745	287.6	106.4	394.0	1,110	438
80	30	2.79	7	2.79	15.84	129.70	4,137	0.2193	359.8	133.8	493.6	885	437
80	30	2.54	7	1.90	15.86	128.51	4,638	0.2214	365.1	155.8	520.9	2,020	1,053
80	30	2.36	7	2.36	16.52	128.10	5,758	0.2221	363.4	240.4	603.8	1,960	1,184
85	30	2.59	7	2.59	18.13	154.30	6,880	0.1844	437.8	289.6	727.4	1,640	1,193
110	30	2.79	7	2.79	19.53	179.00	7,950	0.1589	508.1	336.1	844.2	1,410	1,191
130	30	3.00	7	3.00	21.00	207.00	9,127	0.1375	587.4	388.6	976.0	1,225	1,196
140	30	3.18	7	3.18	22.26	232.50	10,210	0.1223	660.0	436.6	1096.6	1,090	1,196
160	30	3.35	7	3.35	23.45	258.10	11,310	0.1102	732.2	484.5	1216.7	1,975	1,187
185	30	3.71	7	3.71	25.97	316.50	13,780	0.08889	898.2	594.2	1392.4	1,555	2,314
225	30	3.99	7	3.99	27.93	366.10	15,910	0.07771	1,093	687.3	1720.3	1,335	2,305
260	30	4.27	7	4.27	29.89	419.30	18,230	0.06786	1,190	787.2	1977.2	1,165	2,304
300	30	4.50	7	4.50	31.50	465.70	20,240	0.06110	1,321.5	874.2	2195.7	1,050	2,306
325	54	3.53	7	3.53	31.77	515.70	16,250	0.05517	1,463.6	537.9	2001.5	880	1,762

1. A tube well owner wants 3 phase 4 wire connection to his 10BHP motor from an overhead double pole structure having a transformer of 25KVA, 11/0.4 KV. The double pole structure is 450m away from the tube well. Estimate the quantity of material required for erecting line and giving service connection to the tube well. And also draw the neat sketch.

**Calculation of poles**

$$\begin{aligned} \text{Total nos of pole required} &= (\text{Total span} / \text{Adjacent distance between pole}) + \text{end pole} \\ &= (450 / 80) + 1 = 7 \text{ Nos} \end{aligned}$$

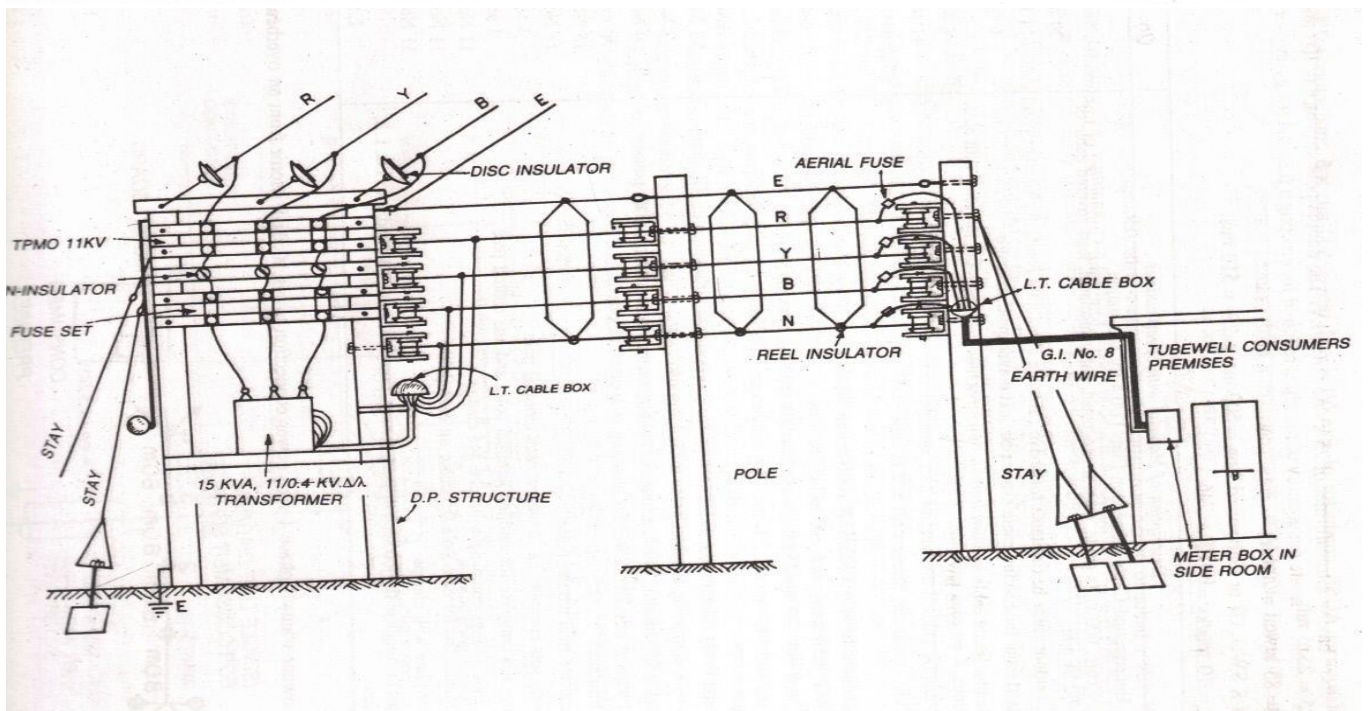
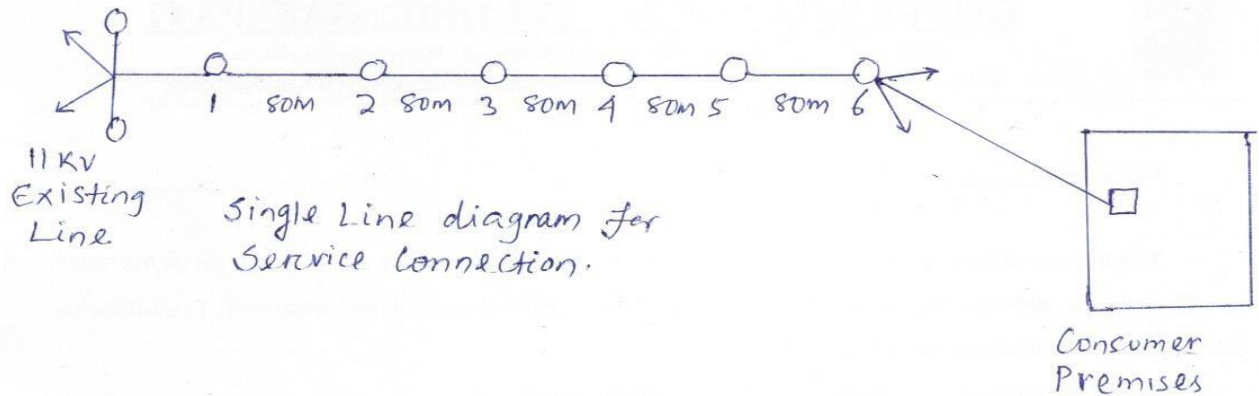

$$\text{Total load current} = (10 \times 746) / (\sqrt{3} \times 400 \times 0.8 \times 0.9) = 15A$$

$$\text{Safe load current} = 15 \times 1.5 = 22A$$

Referring ACSR conductor chart, it is suggested that 6/1×2.11mm stranded conductor may be selected for LT line.

For Neutral wire, taking 50% rating of phase wire to be taken

$$= 22.5 \times 0.5 = 11A$$

Referring ACSR conductor chart, it is suggested that 6/1×2.11mm stranded conductor may be selected for Neutral wire.

### **VOLTAGE DROP CALCULATION**

Length of Wire = 450m +1% sag =454m

Voltage drop for 454m length for full load current of 15A is

V.R = Load current × resistance/km × length of conductor

$$=(15 \times 1.374 \times 454) / 1000 = 9.35 \text{ v/ph}$$

Percentage Regulation =  $VR \cos\phi / VL = (9.35 \times 0.8 \times 100) / 400 / \sqrt{3} = 6.95\%$

Here, Regulation is 6.95% and it is just more than 5% so, it may be allowed for selection of conductor.

Total Length of Phase Wire = (450 + 1% sag +10% of wastage) × no of wire

$$= (454+45) \times 3 = 1500\text{m}$$

Total length of Neutral wire = (450 + 1% sag +10% of wastage) × no of wire

$$= 499\text{m}$$

For service connection to the motor, the LT 6mm<sup>2</sup> weatherproof aluminum cable will be used from end pole to energy meter box.

### **BILL OF MATERIAL**

<b>SL NO</b>	<b>Specification of material</b>	<b>QTY</b>
1	a weatherproof LT Aluminum conductor 660v grade, 6mm <sup>2</sup>	8mt
2	VIR, a weatherproof LT Aluminum conductor 660v grade, 6mm <sup>2</sup> for loose connection from Overhead line conductor to cable box on both side	8mt
3	Concrete pole, 9 mt long	7 nos
4	ACSR, SQUIRREL 6/1×2.11mm stranded conductor Including Neutral conductor	2000mt
5	8 SWG Earth conductor	499m
6	14 SWG GI BINDING WIRE	3 KG
7	LT Shackle type insulator with D strap 4 on each pole	28 NO
8	Nut and bolt 15mm dia 200 mm long to fix D strap with pole	28 no
9	Nut and bolt 15mm dia 125 mm long to fix Shackle Insulator with D strap	28 no
10	EYE bolt 15mm dia 200mm long for supporting earth wire	4 no
11	Earth wire pole clamp one on each end pole	2no
12	Stay wire set complete	4set
13	Earthing set-plate earthing	1 set
14	LT outdoor cable box with clamp	2 no
15	Cable clamp for holding cable with pole	4 no
16	Pole clamp for fixing 8 SWG earth wire for service connection	1 no
17	GI hook	1 no
18	Cable saddle with screw	5 no
19	Areal fuse 30A	3 No
20	KIT KAT 30A , 660v	3 no
21	KIT KAT 30A , 250v for single phase	2 no
22	3 ph 3 wire KWH energy meter 25A	1 NO
23	1 ph KWH energy meter 25A	1 NO
24	Pole foundation	As per reqd
25	Danger plate	1 no

2. Estimate the quantity of material required for the construction of 1 km overhead line. The line is tapped from the existing 11 KV line to feed a particular locality. The particulars of the important material to be used for the line to be erected are as follows :

- (a) Size of conductor: ACSR 6/1×2.59
- (b) Tubular pole or support of 11m long
- (c) Size of earth wire : 8 SWG GS
- (d) Average span : 100m
- (e) No of earthing set to be installed : 3 Nos

Calculation of poles

$$\begin{aligned} \text{Total nos of pole required} &= (\text{Total span/Adjacent distance between pole}) + \text{end pole} \\ &= (1000/100) + 1 = 11 \text{ Nos} \end{aligned}$$

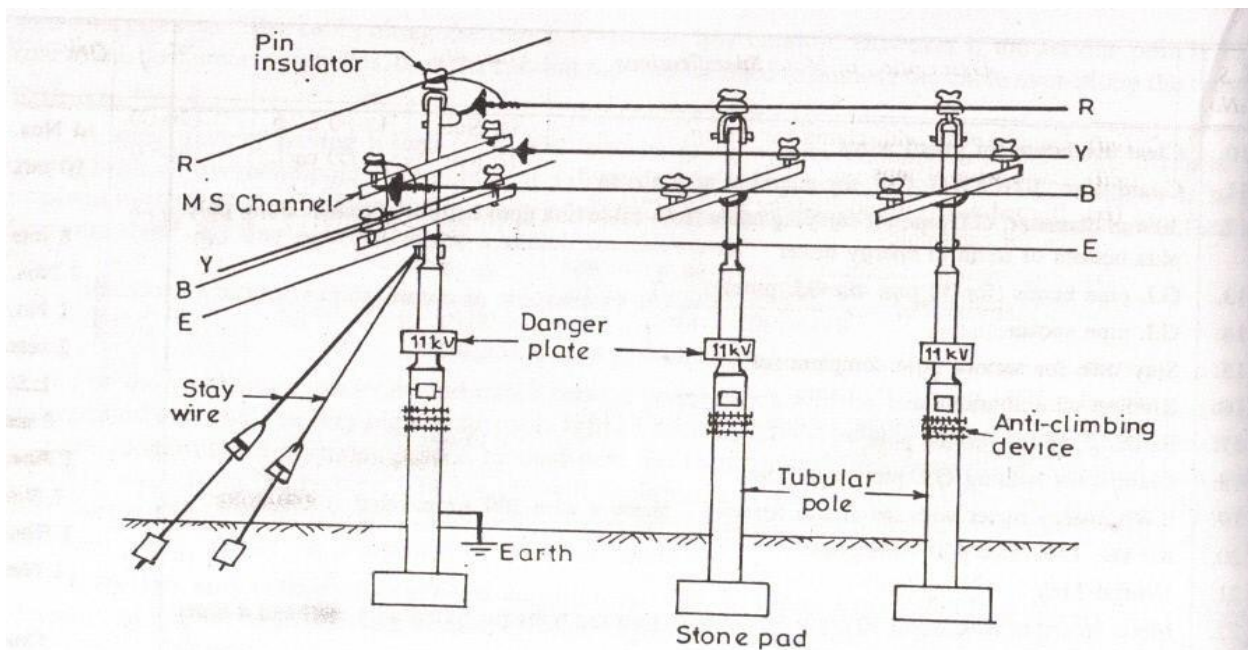
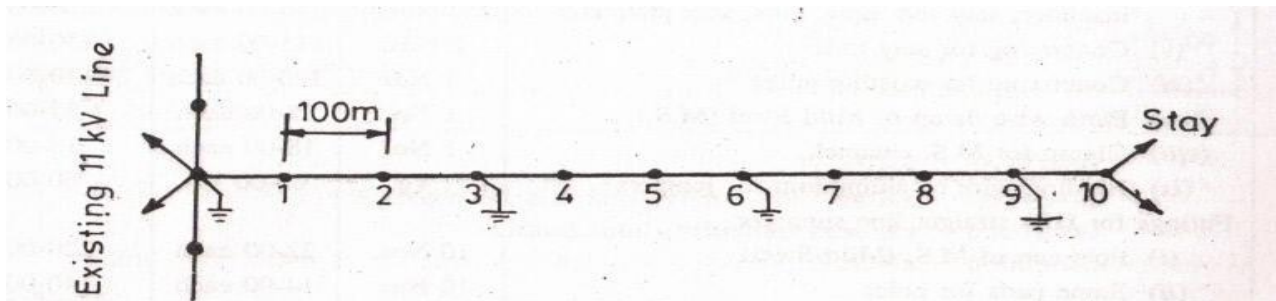

In the above question, No need to calculate Load current and voltage drop and Voltage Regulation because Size of conductor is already given.

$$\begin{aligned} \text{Total Length of Phase Wire} &= (1000 + 1\% \text{ sag} + 10\% \text{ of wastage}) \times \text{no of wire} \\ &= (1010 + 100) \times 3 = 3330 \text{m} \end{aligned}$$

$$\begin{aligned} \text{Total length of Earth wire} &= (1000 + 1\% \text{ sag} + 10\% \text{ of wastage}) \times \text{no of wire} \\ &= 1110 \text{m} \end{aligned}$$

**BILL OF MATERIAL**

SL NO	Specification of material	QTY
1	Tubular Line support	11 no
2	Material required for connection with existing Line	
a.	MS Channel for x arm(10cm×5cm×1.5m)	1 no
b	HT 11KV Disc insulator with fitting	3 no
C	HT 11KV Pin type insulator with fitting for jumpers	3 no
d	Stay set	2 no
E	Concreting for stay rod	2 no
F	Concreting for existing pole	1 no
G	MS Earth wire clamp	1 no
H	Clamp for MS Channel	1 no
I	Binding wire for jumpers	1 kg
3	FITTINGS OF HT STRAIGHT LINE SUPPORT	4set
A	Pole cap of MS	11 NO
B	Stone pad for pole	11 no
C	Angle Iron cross arm 1 for each pole	11no
D	Cross arm clamp	11 no
E	11 KV Pin type insulator with fitting	33 nos
F	Number plate	11 no
G	Danger plate with clamp	11 no
H	Earth wire clamp	11 no
I	Barbed wire	10kg
J	Binding wire	6 kg
4	ACSR Conductors 6/1×2.59	3330m
5	GI Earth wire 8 SWG	1110M
6	Complete earthing set	3 no
7	Painting for poles	As per reqd
8	Transportation charges	As per reqd
9	Labour charges	As per reqd
10	Contingency chages	5% of total cost
11	Concreting for 11 poles	As per reqd

**3. Estimate the quantity of material required for the construction of 1.3 km overhead line. The line is tapped from the existing 11 KV line to feed a particular locality. Assuming That the line is passing over the main road, Telegraph line, Railway line and River. The particulars of the important material to be used for the line to be erected are as follows :**

**(a) Size of conductor: ACSR 6/1×2.36**

**(b)Type of pole : RS JOIST pole 10m and 11.5m long**

**(c) Size of earth wire : 7/16 SWG GS**

**(d) Average span : 100m**

**(e) No of earthing set to be installed : 3 Nos**

**(f) Type of earthing – Plate earthing**

**Calculation of poles**

Total nos of pole required = (Total span/Adjacent distance between pole) + end pole  
= (1300/100) +1 =14 Nos



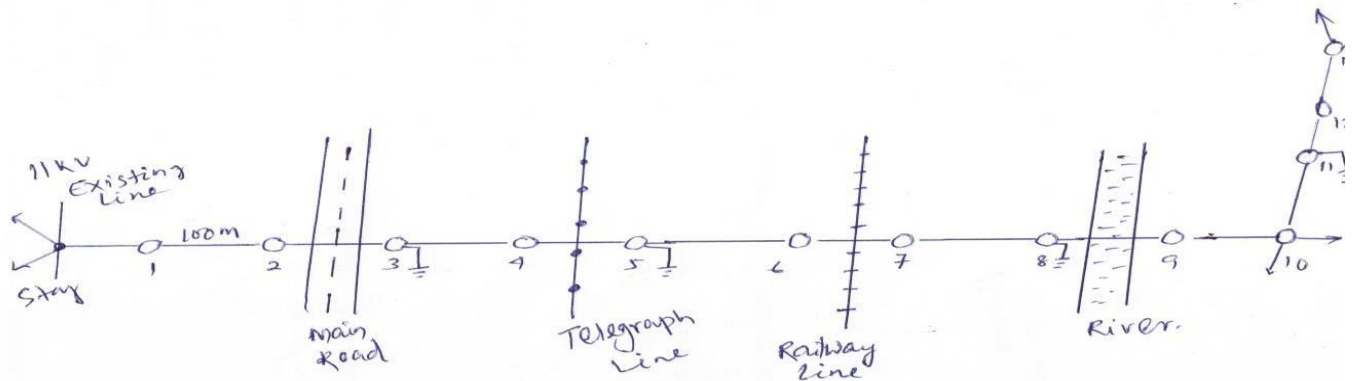

SINGLE LINE DIAGRAM

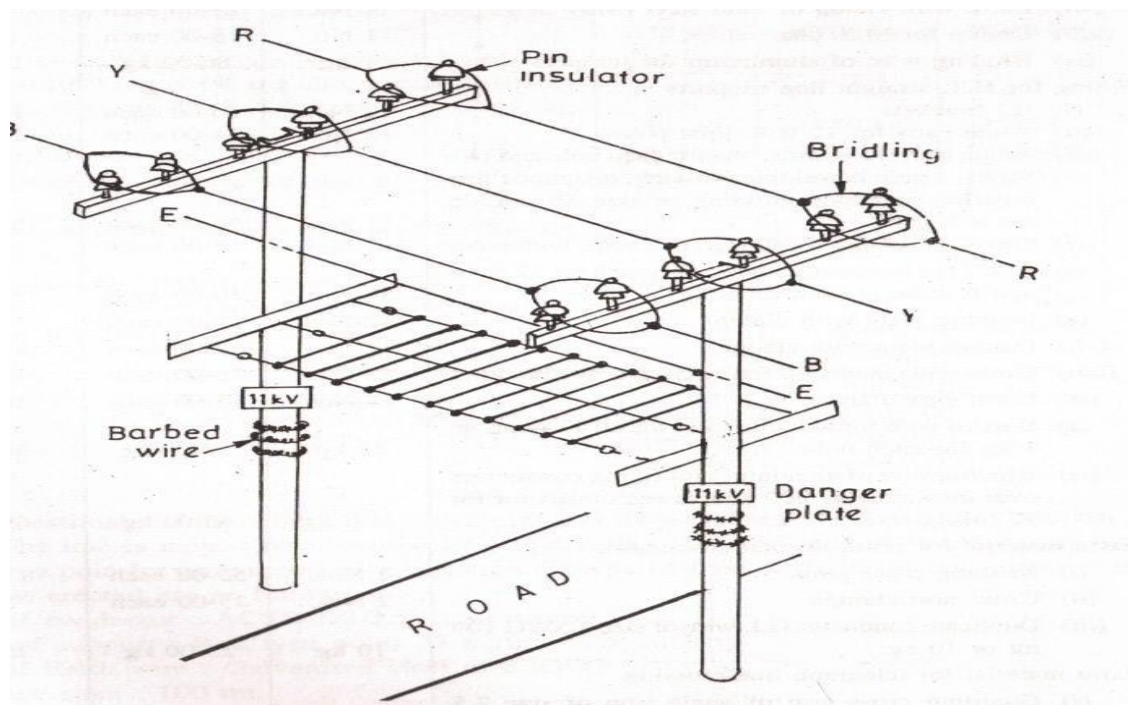
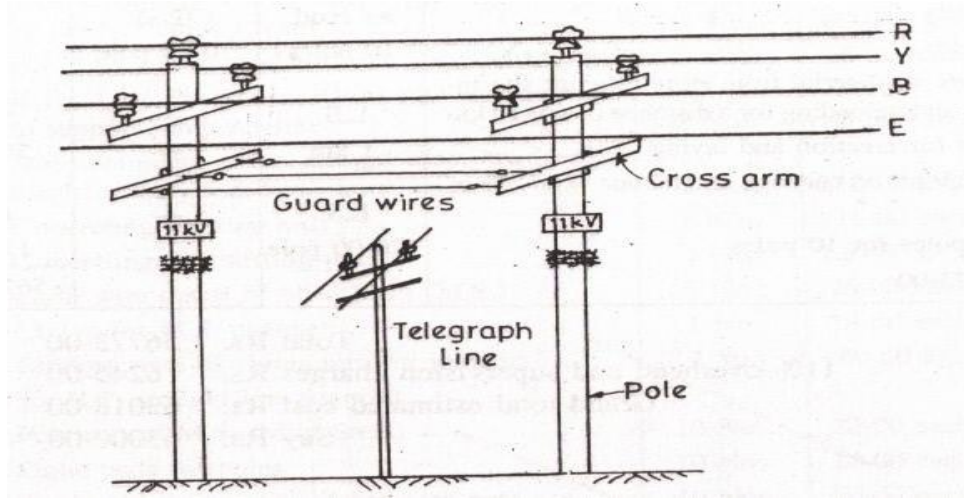

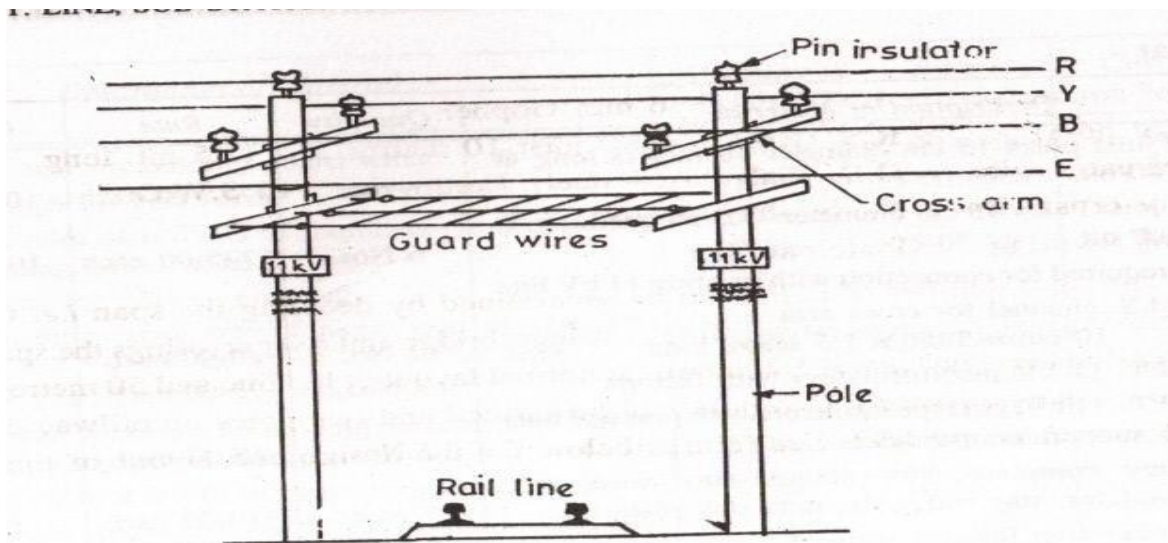
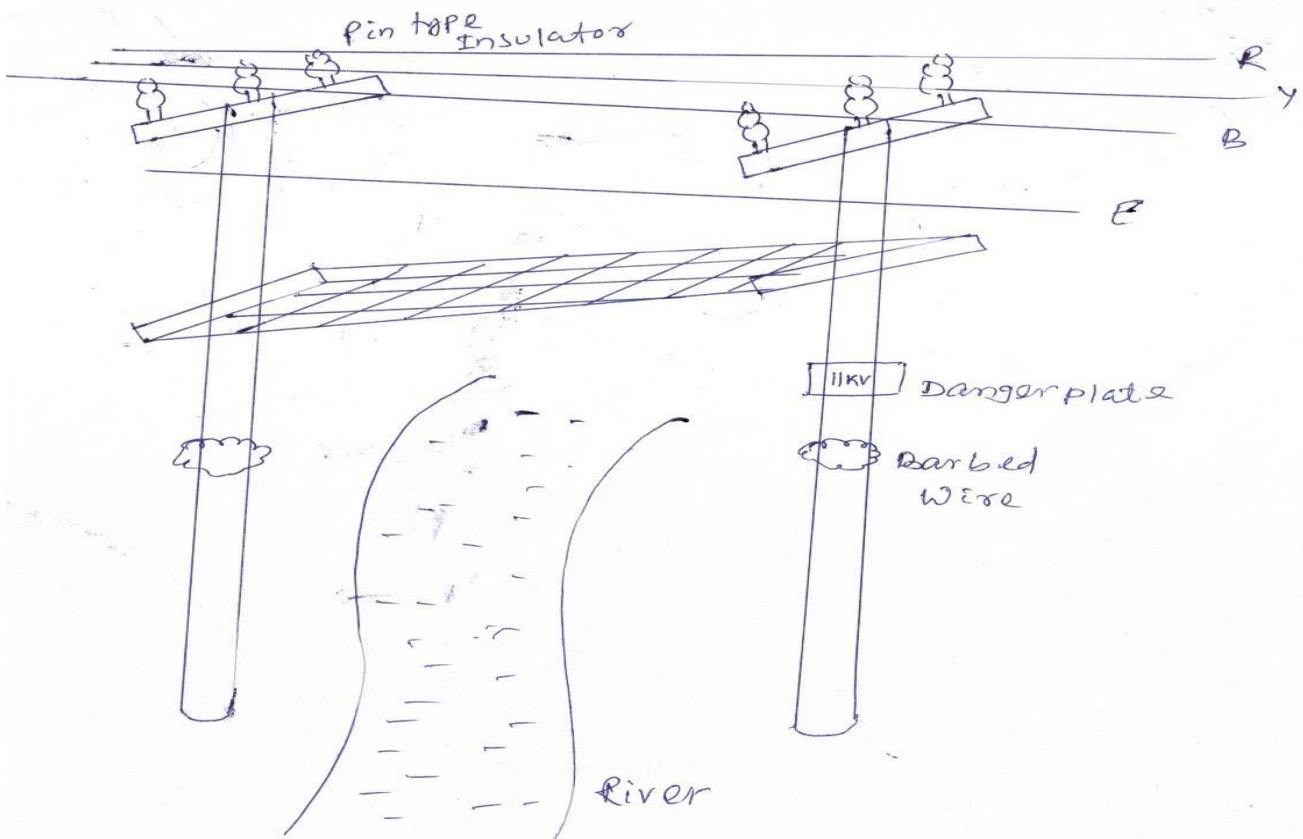

Fig. 22.11. Guarding for rail line



In the above question, No need to calculate Load current and voltage drop and Voltage Regulation because Size of conductor is already given.

$$\begin{aligned} \text{Total Length of Phase Wire} &= (1300 + 1\% \text{ sag} + 10\% \text{ of wastage}) \times \text{no of wire} \\ &= (1313 + 130) \times 3 = 4329\text{m} \end{aligned}$$

$$\begin{aligned} \text{Total length of Earth wire} &= (1300 + 1\% \text{ sag} + 10\% \text{ of wastage}) \times \text{no of wire} \\ &= 1443\text{m} \end{aligned}$$

**BILL OF MATERIAL**

SL NO	Specification of material	QTY
1	RS JOIST Line support 10 m long RS JOIST Line support 11.5 m long	5no 8 no
2	<b>Material required for connection with existing Line</b>	
a.	MS Channel for x arm (10cm×5cm×1.5m)	1 no
b	HT 11KV Disc insulator with fitting	3 no
C	HT 11KV Pin type insulator with fitting for jumpers	3 no
d	Stay set	2 no
E	Concreting for stay rod	2 no
F	Concreting for existing pole	1 no
G	MS Earth wire clamp	1 no
H	Clamp for MS Channel	1 no
I	Binding wire for jumpers	1 kg
3	<b>FITTINGS OF HT STRAIGHT LINE SUPPORT</b>	4set
A	L bracket	13 no
B	Stone pad for pole	13 no
C	Angle Iron cross arm 1 for each pole	13 no
D	Cross arm clamp	13 no
E	11 KV Pin type insulator with fitting	45 nos
F	Number plate	13 no
G	Danger plate with clamp	13 no
H	Earth wire clamp	13 no
I	Barbed wire	15kg
J	Binding wire	10 kg
4	ACSR Conductors 6/1×2.59	4329m
5	GI Earth wire 7/16 SWG	1443M
6	Complete eathing set	3 no
7	<b>Extra materials for poles at road crossing</b>	
A	Bridling cross arm	2 no
B	Cross arm clamp	2 no
C	Duplicate conductor GI Wire of size 8 SWG	10KG
7	Concreting for 11 poles	As per reqd
8	<b>Extra materials for poles at Telegraph line crossing</b>	
A	Guarding cross arm (7.5cm×7.5cm×1 cm ×1m)	2 no
B	Eye bolt for holding guard wire	8 no
C	Duplicate conductor GI Wire of size 8 SWG	20kg
D	Cross arm clamp	2 no
9	<b>Extra materials for poles at Railway line crossing</b>	
A	Guarding cross arm (7.5cm×7.5cm×1 cm ×2m)	2 no
B	Eye bolt for holding guard wire	12 no
C	Duplicate conductor GI Wire of size 8 SWG	40 kg
D	Cross arm clamp	2 no
10	<b>Extra materials for poles at River crossing</b>	
A	Guarding cross arm (7.5cm×7.5cm×1 cm ×2m)	2 no
B	Eye bolt for holding guard wire	12 no
C	Duplicate conductor GI Wire of size 8 SWG	40 kg
D	Cross arm clamp	2 no
11	Labour charges	As per reqd
12	Contingency chages	5% of total cost
13	Concreting for 11 poles	As per reqd

4. Estimate the cost of a pole mounted substation of capacity 50KVA Transformer of rating 11/0.4 KV. The HT line is available about 50 m from the proposed site. Also make neat sketch of the pole mounted substation.

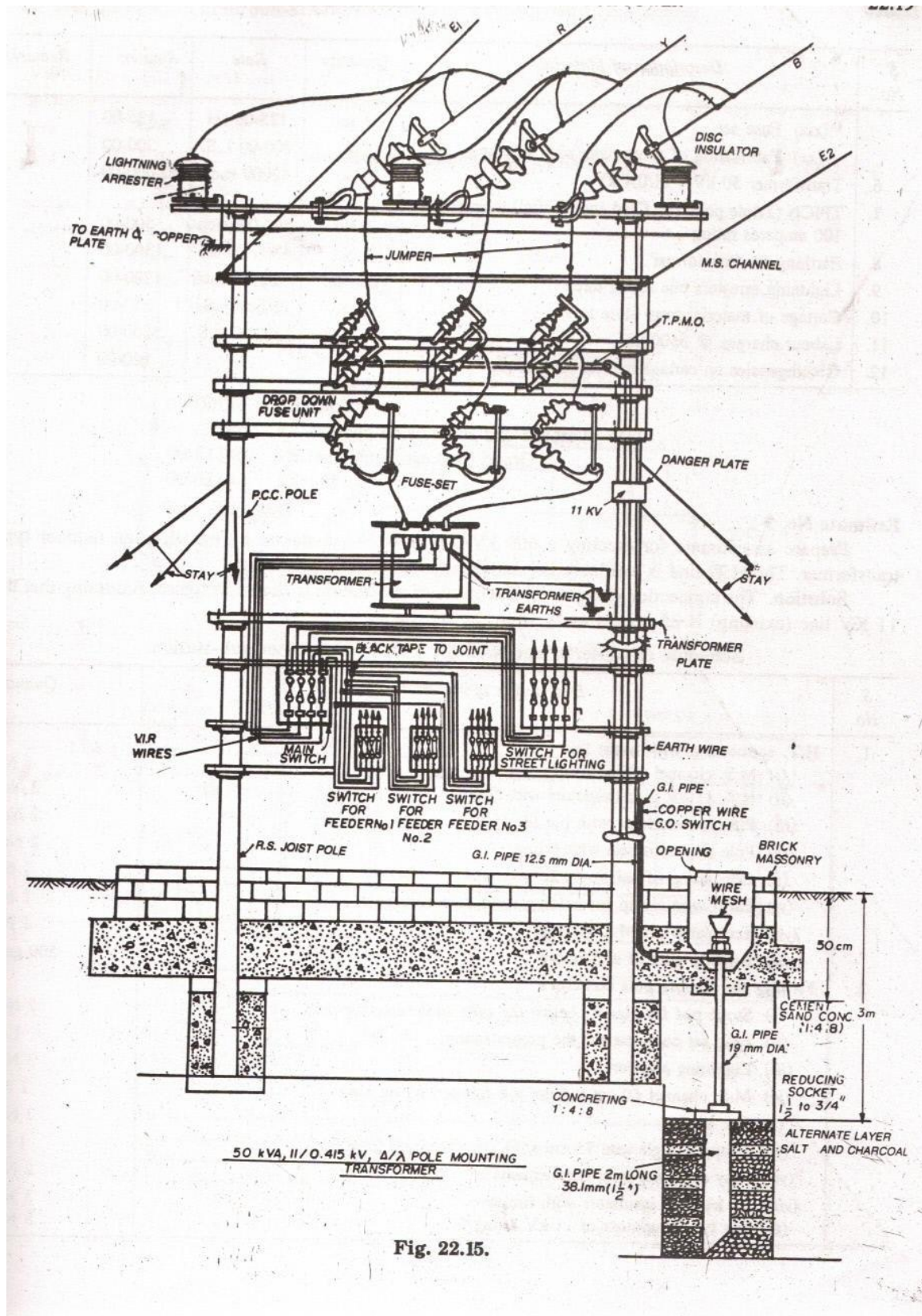

Line current for Primary Side of transformer= $50 \times 1000 / (\sqrt{3} \times 11000) = 2.62A$

Safe load current =  $2.62 \times 1.5 = 3.93A$

Referring ACSR conductor chart, it is suggested that 6/1×2.11mm stranded conductor may be selected for LT line.

Line current for Secondary Side of transformer= $50 \times 1000 / (\sqrt{3} \times 400) = 72.16A$

Safe load current =  $72.16 \times 1.5 = 108.253A$

Referring ACSR conductor chart, it is suggested that 6/1×2.36mm stranded conductor , Gopher may be selected for secondary side of transformer.

Total Length of Phase Wire =  $(50 + 1\% \text{ sag}) \times \text{no of wire}$

$$= (50.5) \times 3 = 151.5m$$

Total length of Earth wire =  $(50 + 1\% \text{ sag}) \times \text{no of wire}$

$$= 50.5m$$

### **BILL OF MATERIAL**

<b>SL NO</b>	<b>Specification of material</b>	<b>QTY</b>
1	RS JOIST Line support 10 m long	5no
2	<b>Material required for HT connection with existing Line</b>	
a.	MS Channel for x arm (10cm×5cm×1.5m)	1 no
b	HT 11KV Disc insulator with fitting	3 no
C	HT 11KV Pin type insulator with fitting for jumpers	3 no
d	Stay set	2 no
E	Concreting for stay rod	2 no
F	Concreting for existing pole	1 no
G	MS Earth wire clamp	1 no
H	Clamp for MS Channel	1 no
I	Binding wire for jumpers	1 kg
3	<b>FITTINGS OF HT DOUBLE POLE STRUCTURE FOR POLE MOUNTED SUBSTATION</b>	4set
A	Sub station plate	1 no
B	Stone pad for pole	2 no
C	MS Channel 100mm×50mm×8mm×2.65mt long	1 no
D	Eye bolt	3 no
E	11 KV Pin type insulator with fitting	3 nos
F	Number plate	13 no
G	Danger plate with clamp	13 no
H	Earth wire clamp	13 no
I	Barbed wire	15kg
J	Binding wire	10 kg
K	11 KV Disc type insulator with fitting	3 no
L	Dropper angle iron 75mm×75mm×8mm×2mt long	1 no
M	Jumper wire for jumpering	11mt
N	TPMO SWITCH	1 No
O	Painting of poles	2 lit
P	Fuse set	1 set
Q	Fabrication of some parts	As per reqd
4	ACSR Conductors 6/1×2.11	151.5m
5	GI Earth wire 7/16 SWG	50.5m
6	Complete eathting set	3 no
7	<b>Transformer 50KVA 11/0.4 KV</b>	1 NO
8	TPICN MS,100A	1 NO
9	Earthing for transformer	1 no
10	Lightning arrester	3 set
11	Transportation charges	As per reqd
12	Labour charges	As per reqd

13	Contingency chages	5% of total cost
14	Concreting for 11 poles	As per reqd

juui

4. Estimate the cost of a plinth mounted substation of capacity 100 KVA TRANSFORMER of rating 11/0.4 KV. The HT line is available about 100 m from the proposed site. Also make neat sketch of the pole mounted substation.

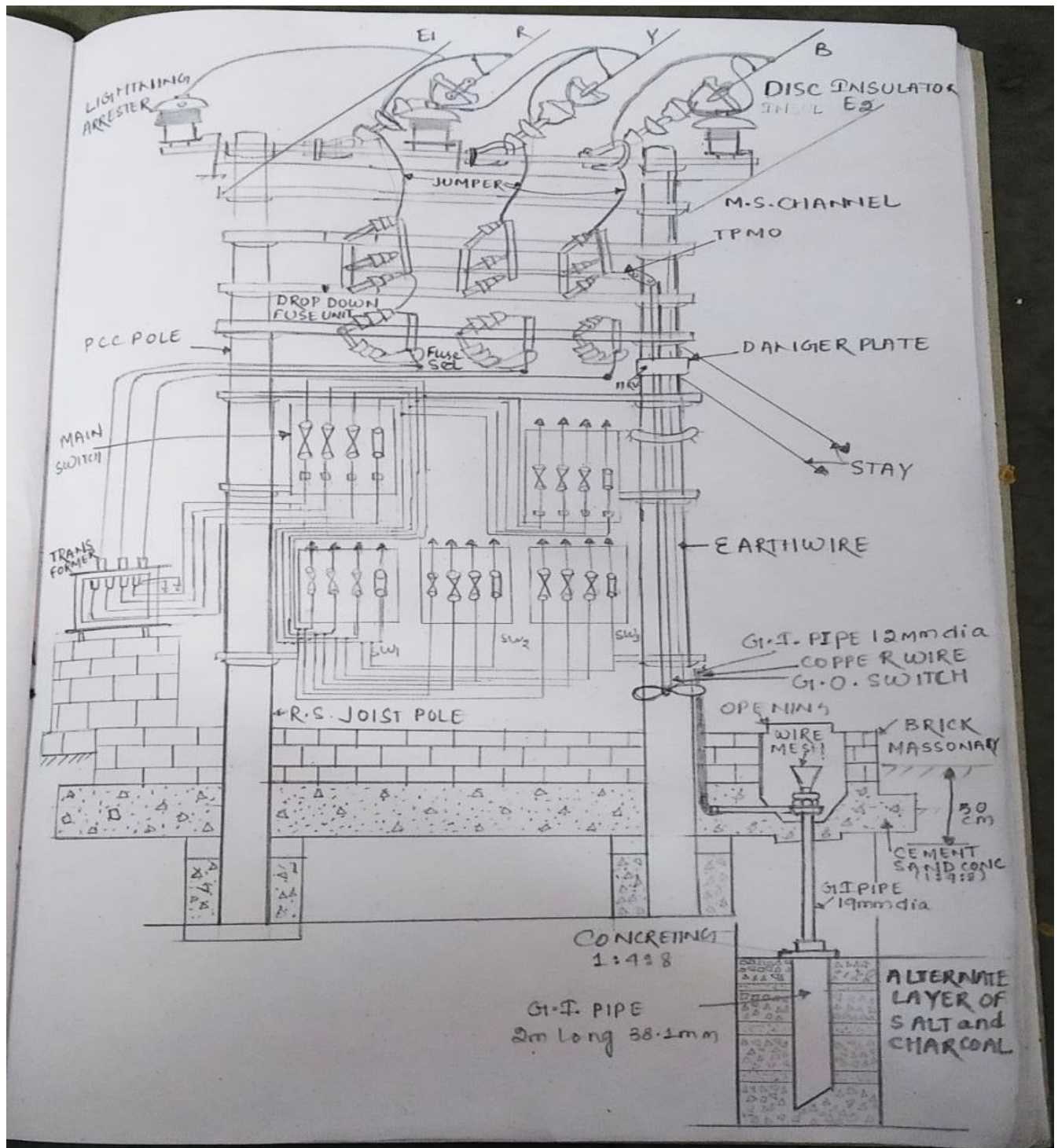

Line current for Primary Side of transformer= $100 \times 1000 / (\sqrt{3} \times 11000) = 5.25A$

Safe load current =  $5.25 \times 1.5 = 7.9A$

Referring ACSR conductor chart, it is suggested that 6/1×2.11mm stranded conductor may be selected for LT line.

Line current for Secondary Side of transformer= $100 \times 1000 / (\sqrt{3} \times 400) = 144A$

Safe load current =  $144 \times 1.5 = 216A$

Referring ACSR conductor chart, it is suggested that 6/1×3.66mm stranded conductor, Mink may be selected for secondary side of transformer.

Total Length of Phase Wire =  $(100 + 1\% \text{ sag}) \times \text{no of wire}$

$$= (101) \times 3 = 303m$$

Total length of Earth wire =  $(100 + 1\% \text{ sag}) \times \text{no of wire}$

$$= 101m$$

### **BILL OF MATERIAL**

SL NO	Specification of material	QTY
1	RS JOIST Line support 10 m long	5no
2	<b>Material required for HT connection with existing Line</b>	
a.	MS Channel for x arm (10cm×5cm×1.5m)	1 no
b	HT 11KV Disc insulator with fitting	3 no
C	HT 11KV Pin type insulator with fitting for jumpers	3 no
d	Stay set	2 no
E	Concreting for stay rod	2 no
F	Concreting for existing pole	1 no
G	MS Earth wire clamp	1 no
H	Clamp for MS Channel	1 no
I	Binding wire for jumpers	1 kg
3	<b>FITTINGS OF HT DOUBLE POLE STRUCTURE FOR POLE MOUNTED SUBSTATION</b>	4set
A	Sub station plate	1 no
B	Stone pad for pole	2 no
C	MS Channel 100mm×50mm×8mm×2.65mt long	1 no
D	Eye bolt	3 no
E	11 KV Pin type insulator with fitting	3 nos
F	Number plate	13 no
G	Danger plate with clamp	13 no
H	Earth wire clamp	13 no
I	Barbed wire	15kg
J	Binding wire	10 kg
K	11 KV Disc type insulator with fitting	3 no
L	Dropper angle iron 75mm×75mm×8mm×2mt long	1 no
M	Jumper wire for jumpering	11mt
N	TPMO SWITCH	1 No
O	Painting of poles	2 lit
P	Fuse set	1 set
Q	Fabrication of some parts	As per reqd
R	AB Switch set	1 no
4	ACSR Conductors 6/1×2.11	303m
5	GI Earth wire 7/16 SWG	101m
6	Complete eathing set	3 no
7	<b>Transformer 100 KVA 11/0.4 KV</b>	1 NO
8	TPICN MS,250A	1 NO
9	Earthing for transformer	1 no

10	Lightning arrestor	3 set
11	Concrete for plinth 1:2:4	As per reqd
12	Bricks	As per reqd
13	Barbed wire for boundary of plinth	50kg
14	Transportation charges	As per reqd
15	Labour charges	As per reqd
16	Contingency chages	5% of total cost